

Instruction and Operation Manual

S132

Laser Particle Counter



Dear Customer,

Thank you for choosing our product.

Before you start up the device please read this manual in full and carefully observe instructions stated in this manual. The manufacturer cannot be held liable for any damage that occurs as a result of non-observance or non-compliance with this manual.

Should the device be tampered with in any manner other than a procedure that is described and specified in the manual, the warranty is void and the manufacturer is exempt from liability.

The device is destined exclusively for the described application.

SUTO offers no guarantee for the suitability for any other purpose. SUTO is also not liable for consequential damage resulting from the delivery, capability or use of this device.

Reversion: 2025-2



Last modifications: January, 2025

Table of Contents

1	Safety instructions.....	5
2	Registered trademarks.....	7
3	Application.....	8
4	Features.....	8
5	Technical data.....	9
5.1	General data.....	9
5.2	Electrical data.....	9
5.3	Output signals.....	10
5.4	Counting efficiency.....	10
5.5	Procedure of general particle counting	10
6	Dimensional drawing.....	11
7	Installation	12
7.1	Installation methods.....	12
7.2	Installation procedure	14
7.3	Electrical connection.....	16
7.3.1	M12 connector.....	16
7.3.2	RJ-45 connector.....	17
8	Configuration	18
8.1	Integrated display.....	18
8.2	Service kit.....	18
8.3	External display	18
9	Operation using the integrated display.....	19
9.1	Value view.....	19
9.2	Icons in the status bar.....	20
9.3	Trend view.....	21
9.4	Menu.....	22
9.5	Sensor settings.....	23
9.5.1	Analog output.....	23
9.5.2	Counter setting.....	24
9.5.3	Alarm settings.....	25
9.5.4	Modbus settings.....	26
9.5.5	Sensor Info.....	26
9.6	Guided Measurement with PDF Report Generation.....	27
9.7	Service Information.....	27
10	Guided measurement.....	28
10.1	Steps for guided measurement.....	29
10.2	Reports for guided measurements.....	32
11	LED indicators at the front panel.....	33
12	Signal outputs.....	34
12.1	Analog output	34
12.2	Modbus Interface.....	34

12.3 Alarm output36
13 Optional accessories.....37
14 Calibration.....38
15 Maintenance.....39
16 Disposal or waste.....39

1 Safety instructions

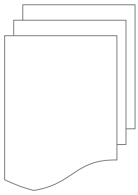

Please check if this instruction manual matches the product type.

Please observe all notes and instructions indicated in this manual. This manual contains essential information that must be observed before and during installation, operation and maintenance. Therefore this manual must be read carefully by the technician as well as by the responsible user or qualified personnel.

This instruction manual must be available at the operation site of the product at any time. In case of any obscurities or questions regarding this manual or the product, please contact the manufacturer.

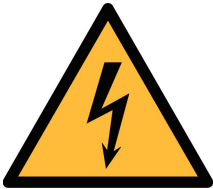

WARNING!

Compressed air!

Any contact with quickly escaping air or bursting parts of the compressed air system can lead to serious injuries or even death!

- Do not exceed the maximum permitted pressure range (see sensors label).
- Use only pressure-tight installation material.
- Prevent persons from being hit by escaping air or bursting parts of the instrument.
- The system must be pressureless during maintenance work.

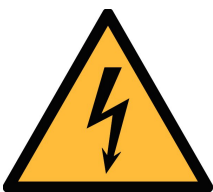

WARNING!

Voltage used for supply!

Any contact with energized parts of the device may lead to an electrical shock which can lead to serious injuries or even death!

- Consider all regulations for electrical installations.
- The system must be disconnected from any power supply during maintenance.
- Any electrical work on system is allowed only by authorized qualified personal.

**ATTENTION!****Permitted operating parameters!**

Observe the permitted operating parameters. Any operation beyond these parameters can lead to malfunctions and may lead to damage on the product or the system.

- Do not exceed the permitted operating parameters.
- Make sure that the product is operated under its permitted conditions.
- Store and operate the product at the permitted temperature and pressure.
- The product should be maintained and calibrated frequently, at least annually.

General safety instructions

- It is not allowed to use the product in explosive areas.
- Please observe the national regulations before and during installation and operation.

Remark

It is not allowed to disassemble the product.

**ATTENTION!****Measurement values can be affected by malfunction!**

The product must be installed properly and maintained frequently. Otherwise it may lead to wrong measurement values, which can lead to wrong results.

Storage and transportation

- Make sure that the transportation temperature for the product without display is between -10 ... +50°C.
- It is recommended to use the packaging that comes with the product for storage and transportation.
- Make sure that the storage temperature of the product is between -10 ... +50°C.
- Avoid direct UV and solar radiation during storage.

- The storage humidity must be $< 90\%$ with no condensation.



ATTENTION!

Equipment may get damaged!

Please make sure, that your measuring point is free of excessive contamination and dirt. This should be maintained before every measurement.

- Observe the measuring point always before measurement if it is free of contamination like water drops, oil drops or other rough contamination.
- Should water hit the inner electronics, the sensors could be seriously damaged.
- Before you start to measure, check your measurement point by using a simple filter to see if any rough contamination is present. (Example of such a test device is shown below. Ask the supplier if not sure.)

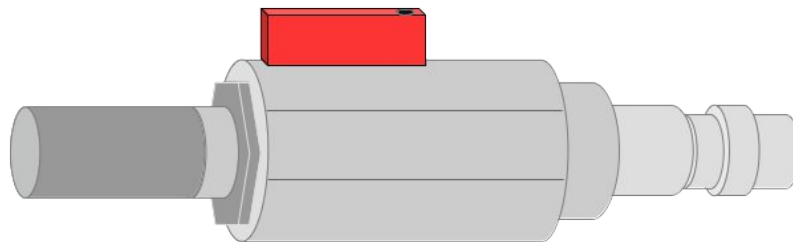

2 Registered trademarks

SUTO®	Registered trademark of SUTO iTEC
MODBUS®	Registered trademark of the Modbus Organization, Hopkinton, USA
Android™, Google Play	Trademarks of Google LLC

3 Application

The S132 is a laser particle counter, which is designed to measure particles in compressed air or compressed gases. For the permissible operating parameters, see chapter [5 Technical data](#).

The S132 can measure the quantity or mass of particles per volume in the unit of cn/ft^3 , cn/m^3 , or mg/m^3 . You can choose the unit setting as needed by using the optional integrated display, an external display, or the service kit.

The S132 laser particle counter is mainly used in compressed air systems in industrial environments, and is not designed for use in explosive areas. To use it in explosive areas, please contact the manufacturer.

4 Features

- Measures particle content in compressed air or compressed gases.
- Easy connection through sampling hose and quick connector.
- Applicable to stationary or portable applications.
- Measures particles larger than $0.1 \mu\text{m}$.
- Report generator creates PDFs for audits.
- Compliance with ISO 8573-4.
- Service indication through LED.
- Connectable to display and data logger produced by the manufacturer and by third-party manufacturers.
- IP65 casing provides robust protection in rough industrial environments.
- Optional integrated display for monitoring and configuration.

5 Technical data

5.1 General data

CE	
Measuring channels	CH1: $0.1 < d \leq 0.5 \mu\text{m}$ CH2: $0.5 < d \leq 1.0 \mu\text{m}$ CH3: $1.0 < d \leq 5.0 \mu\text{m}$ CH4: $5.0 \mu\text{m} < d$ (configurable)
Measurement unit	cn/ft ³ , cn/m ³ , mg/m ³ cn indicates particle counts
Principle of measurement	Laser detection
Sensor	LED-laser
Measured medium	Compressed air
Flow rate	2.83 l/min
Sample rate	1 minute sampling time (Values are updated every one minute.)
Ambient temperature	0 ... +50°C
Humidity of the measured medium	< 90% rH, no condensation
Operating pressure	0.3 ... 1.5 MPa
Housing material	PC, Al alloy
Protection class	IP65
Dimensions	See the dimensional drawing on page 11 .
Display & data logger (optional)	5" touch screen, 800 x 480 pixels 100 million values
Weight	3.2 kg

5.2 Electrical data

Power supply	24 VDC, 10 W without display 24 VDC, 20 W with display
--------------	---

5.3 Output signals

Analogue output	4 ... 20 mA
Digital output	RS-485, Modbus/RTU Modbus/TCP(with display version)
Alarm output	NO, 40 VDC, 0.2 A

5.4 Counting efficiency

Counting efficiency per ISO 21501-4	30 ... 70% of $d > 0.1 \mu\text{m}$ 90 ... 110% of $d \geq 0.3 \mu\text{m}$
--	--

5.5 Procedure of general particle counting

1. The S132 does not count any particles in the first 5 minutes. During this period, it performs a purge process to ensure that any remaining particles in the system are blown out.
2. After purging, the S132 starts sampling at a sampling interval of 1 minute.
 - a. In the next 40 minutes, S132 classifies the sampled values based on particle sizes and then accumulates them.
 - b. After the 40 minutes, every one minute (sampling interval), S132 removes the earliest sample values from the accumulated values, and then add the latest sampled value into the accumulated values to obtain the accumulated particle values within the last 40 minutes.

6 Dimensional drawing

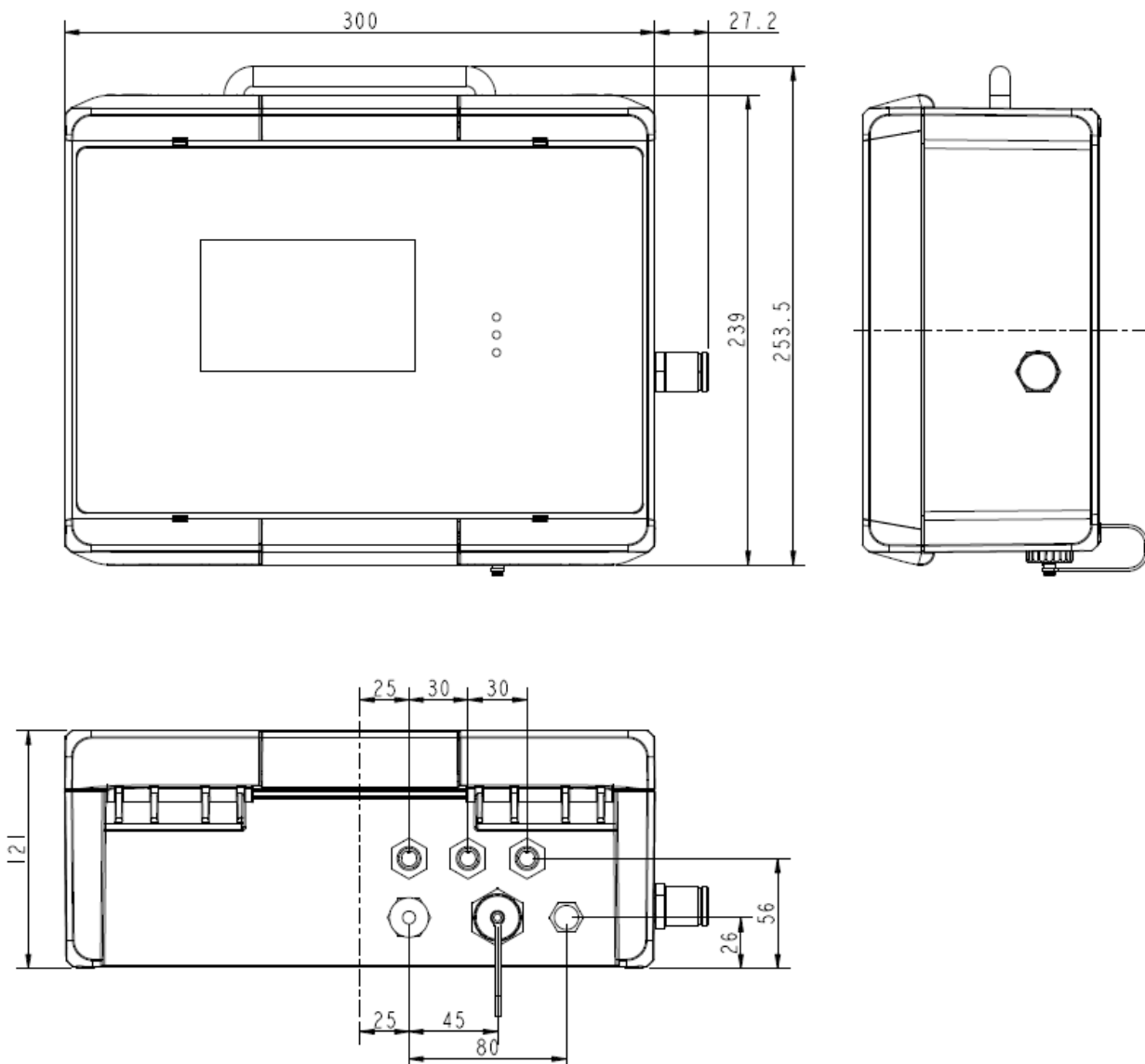

7 Installation

Please make sure that all components listed below are included in your package.

Qty	Description	Item No.
1	S132 Laser Particle Counter *	S604 1308 / S604 1309
3	M12 connectors or M12 cables (depending on orders)	Connector: C219 0059 Cable: A553 0104 / A553 0105
1	1.5 m teflon hose with a quick connector	A554 0003
1	Purge filter for pre-measurement (test kit)	A554 0604
1	Power supply	A554 0108
1	Mounting brackets	No P/N
1	Instruction manual	No P/N
1	Calibration certificate	No P/N

* S604 1309 has an integrated display and data logger while S604 1308 does not.

7.1 Installation methods

S132 can be used as a stationary or portable instrument.

S132 comes with four mounting brackets. In the stationary installation, mount the brackets from the backside of the instrument at each corner. The brackets enable you to install the instrument on the wall easily. The following are dimensional drawings of two installing methods.

Method 1

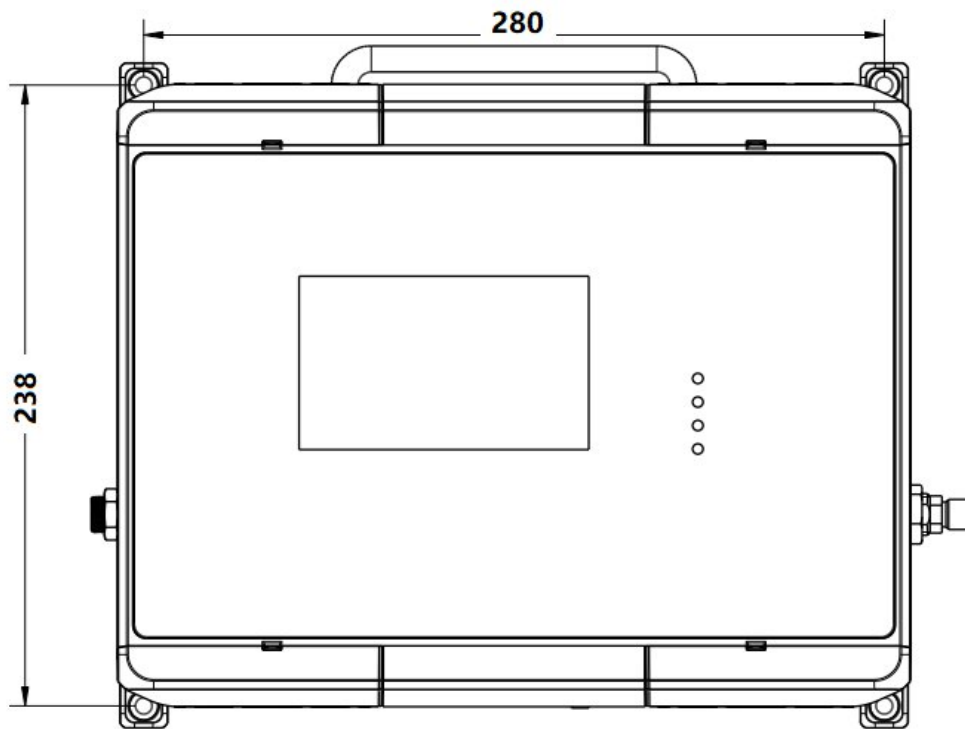

Method 2

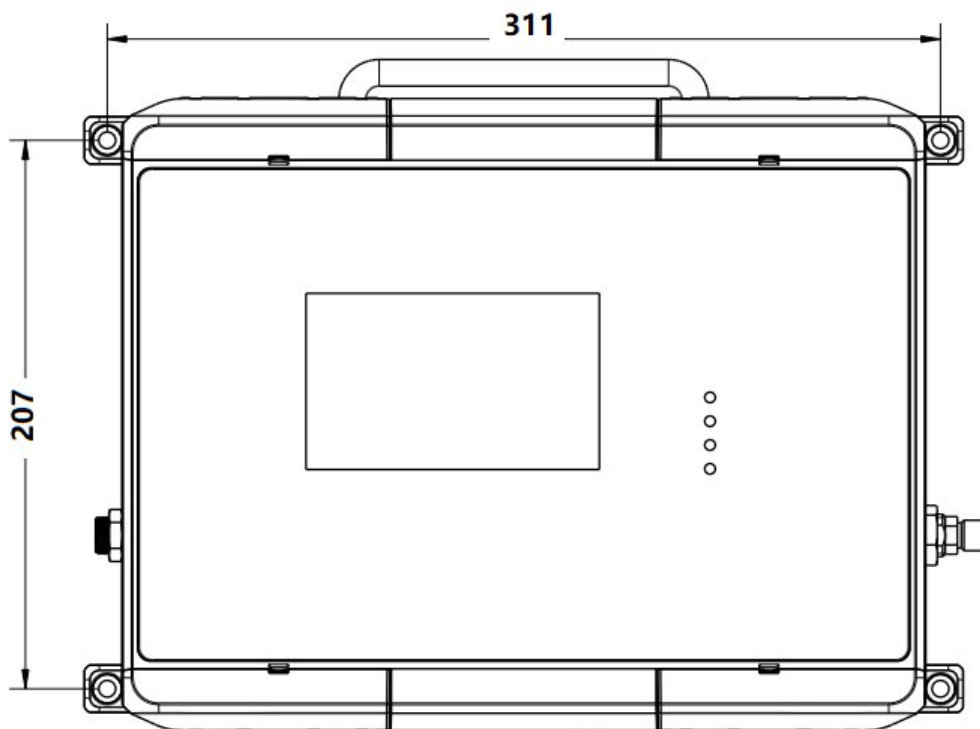

7.2 Installation procedure



ATTENTION!

Before you connect the device to your point of measurement, make sure that there is no rough contamination like water/oil drops or heavy dust. This may damage the sensor units. For this please use the purge filter test kit.

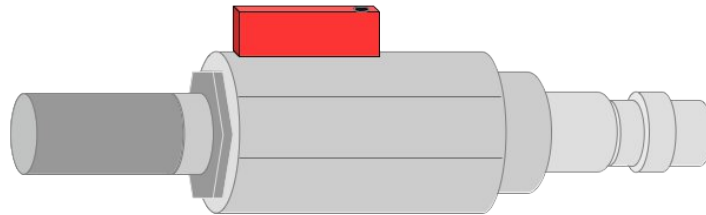

Steps to check:

1. Connect the purge filter test kit onto your measuring point first. Open the purge valve on the test kit and purge air for a short period.
2. Check the filter in the test kit to see whether it shows high contamination of water, oil or dust.
3. If the filter is contaminated severely, stop using the S132 for measurement because this may lead to serious damage to the device. In case you are not sure, please contact the manufacturer.

The following steps explain the procedure of an appropriate installation.



1. Connect the teflon hose with the inlet of the S132 as shown in the left figure.



2. Connect the quick connector on the other end of the teflon hose with the process.

Please consider the following recommendations for a successful measurement result:

- All components from the sampling point to the S132 must be oil and grease free.
- Ambient and gas temperature must be within the specified ranges.
- The inlet gas must be pressurized with the valid ranges.
- The sampling gas must be dry (< 90% rH) and clean.
- Ensure that valves at the sampling point are not lubricated.



ATTENTION!

Avoid contamination with oil or grease!

It will lead to very slow measurement or impossible measurement results!

7.3 Electrical connection

The S132 comes with three M12 connectors A, B, C, and a RJ-45 connector.

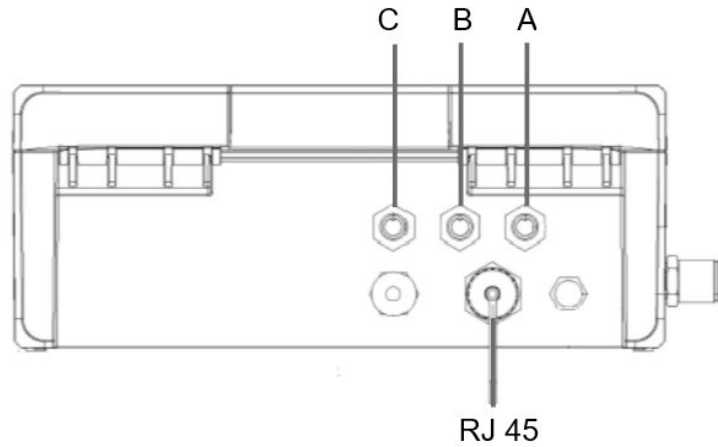

7.3.1 M12 connector

Pin assignment

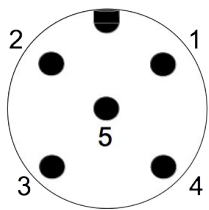

Front view

Connector	Pin 1	Pin 2	Pin 3	Pin 4	Pin 5
A	SDI	$-V_b$	$+V_b$	+D	-D
B	PE	$-V_b$	$+V_b$	+I	-I
C	Relay	Relay	GND	+D	-D
	brown	white	blue	black	grey

Legend:

SDI	Digital signal (internal use)
$-V_B$	Negative supply voltage
$+V_B$	Positive supply voltage
+I	Positive 4 ... 20 mA signal
-I	Negative 4 ... 20 mA signal
+D	RS-485, Modbus / RTU
-D	RS-485, Modbus / RTU
Relay	Alarm output
PE	Protective Earth
GND	Communication ground

Connection to the following external display units

S132				S330/S331	
Terminal	Pin	Signal	Color code	Terminal	Pin
A	1	SDI	brown	A/B	1
	2	-V _b	white		2
	3	+V _b	blue		3
	4	+D	black		4
	5	-D	grey		5

S132				S320	
Terminal	Pin	Signal	Color code	Terminal	Pin
A	1	SDI	brown	G	6
	2	-V _b	white		7
	3	+V _b	blue		8
	4	+D	black		
	5	-D	grey		

7.3.2 RJ-45 connector

The RJ-45 Ethernet connector allows the S132 to be connected to a TCP/IP network.

Note: Check the Modbus TCP communication parameters via **Menu > Communication > Field-bus TCP**.

8 Configuration

The S132 is delivered with standard factory settings (as shown below) or specific customer settings according to the order.

Scaling	: 4 mA = 0 20 mA = 100000 cn/m ³
Alarm	: NO, 40 VDC, 0.2 A
Modbus	: Device address = Last two digits of the serial number Baudrate = 19200 Framing/parity/Stop bit = 8, N, 1 Transmission mode = RTU

You can change the settings using the following devices.

8.1 Integrated display

If the S132 comes with a display (Item No: S604 1309), you can configure the settings directly using the display. For more information, see chapter [9 Operation using the integrated display](#).

8.2 Service kit

If the S132 does not come with a display (Item No: S604 1308), you can configure the S132 using the optional service kit.

For more information, please see chapter [13 Optional accessories](#).

8.3 External display

If you have the S330/S331 display available, you can connect the S132 with S330/S331 via SDI, and change the settings using this display. See the instruction manual of the S330/S331 for details.

9 Operation using the integrated display

If the S132 comes with a display (Item No: S604 1309), you can view particle counts in real-time and configure the S132 using the display.

9.1 Value view

After the S132 is powered on and initialized, the screen displays the value view as shown below.

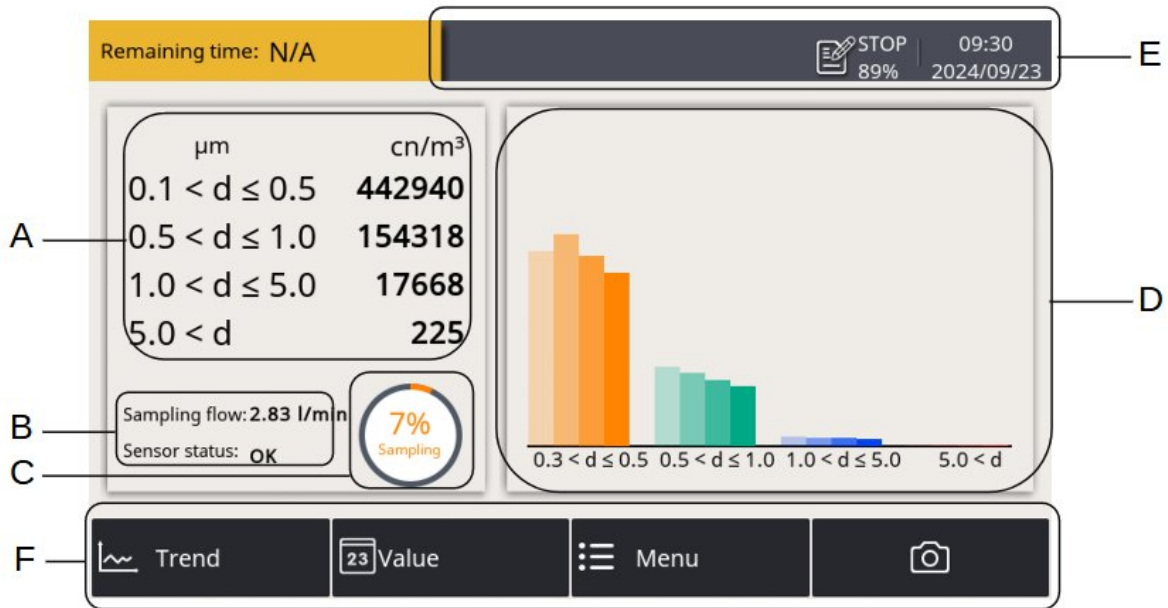







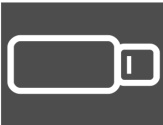

Area

Description

- | Area | Description |
|------|--|
| A | Shows the actual sampling result in all sizing channels. |
| B | Shows the sampling status as follows: <ul style="list-style-type: none"> • Sampling flow (0.1 CFM = 2.83 l/min) • Sensor status: <ul style="list-style-type: none"> ○ OK: Indicates that everything is normal. ○ Service: Indicates that this instrument needs to be serviced and you should contact the customer service. NOTE: "Service" may also be shown if the air is supplied with high concentration of particles or the supply pressure is below the required minimum pressure. In such cases, make sure that you operate in the specified pressure range and purge the sample air through the device for about ten minutes. If "service" is still displayed, please contact the customer service. |

Area	Description
C	Shows the progress of the sampling or purging process. The S132 purges sampled data in the first five minutes after powered on. During this period, the progress of "Purging" instead of "Sampling" is displayed.
D	Shows the last four particle counts of each channel in a bar graph.
E	Status bar, shows the S132 running status. For more information, see 9.2 Icons in the status bar .
F	Quick buttons and icon: <ul style="list-style-type: none"> • Trend: Click to switch to the graphic view where the four channels and their particle counts over a period of time are displayed in a line graph. • Value: Click to switch to the value view where the four channels and their particle counts are displayed in real time. • Menu: Click to switch to the main menu. For more information, see 9.4 Menu. • The camera icon: Click to capture the current screen. You can read out these screenshots through the USB port.

9.2 Icons in the status bar

	USB stick connected		System error
	Sensor connection has changed, not matching with configuration		Sensor unit is not matching with configuration
	Logger version		RTC backup battery status
	Sensor calibration is expired		Alarm triggered

9.3 Trend view

Shows the dynamic graphs of all measurements. To view the trend screen, press **Trend** in the bottom bar.

The trend view is pre-configured in the factory. You can view the S132 measurement graph without configuring anything. In case that you want to manipulate the graph, follow the instructions indicated in the following figure.

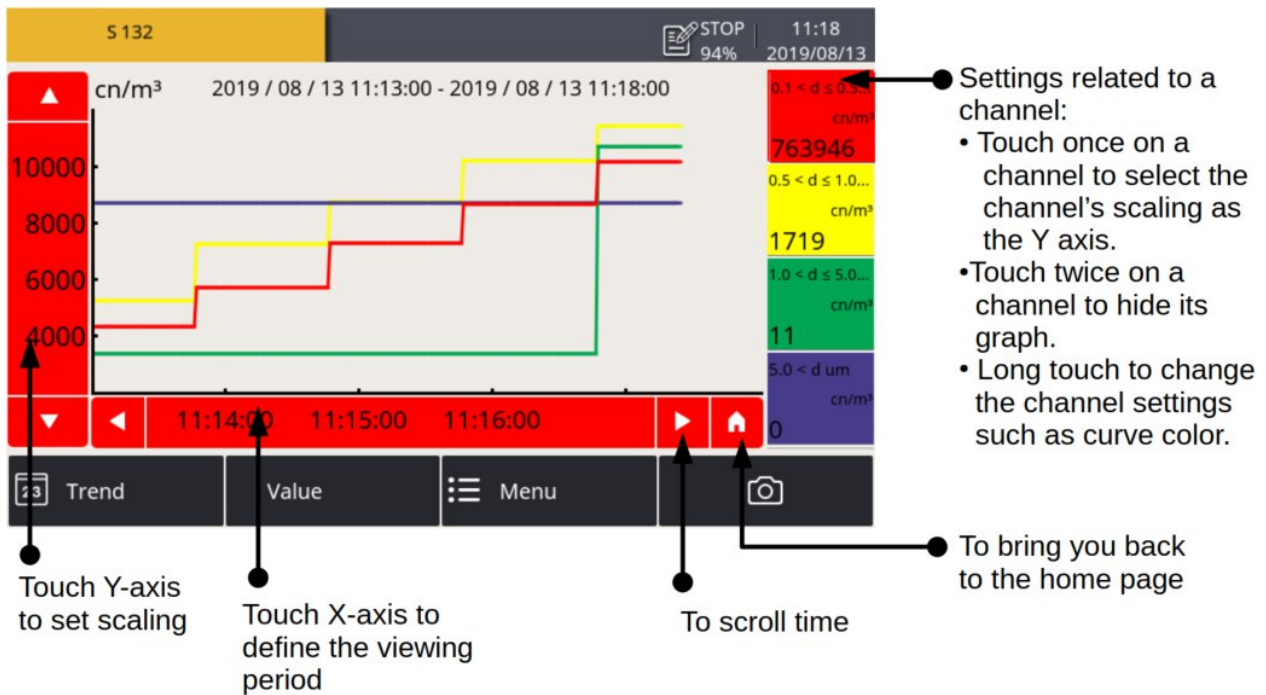

9.4 Menu

Enables you to change the S132 settings.

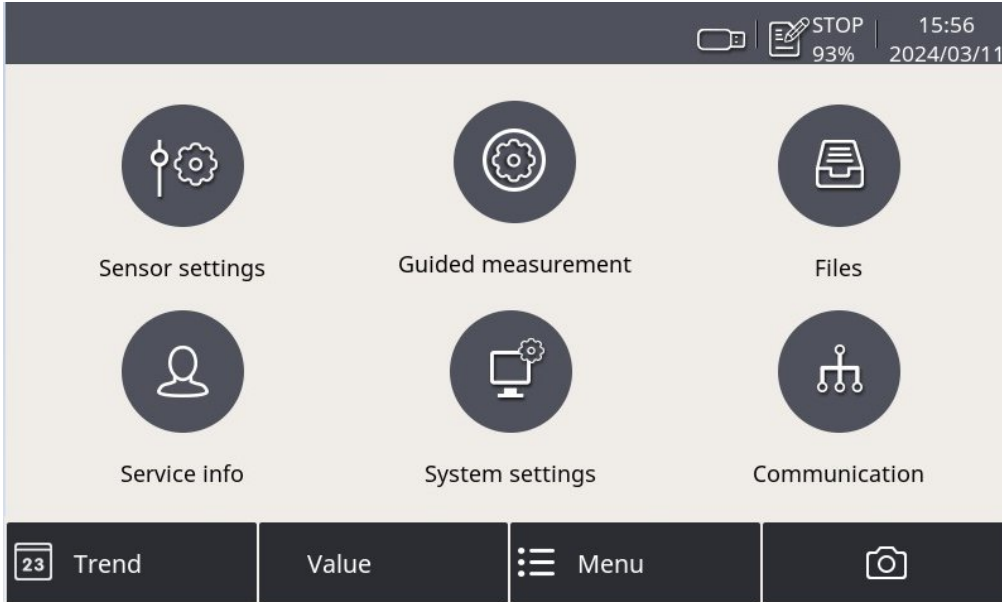

The menu consists of the following function buttons:

Sensor settings	To change the S132 sensor settings
Guided measurement	To start the guided measurements, which lead you through a complete measurement cycle.
Files	To manage all recorded files and to check the memory status
Service info	To view contact information of the service provider
System settings	To change other system-level settings such as the language setting
Communication	To configure Modbus master and field buses RS-485 and TCP related settings

9.5 Sensor settings

As stated in Chapter 7, the S132 is delivered with standard ex-factory configuration or with specific customer settings according to the order.

Before starting to measure, you can access sensor settings using the **Menu > Sensor settings** menu to view the sensor settings; and If needed, you can change these settings.

After making any changes to the settings, please remember to click the **Save** button.

9.5.1 Analog output

To change the ex-factory settings for the analog output. S132 provides only one analog output, which means only one measuring channel can be output using the 4 ... 20 mA signal.

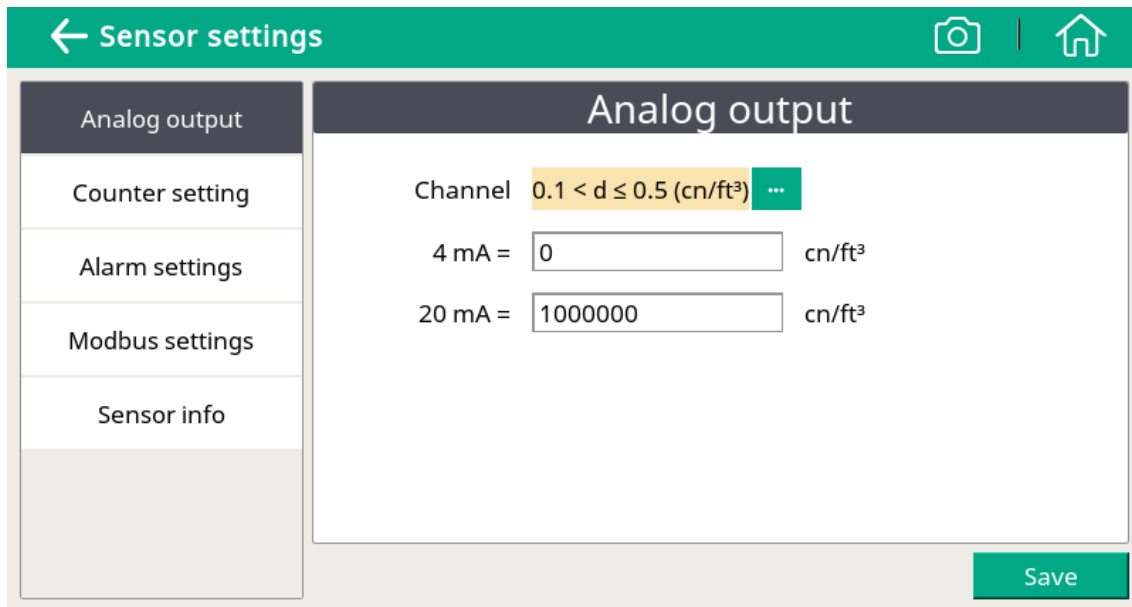

Channel	To select the channel that the S132 provides the analog output for
4 mA	To enter the particle count that 4 mA is scaled to
20 mA	To enter the particle count that 20 mA is scaled to

9.5.2 Counter setting

To change the ex-factory counter settings.

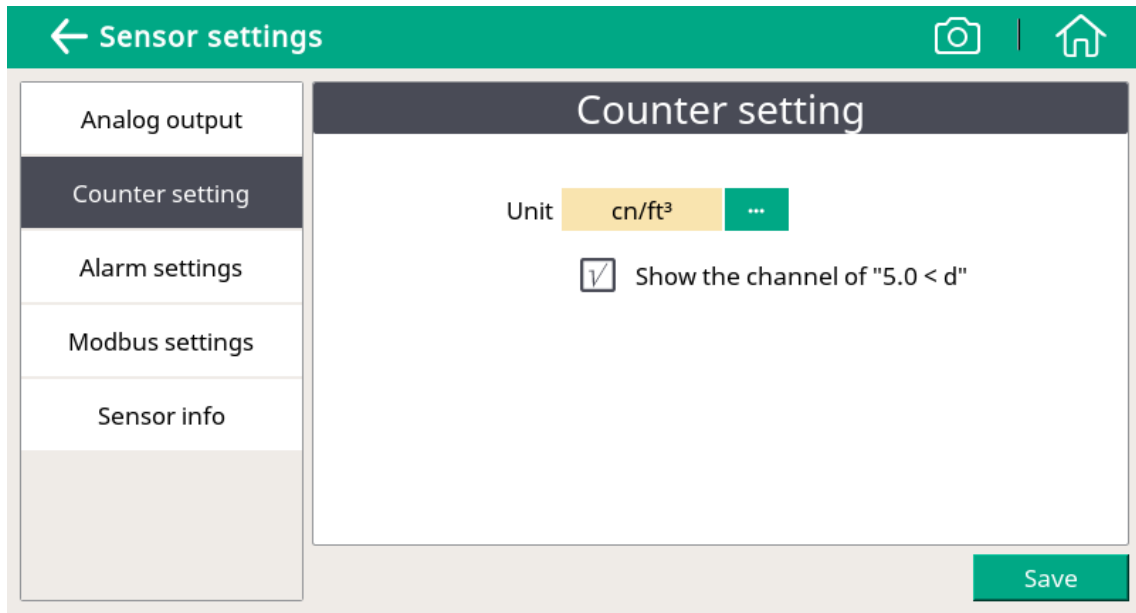

Unit To select the unit of the counter

Show the channel of "5.0<d" To show or hide the "5.0<d" channel on the screen

9.5.3 Alarm settings

S132 provides one alarm relay output through the pin 1 and 2 of connector C (NO, 40 VDC, 0.2 A). You can use this output to trigger an external alarm device.

The Alarm settings menu enables S132 to trigger the alarm output based on particle counts in specified channels.

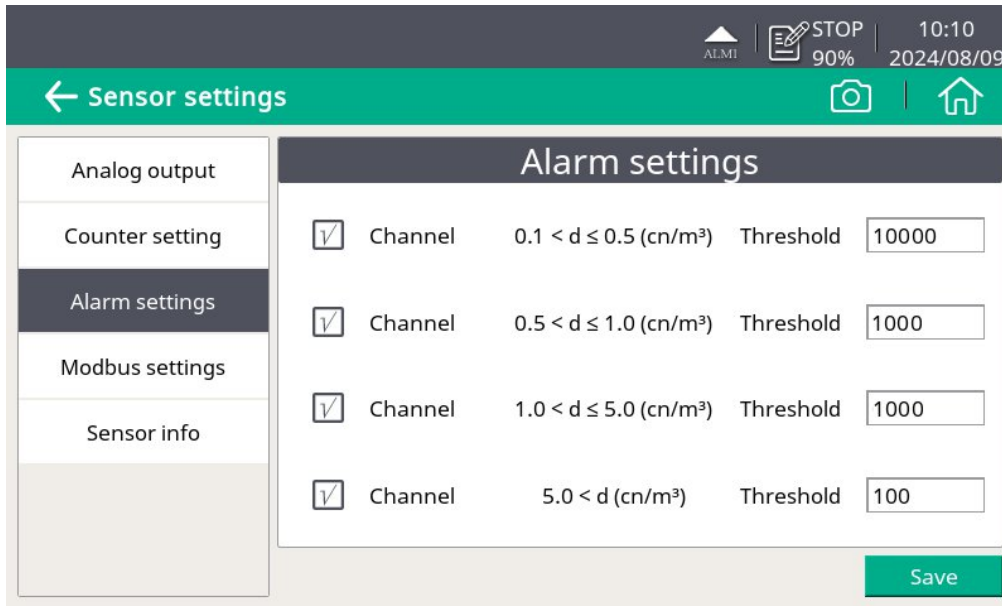

If the user selects alarm-enabled channels, the relay is triggered when an alarm occurs on any of the alarm-enabled channels.

Enable alarm To enable or disable the alarm output.

Channel To select a channel that is monitored to trigger the alarm output.

Threshold To enter the alarm threshold for the monitored channel.

9.5.4 Modbus settings

To change the ex-factory Modbus/RTU settings.

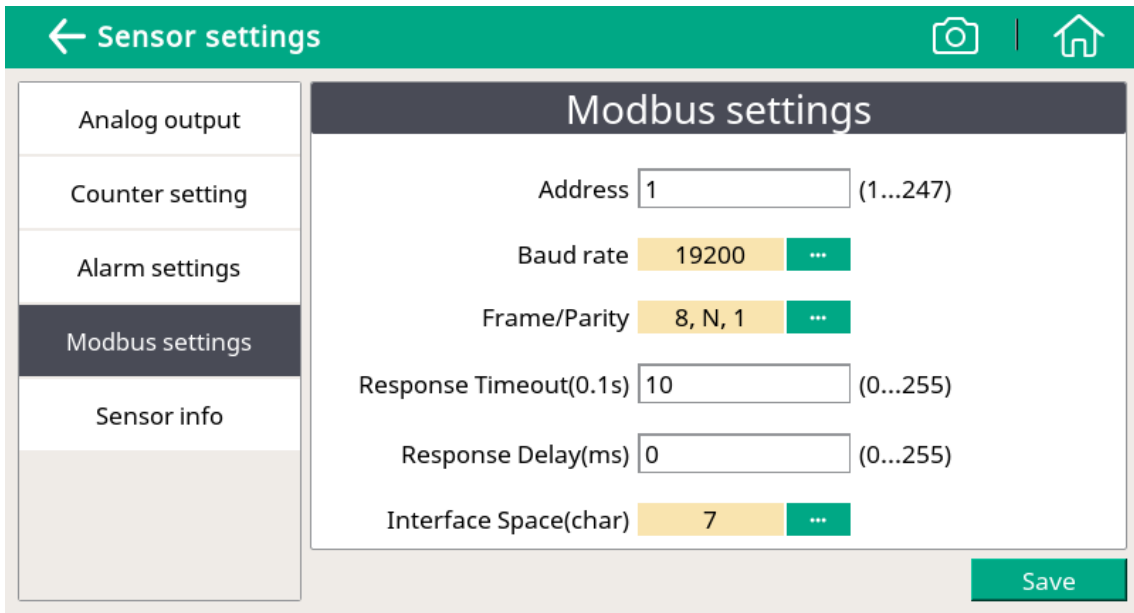

9.5.5 Sensor Info

To view the sensor information including the type, serial number, and firmware version.

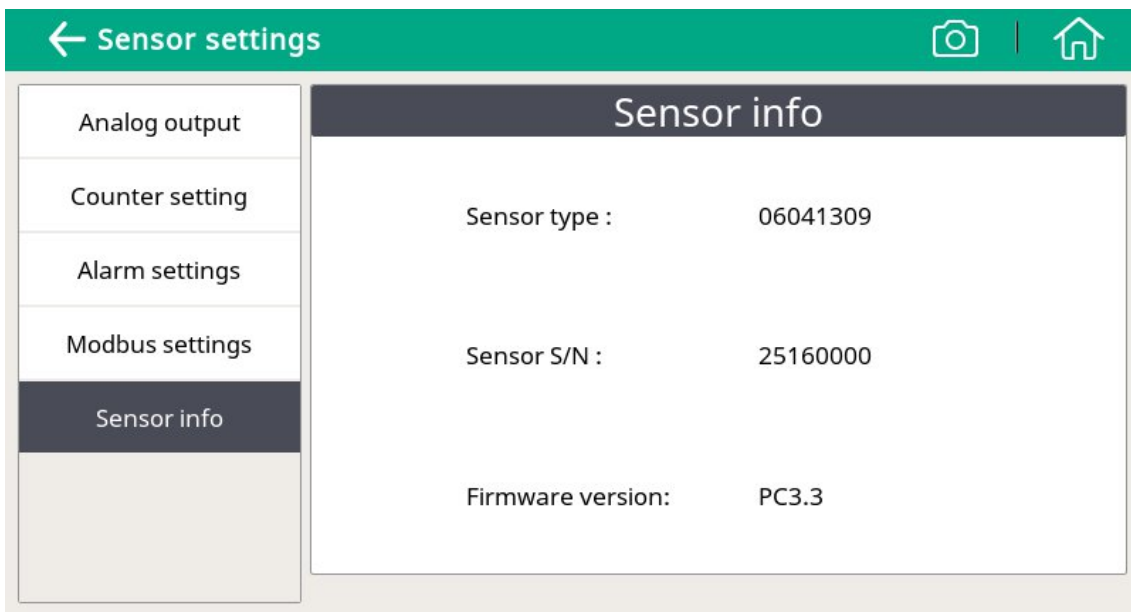

9.6 Guided Measurement with PDF Report Generation

To start the different measurement and monitoring according to your requirement.

The recorded file and report can be viewed after the measurement is done. For more information, see Chapter 10 Guided measurement.

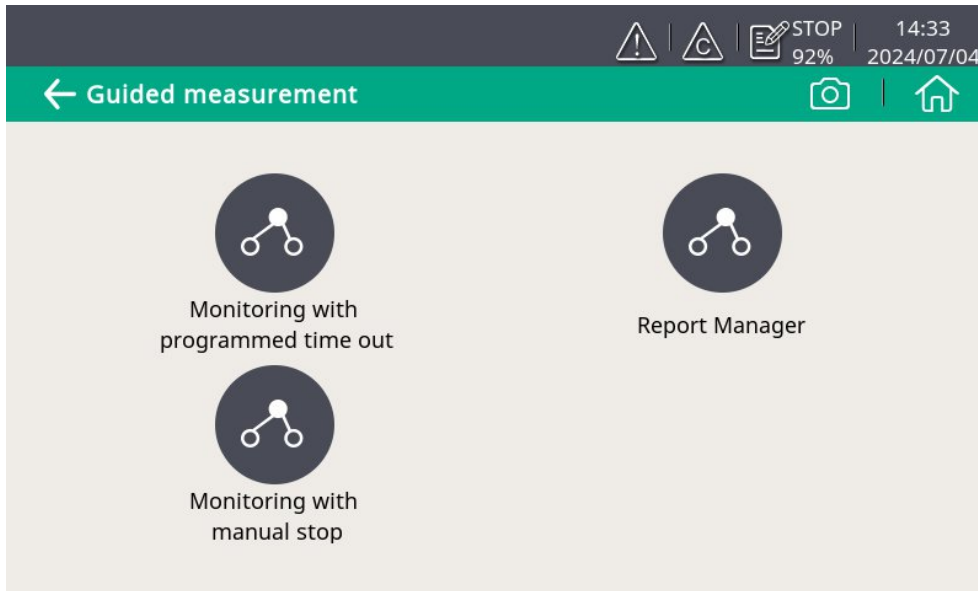

9.7 Service Information

To input the contact information of the company that provides the service. This information is displayed on the PDF report.

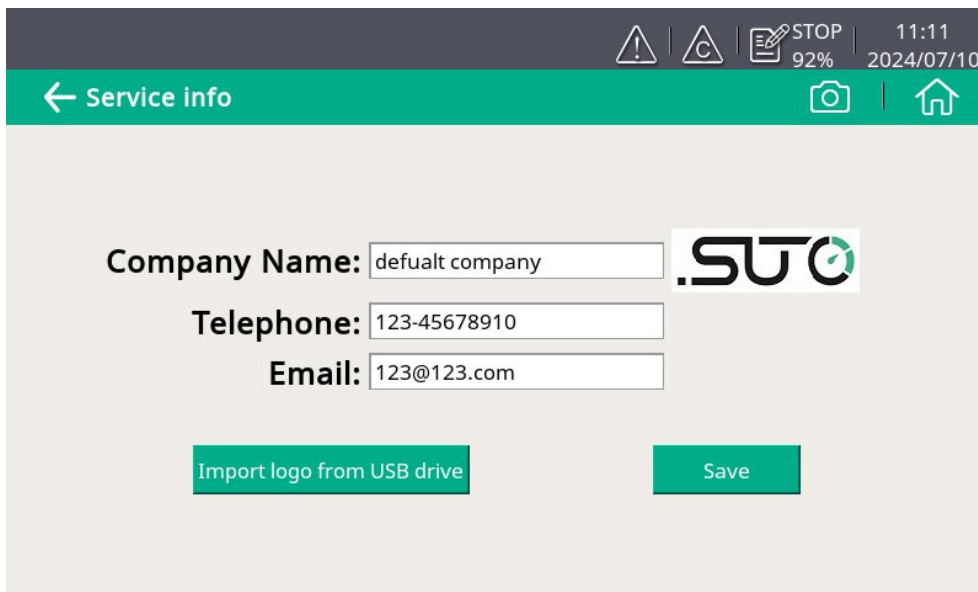

10 Guided measurement

The S132 provides a software-based guided measurement which takes you through the complete measurement. This leads to a simplified measurement process and prevents you from wrong measurements.

To start a guided measurement, do the following:

1. Click **Menu > Guided measurement**.

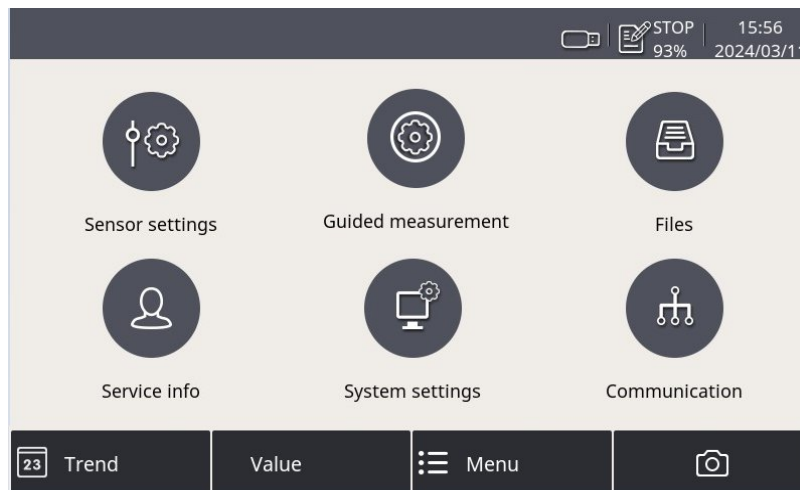

2. Select the type of measurement that you want to perform.

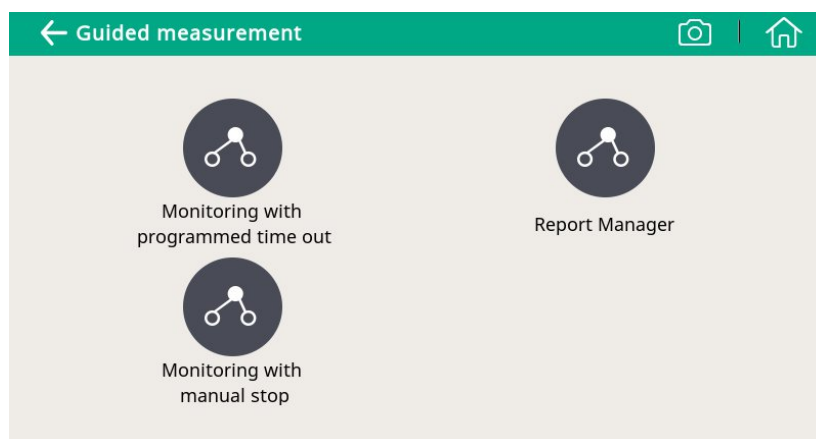

- **Monitoring with programmed time out:** It starts a measurement with a user-programmed period of measurement time. You can set the measurement time during the process of measurement preparation. The system will then, after finishing the programmed measurement duration, stop the measurement automatically and save the data. This mode is ideally used for audits where you must measure at several points. You can

- program for each point a duration of e.g. 2 hours and then you can compare the measurements.
- **Monitoring with manual stop:** It starts the measurement without a programmed stop time. You can click it to start the measurement and stop it whenever you want. Then you can decide if you want to save or delete the data. This can be used to monitor changes in values.
3. Perform the guided measurement following the onscreen instructions. For more information, see section [10.1 Steps for guided measurement](#).
 4. To view and manage the measurement files generated, click **Report Manager**. For more information, see section [10.2 Reports for guided measurements](#).

10.1 Steps for guided measurement

After you start a guided measurement, follow below steps to go through the whole process.

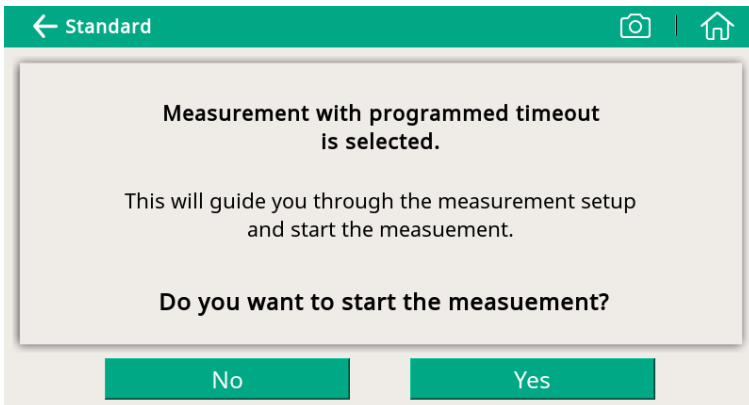

1. An overview is given about the selected measurement types. Click **Yes** to start.

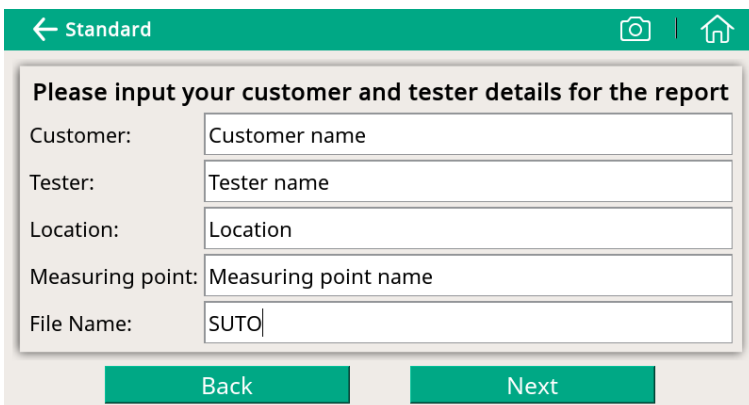

2. Input the customer and tester names, which will be shown on the report.

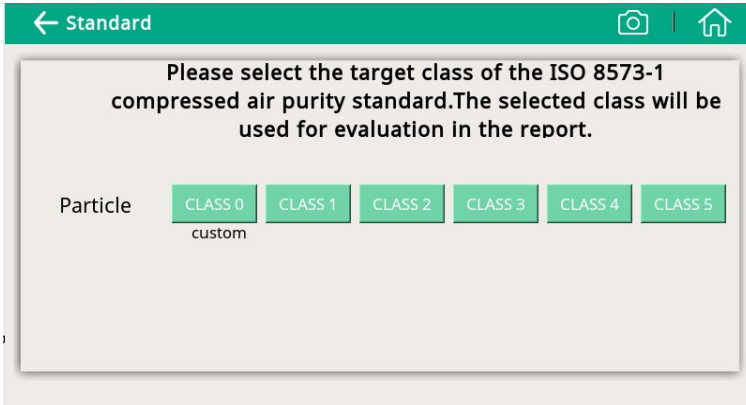

3. Select the compressed air class as needed.
Note: ISO8573 stipulates alarm limit values for different classes. CLASS 0 allows you to customize the alarm limit values.

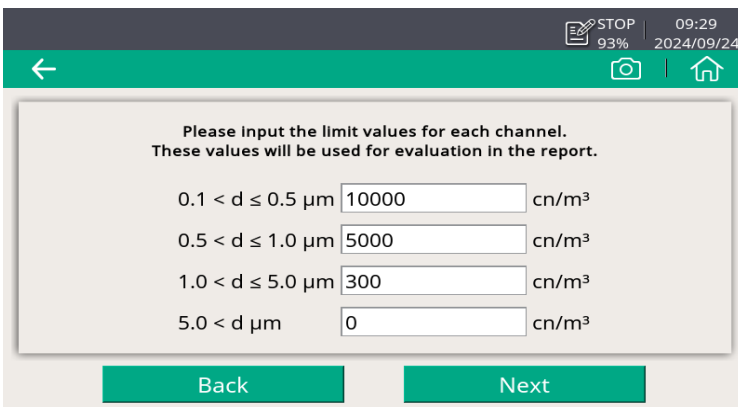

4. Enter a limit value for each measurement channel. (This step is shown only when you selected CLASS 0 in the last step)

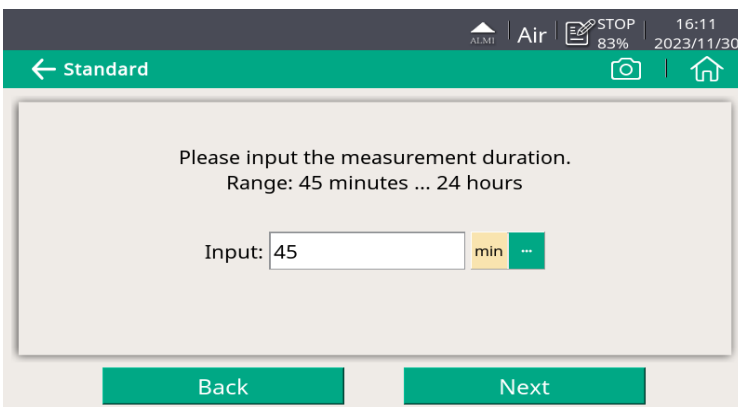

5. Enter the measurement duration. The longer it takes, the more stabilized the values will be and the more exactly it will approximate to the system conditions.

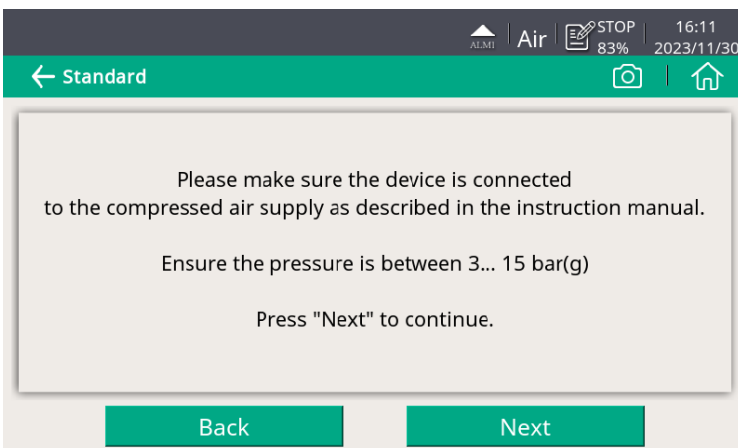

6. The system reminds to connect the compressed gas according to instructions.

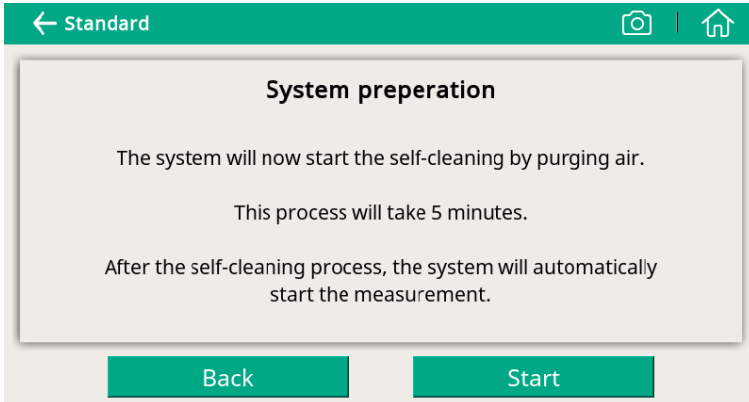

7. System preparation. Click **Start** to start the cleaning and self-calibration.

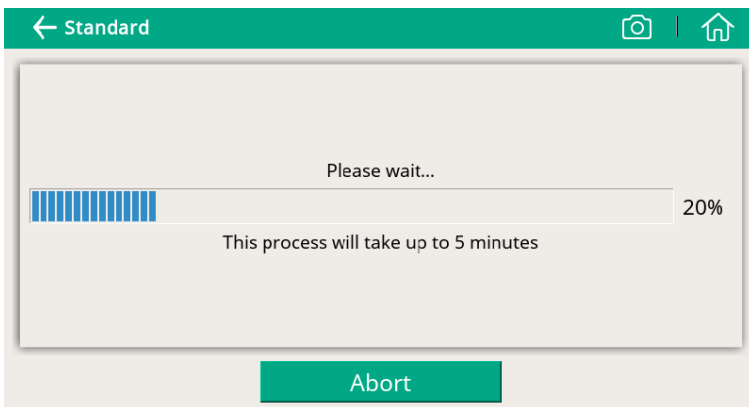

8. The system is performing the self-calibration and cleaning the internal sensor components. After cleaning and calibration, the measurement starts automatically.

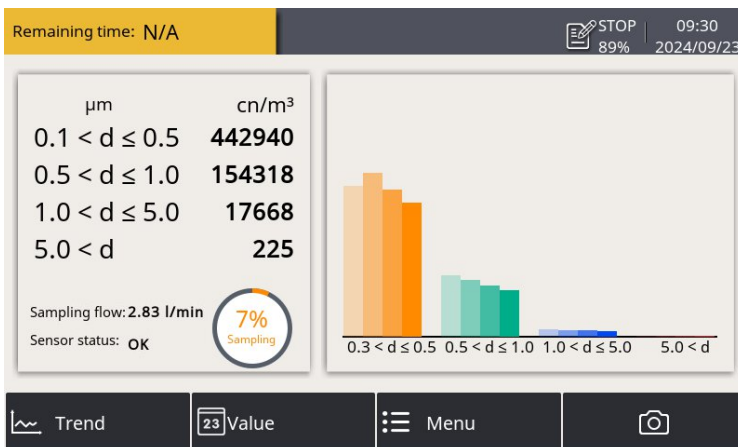

During the measurement, you can see the Data logger status icon on the status bar switched from STOP to LOG. The remaining time is displayed in the upper left corner. Please wait until the system complete the measurement.

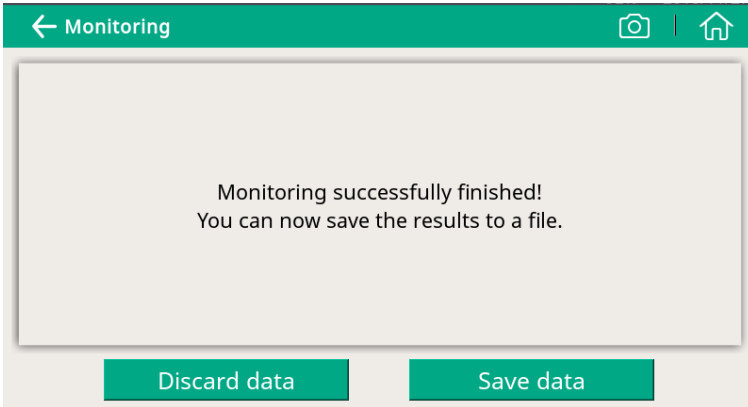

When the measurement is successfully completed, the screen on the left appears. Choose to discard or save the measurement data as needed.

10.2 Reports for guided measurements

After performing guided measurements, you can view and manage measurement files through **Guided Measurement > Report Manager**.

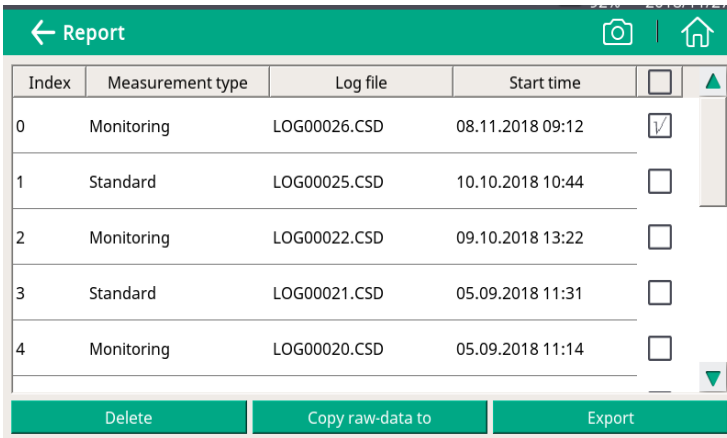

- To view the measurement results, click on the file (not the check box on the right). A window appears showing the PDF for your preview.
- To copy, export or delete files, select the file check boxes, and then click the corresponding button at the bottom.

11 LED indicators at the front panel

- 
- **Power**
 - **Service**
 - **Counting**

- Power LED on—Indicates power supply is connected well.
- Service LED on*—Indicates the device needs to be serviced.
- Counting LED on—Indicates the device is counting particle.

Remark: The Service LED on indicates that the laser is faulty or the sensor is contaminated. In such cases, make sure that you operate in the specified pressure range and purge the sample air through the device for about ten minutes. If the Service LED is still on, contact the customer service.

12 Signal outputs

12.1 Analog output

The S132 has an analog output range of 4 ... 20 mA. This output is scaled as follows:

- 4 mA = 0
- 20 mA = 100000 cn/m^3

12.2 Modbus Interface

The default settings of the Modbus interface are as follows:

Mode	RTU
Baud rate	19200
Device address	Last two digits of the serial number
Framing / parity / stop bit	8, N, 1
Response timeout	1 second
Response delay	0 ms
Inter-frame spacing	7 char

Response message that the device returns to the master:

- Function code: 03

The information of the byte order is shown in the table below:

Byte Order	Sequence				Data Type
	1st	2nd	3rd	4th	
1-0-3-2	Byte 1 (MMMMMMMM*)	Byte 0 (MMMMMMMM *)	Byte 3 (SEEEEEEE)	Byte 2 (EMMMMMMM *)	FLOAT
1-0-3-2	Byte 1	Byte 0 LSB	Byte 3 MSB	Byte 2	UINT32 INT32
1-0	Byte 1 MSB	Byte 0 LSB	---	---	UINT16 INT16
1-0	Byte 1 XXX *	Byte 0 DATA	---	---	UINT8 INT8

* S: Sign, E: Exponent, M: Mantissa, XXX: no value

Explanations of MSB and LSB

- MSB** MSB refers to Most Significant Byte first, which follows the Big-Endian byte order.
For example, if the main system follows the MSB first order:
When the 4-byte floating number, in the order of Byte1-Byte0-Byte3-Byte2, is received from the slave (sensor), the master must change the byte order to Byte3-Byte2-Byte1-Byte0 for the correct display of the value.
- LSB** LSB refers to Least Significant Byte first, which follows the Little-Endian byte order.
For example, if the main system follows the LSB first order:
When the 4-byte floating number, in the order of Byte1-Byte0-Byte3-Byte2, is received from the slave (sensor), the master must change the byte order to Byte0-Byte1-Byte2-Byte3 for the correct display of the value.

Modbus holding register table

Modbus Register Address	Data type	Data length	Channel description	Unit	Res.*	R/W
6	UNIT32	4-Byte	Device status	NA	1	R
8	FLOAT	4-Byte	Channel 1	cn/m ³	1	R
10	FLOAT	4-Byte	Count Channel 2	or mg/m ³	1	R
12	FLOAT	4-Byte	channel Channel 3	or	1	R
14	FLOAT	4-Byte	Channel 4	cn/ft ³	1	R
110	ASCII string**	8-Byte	Unit of counting channel	-	-	R
124	Float	4-Byte	Analog output scaling, 4mA	-	-	R
126	Float	4-Byte	Analog output scaling, 20 mA	-	-	R
128	UNIT16	2-Byte	Analog output routing	-	1	R
130	Float	4-Byte	Alarm threshold ch1	-	1	R
132	Float	4-Byte	Alarm threshold ch2	-	1	R
134	Float	4-Byte	Alarm threshold ch3	-	1	R
136	Float	4-Byte	Alarm threshold ch4	-	1	R
138	UNIT16	4-Byte	Alarm routing	-	1	R

- * The size of channel and the unit of channel is depending on the model (for example, size: "0.1", "0.5"... , unit: "cn/m³", "cn/l"...). If the channel is not available in the model, the string is null. Res. denotes resolution.

Interpretation of system status

The device provides its statuses via Modbus as well. The 32-bit data information is read as single bits. The meanings of these bits are described as follows.

Bit	Description	Bit	Description
0	Laser alert status: 0 = laser is good, 1 = laser alert	3	Instrument service status: 0 = working correctly. 1 = threshold exceeded
1	Flow alert status: 0 = flow rate is good, 1 = flow rate alert	4	Particle threshold exceeded status: 0 = threshold not exceeded, 1 = threshold exceeded
2	Particle overflow status: 0 = no overflow, 1 = instrument malfunction detected	5	Alarm status 0 = normal, 1 alarm triggered

12.3 Alarm output

The sensor has a relay output with a NO, 40 VDC, 0.2 A rating. It is possible to monitor, for example the particle content and give an alarm at a particular value.

Alarm relay specifications:

Rating: 40 VDC, 0.2 A
 Power off state: NO (normally open)
 Default threshold value: 500000 cn/m³

Please find the different states in the following table below.

Situation	Relay state
S132 is powered off	OPEN
S132 is powered on / The alarm value is not reached	CLOSED
S132 is powered on / The alarm value is reached	OPEN

The advantage of the normally open relay is, that both critical situations

can be detected, not only if the alarm value is reached, also if the device has any power loss.

To trigger an external buzzer or alarm light, you need to invert the signal and build an external alarm circuit. The following figure shows an example.

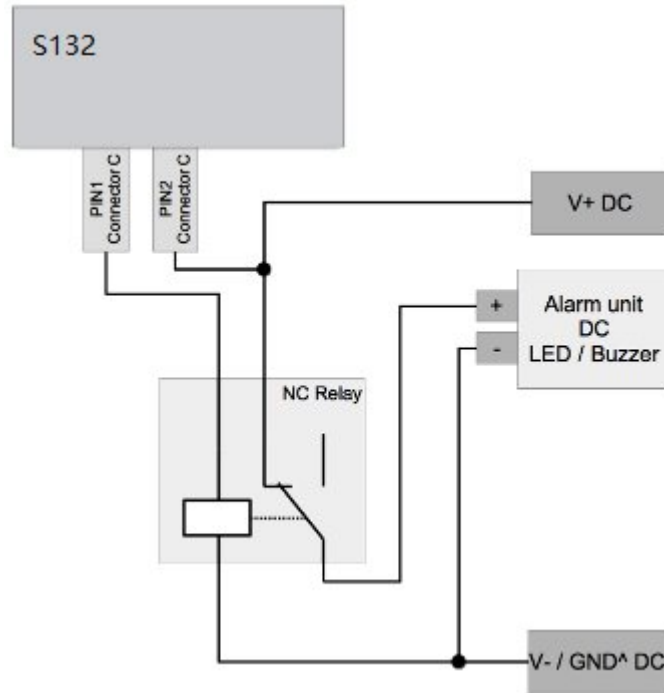

13 Optional accessories

Service kit is an optional tool that enables you to manage and monitor SUTO devices on a computer.

The following figure shows the connection of the service kit, S132, and the computer. Please ensure that either the S132 or the service kit is connected with the power supply because the USB port cannot supply enough power to both these two devices.

Please see the instruction manual of the service kit for more details.

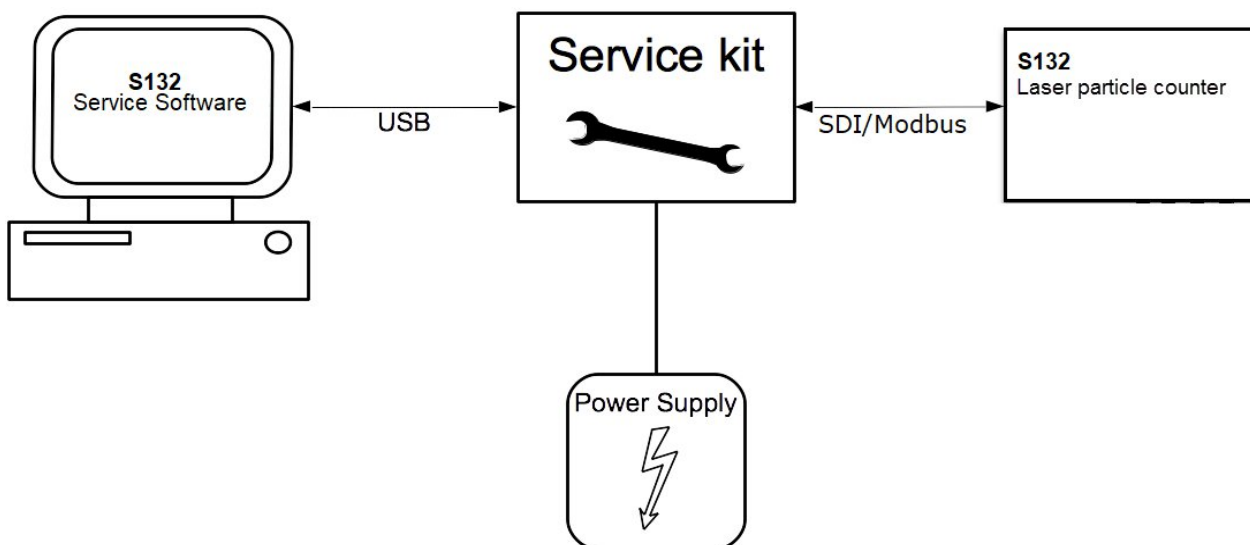

14 Calibration

The sensor is calibrated before delivery. The exact calibration date is printed on the certificate which is supplied together with the sensor. The accuracy of the sensor is regulated by the on-site conditions, and parameters such as oil, high humidity or other impurities can affect the calibration and furthermore the accuracy. However it is recommended you calibrate the instrument at least once per year. The calibration is excluded from the instruments warranty. To inquiry with the calibration service, please contact the manufacturer.



ATTENTION!

Please save all your measurement data on an external device before returning the instrument to calibration and service. It might be necessary to reset the displays storage during calibration and service.

15 Maintenance

To clean the device and its accessories, it is recommended to use moist cloth only.



ATTENTION!

Do not use isopropyl alcohol to clean the display!

16 Disposal or waste



Electronic devices are recyclable material and do not belong in the household waste.

The sensor, the accessories and its packings must be disposed according to your local statutory requirements.

The dispose can also be carried by the manufacturer of the product, for this please contact the manufacturer.

SUTO iTEC GmbH

Grißheimer Weg 21
D-79423 Heitersheim
Germany

Tel: +49 (0) 7634 50488 00
Email: sales@suto-itec.com
Website: www.suto-itec.com

SUTO iTEC (ASIA) Co., Ltd.

Room 10, 6/F, Block B, Cambridge Plaza
188 San Wan Road, Sheung Shui, N.T.
Hong Kong

Tel: +852 2328 9782
Email: sales.asia@suto-itec.com
Website: www.suto-itec.com

SUTO iTEC Inc.

5460 33rd St SE
Grand Rapids, MI 49512
USA

Tel: +1 (616) 800-7886
Email: sales.us@suto-itec.com
Website: www.suto-itec.com

All rights reserved ©

Modifications and errors reserved

S132_IM_EN_V2025-2