

Instruction and Operation Manual

S531

Smart Ultrasonic Leak Detector



Dear Customer,

Thank you for choosing our product.

Before you start up the device, please read this manual in full and carefully observe instructions stated. The manufacturer cannot be held liable for any damage that occurs because of non-observance or non-compliance with this manual.

Should the device be tampered with in any manner other than a procedure that is described and specified in the manual, the warranty is void and the manufacturer is exempt from liability.

The device is designed exclusively for the described application.

SUTO offers no guarantee of the suitability for any other purpose. SUTO is also not liable for consequential damage resulting from the delivery, capability or use of this device.

Revision: 2025-1



Last modifications: February, 2025

Table of Contents

1	Safety instructions	5
2	Registered trademarks.....	7
3	RF Exposure Information and Statement.....	8
4	Application.....	9
5	Features.....	9
6	Technical data.....	10
6.1	General data	10
6.2	Electrical data.....	10
6.3	Performance data.....	11
7	Scope of delivery.....	12
8	Learning about the device.....	13
8.1	Components.....	13
8.2	Touch screen display.....	14
8.3	Dimension and electrical ports.....	16
9	Before you start for the first time.....	17
9.1	Charging the device.....	17
9.2	Performing initial setup.....	17
10	Procedures of detecting leakages	19
10.1	Create a project	20
10.2	Specify the measurement settings.....	20
10.3	Search and locate a leakage.....	21
10.4	Record the leak.....	22
10.5	Manage leak record and projects.....	24
10.5.1	Edit or delete a leak record.....	24
10.5.2	Edit or delete a project.....	26
10.6	Export project files	27
10.6.1	Export to a USB drive.....	28
10.6.2	Copy from S531 to PC	28
10.7	Import project files to LMS.....	28
11	Maintenance.....	29
11.1	Self-test.....	29
11.2	Update the firmware.....	29
11.3	Reset the device.....	32
11.4	Clean the sensor.....	32
12	Optional accessories.....	33
13	Disposal or waste.....	34
14	Appendix: Headset Usage.....	35
14.1	Power on or off.....	36
14.2	Turn on or off Noise Cancellation.....	36
14.3	Use headset in the wireless mode.....	37

14.4 Use headset in the wired mode.....37
14.5 Pairing a new headset with the S531.....38
14.6 Care and maintenance.....39

1 Safety instructions

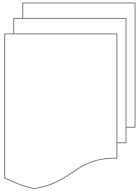

Please check if this instruction manual matches the product type.

Please observe all notes and instructions indicated in this manual. It contains essential information which must be observed before and during installation, operation and maintenance. Therefore, this instruction manual must be read carefully by the technician as well as by the responsible user or qualified personnel.

This instruction manual must be available at the operation site of the leak detector at any time. In case of any obscurities or questions, regarding this manual or the product, please contact the manufacturer.

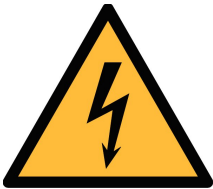

WARNING!

Compressed air!

Any contact with quickly escaping air or bursting parts of the compressed air system can lead to serious injuries or even death!

- Avoid that persons get hit by escaping air or bursting parts of the system.



WARNING!

Laser pointer!

Do not point into the eyes with the laser. It can lead to serious injuries particularly on lens and retina or even blindness!

- Never look directly at the laser.
- Never point the laser at people.
- Never point the laser at smooth and reflective surfaces. This can lead to a reflection of the laser.



WARNING!

Voltage used for supply!

Any contact with energized parts of the product, may lead to an electrical shock which can lead to serious injuries or even death!

**WARNING!**

To prevent possible hearing damage, do not listen at high volume levels for long periods.

**ATTENTION!****Permitted operating parameters!**

Observe the permitted operating parameters, any operation exceeding these parameters can lead to malfunctions and may lead to damage on the instrument.

- Do not exceed the permitted operating parameters.
- Make sure the product is operated to its permitted limitations.
- Do not exceed or undercut the permitted storage and operation temperature and pressure.

General safety instructions

- It is not allowed to use the product in explosive areas.
- Please observe the national regulations before/during operation.

Remarks

- It is not allowed to disassemble the product.

**ATTENTION!****Measurement values can be affected by malfunction!**

The device must be used properly and frequently maintained, otherwise it may lead to wrong measurement values that can lead to wrong results.

- Avoid condensation on the leak detector sensor because this will affect the accuracy enormously.

Storage and transportation

- Ensure the transportation temperature is between -20 ... +50°C.
- For transportation it is recommended to use the packaging that comes with the leak detector.
- Please ensure that the storage temperature of the sensor is between -10 ... +50°C.
- Avoid direct UV and solar radiation during storage.
- For the storage the humidity must be <90%, no condensation.

2 Registered trademarks

Trademark	Trademark owner
------------------	------------------------

SUTO®	SUTO iTEC
-------	-----------

MODBUS®	Modbus Organization, Hopkinton, USA
---------	-------------------------------------

HART®	HART Communication Foundation, Austin, USA
-------	--

3 RF Exposure Information and Statement

This equipment complies with FCC RF radiation exposure limits set forth for an uncontrolled environment. This equipment should be installed and operated with a minimum distance of 20 cm between the radiator and your body.

This device complies with part 15 of the FCC rules. Operation is subject to the following two conditions: (1) this device may not cause harmful interference, and (2) this device must accept any interference received, including interference that may cause undesired operation.

NOTE: The manufacturer is not responsible for any radio or TV interference caused by unauthorized modifications to this equipment. Such modifications could avoid the user's authority to operate the equipment.

NOTE: This equipment has been tested and found to comply with the limits for a Class B digital device, pursuant to part 15 of the FCC Rules. These limits are designed to provide reasonable protection against harmful interference in a residential installation. This equipment generates uses and can radiate radio frequency energy and, if not installed and used in accordance with the instructions, may cause harmful interference to radio communications. However, there is no guarantee that interference will not occur in a particular installation. If this equipment does cause harmful interference to radio or television reception, which can be determined by turning the equipment off and on, the user is encouraged to try to correct the interference by one or more of the following measures:

- Reorient or relocate the receiving antenna.
- Increase the separation between the equipment and receiver.
- Connect the equipment into an outlet on a circuit different from that to which the receiver is connected.
- Consult the dealer or an experienced radio/TV technician for help
- This device and its antenna(s) must not be co-located or operating in conjunction with any other antenna or transmitter.

4 Application

The S531 is a Smart Ultrasonic Leak Detector that helps you quickly detect and provides quantitative data for the leakages in compressed air or any pressurized gas systems.

Gas leaks emit ultrasound; however the frequency is too high to hear by human ear directly. The S531 converts the leak ultrasound to a lower frequency that can be heard through headphones from several meters away, which leads you to find the leak source.

In unpressurised systems, you can use an ultrasonic tone generator to generate sounds that can be detected by the S531.

To efficiently manage the leak data, SUTO offers the Leak Management Software (LMS) for your need. The LMS provides a total solution for leak detection, management and easy report creation.

This manual takes you through how to use the S531.

5 Features

- Detects leaks in the compressed air or gas system easily even from a distance.
- Supports high resolution 3.5" color touch screen, easing operations in leak detection.
- Supports wireless connection with headset.
- Builds in camera to take photo of leak locations.
- Provides voice recorder for voice memos.
- Equipped with laser pointer to pinpoint leak locations.
- Records leak information for statistics and repair.
- Calculates air loss in l/min, m³/h or cfm and in the local currency
- Integrates noise reduction technology.
- Supports battery capacity for up to 6 hours.

6 Technical data

6.1 General data

  	Contains FCC ID: 2ADHKWINC3400
---	--------------------------------

Principle of measurement	Ultrasonic leak detection
Measuring medium	Compressed Air, refrigerants and any compressed gases
Jack	3.5 mm stereo phone jack for headset
Operating temperature	0 ... +40°C
Operating frequency	40 kHz ± 2 kHz
Materials of detector	PC + ABS
Dimensions	See section 8.3 .
Interface	Wireless connection to headset USB port for charging and data exchange
Display	3.5" color LCD
Laser pointer	Wavelength: 640 ... 660 nm Output power: < 1.0 mW
Camera	5.0 megapixels
Headset	Noise cancellation and wireless
Transportation case size	425 * 325 * 130 mm
Weight	3.65 kg (full set)

6.2 Electrical data

Power supply	Internal lithium-ion rechargeable battery, 3.7 VDC, 3500 mAh Battery life: About 6 hours Charging temperature: +10°C ... +45°C Charging time: About 3 hours
--------------	---

6.3 Performance data

The table shows the detection distance of various hole diameters at different pressures in the lab environment and with the trumpet on.

Diameter Pressure	0.1 mm	0.2 mm	0.5 mm
0.5 bar	0.5 m	1.7 m	7 m
5.0 bar	3.6 m	11.5 m	18 m

7 Scope of delivery

The S531 layout in the transportation case is shown below.



Please make sure that components below are included in your package.

Qty	Description	Item No.
1	S531 Smart Ultrasonic Leak Detector	P560 0104
1	Noise isolated/canceling wireless headset (page 35)	A554 0119
1	Focus tube and focus tip (used for leak detection)	A530 0101
1	Trumpet (used to increase sensitivity and isolate from environmental noise)	A554 0123
1	Battery charger	A554 0117
1	Type-C USB stick	A554 0124
1	Transport case	A554 0118
1	Leak tags to mark found leaks, 100 pieces	A554 0122
1	Instruction manual	NA
1	Calibration certificate	NA
Optional accessories:		
1	Ultrasonic transmitter	A554 0133
1	Calibration for S531	R200 0070

8 Learning about the device

This chapter describes components of the S531 main unit.

8.1 Components



Part	Description
1	Power button: Long press for 2 seconds to turn S531 on or off. It also works as a shortcut button for taking photos in leak detection.
2	Voice recording button: Click to start recording voice memos, then click to stop recording during leak detection.
3	Laser button: Press to turn the laser on or off.
4	Sensitivity wheel: Turn the wheel to fine tune the sensitivity setting. Turn the wheel up to increase the sensitivity and down to decrease the sensitivity. Turning the sensitivity up or down makes the volume go up or down. Note: The sensitivity setting does not impact the sound level reading.
5	Touch screen: for further functions
6	Sensor unit: To detect the ultrasound level.
7	Microphone: Used for recording voice memo.

8.2 Touch screen display

The 3.5" touch screen enables you to record and manage leak records and change the S531 settings.

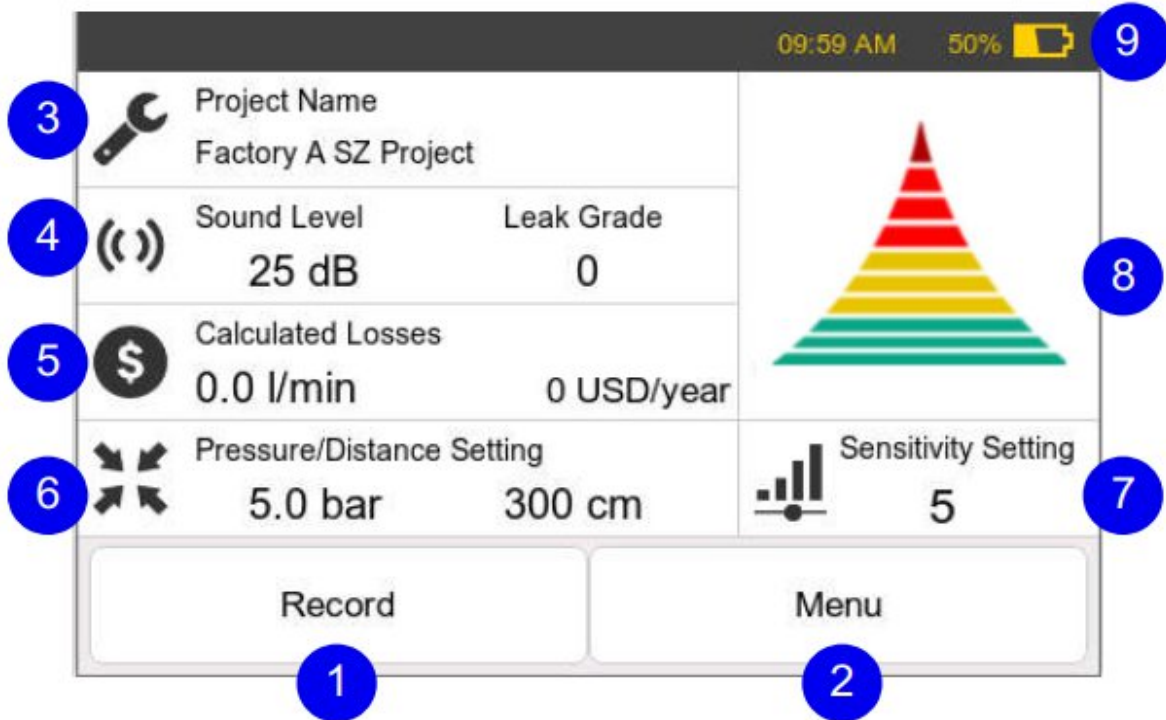

UI part	Description
1	Record button Detects and records a detected leakage by recording voice memos and taking photos.
2	Menu button Performs additional actions. For more details, please see the following chapters.
3	Project Name Shows the name of the project. Switch to another project by touching it and select from the project list.
4	Sound Level Shows the sound intensity in dB. Range: 0 ... 99 dB. Leak Grade Shows the grade of the detected leakage: <ul style="list-style-type: none"> Grade 0: Leakage = 0 l/min Grade 1: 0 < Leakage ≤ 1 l/min Grade 2: 1 < Leakage ≤ 4 l/min

- Grade 3: $4 < \text{Leakage} \leq 9$ l/min
- Grade 4: Leakage > 9 l/min

5 Calculated Losses

Shows the detected leakage and the loss amount of cash per year.
Leak losses are calculated based on the sound level detected as well as the pressure and distance settings.

6 Pressure / Distance Setting

Shows the latest settings for the pressure in the detected object and the distance between the S531 sensor and the leak point.
You can change the settings by touching the numbers on the touch screen.

7 Sensitivity Setting

Shows the sensitivity level (from 0 to 7) to the ultrasound. The higher the number is, the louder the volume you can hear.
By turning the sensitivity wheel, you can adjust the sensitivity level to change the volume.

8 Sound level bar

Indicates the intensity of the sound that the S531 detects: Red strongest, yellow the less, and green the least.
You can see the actual sound level in dB in the **Sound Level** area.

9 Status bar

Shows the S531 status, including the following icons or text:

Type	Icon/Text	Description
Icon	Trumpet	Indicates that the trumpet is mounted on and well connected with the sensor.
Icon	Battery	Indicates the percentage of battery capacity.
Icon	Laser	Indicates that the laser pointer is turned on.
Icon	Type-C USB stick	Indicates that a USB drive is inserted.

8.3 Dimension and electrical ports

See the following figure for dimensions of the S531 main unit. The unit comes with two electrical connectors:

- USB Type-C port: On the right-hand side of the S531 in the front view, used to charge the S531 and transfer data.
- Headset jack, At the bottom of the S531 handle, reserved to connect the wireless headset through the supplied audio cable when the headset runs out of power.

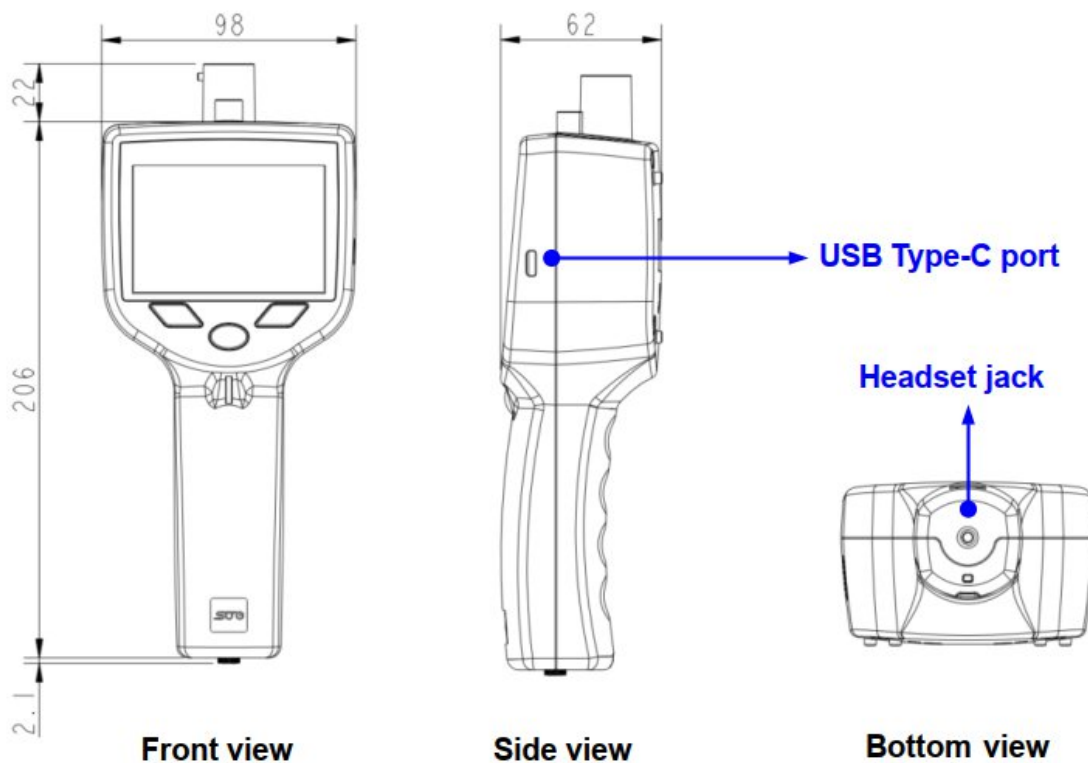

9 Before you start for the first time

Before you use the new S531 to detect leaks for the first time, charge the device and perform the initial device setup.

9.1 Charging the device

The S531 is a battery-powered device and partially charged before delivery. If the battery power is low, charge it via the USB Type-C port on the right-hand side of the device. Please use the USB cable and one of four charging adapters supplied in the delivery package to charge.

9.2 Performing initial setup



1. Turn on the S531 by pressing the Power button for a few moments.

The S531 starts up. When the process is completed the home screen shown on the left appears.

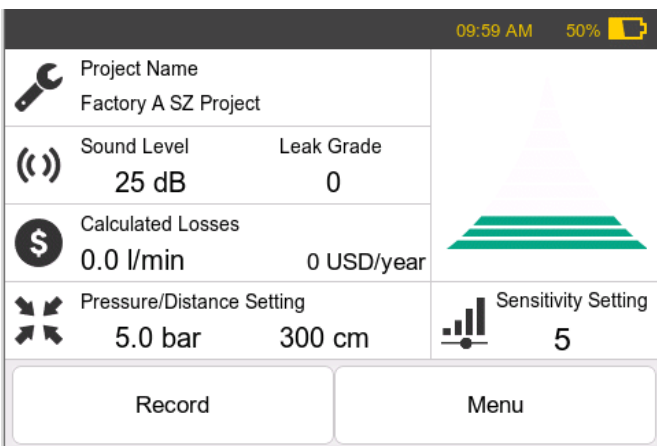

2. Access **Menu > Device Settings**

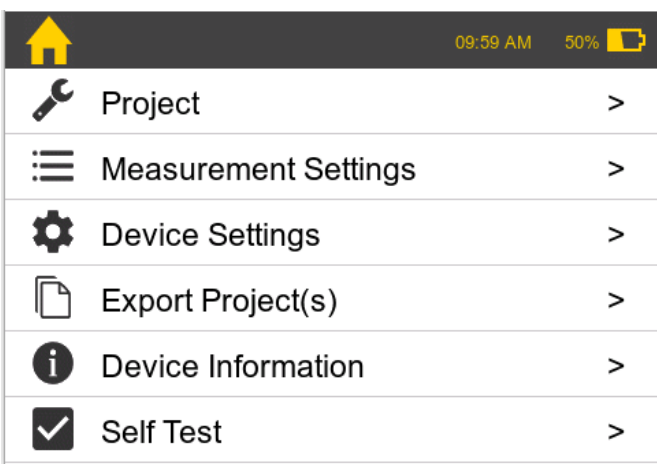

3. Click **Date/Time** to specify the date, time, and time zone.

Note: Wrong settings will lead to wrong date and time in all reports, which cannot be corrected in the LMS.

4. Click **Language** to specify the device language.

5. When using the headset to hear leaked sounds, a wired or wireless connection must be established between the headset and the S531. For detailed operations, see [Appendix: Headset Usage](#).



ATTENTION!

After using the wireless headset, remember to turn it off. Otherwise the headset is in power-on status until the power runs out.

6. Click **Volume Control** to adjust the volume of the speaker and headset.

Note: The device cannot play the audio recordings through the wireless headset. You can play the recording on the speaker or connect it to a wired earphone.

7. To select the metric unit or imperial unit, click **Unit Setting**. This will be the default setting for all projects. While defining each project, you can set specific units for that project.

8. To adjust the display brightness, click **Display Settings**.

9. To adjust the volume of pressing buttons, click **Beeper Settings**.

10. Click **Memory Info** to view the memory information of the device. The **Firmware Update** and **System Reset** are for maintenance, see Maintenance section.

Note: By clicking the  icon on the top left side, you can return to the home screen.

10 Procedures of detecting leakages

Leak detection is managed by the “Project” in the S531. By defining a project, the leak data are recorded. Multiple projects can be created in one S531.

The procedure for detecting leaks is shown in the figure below.

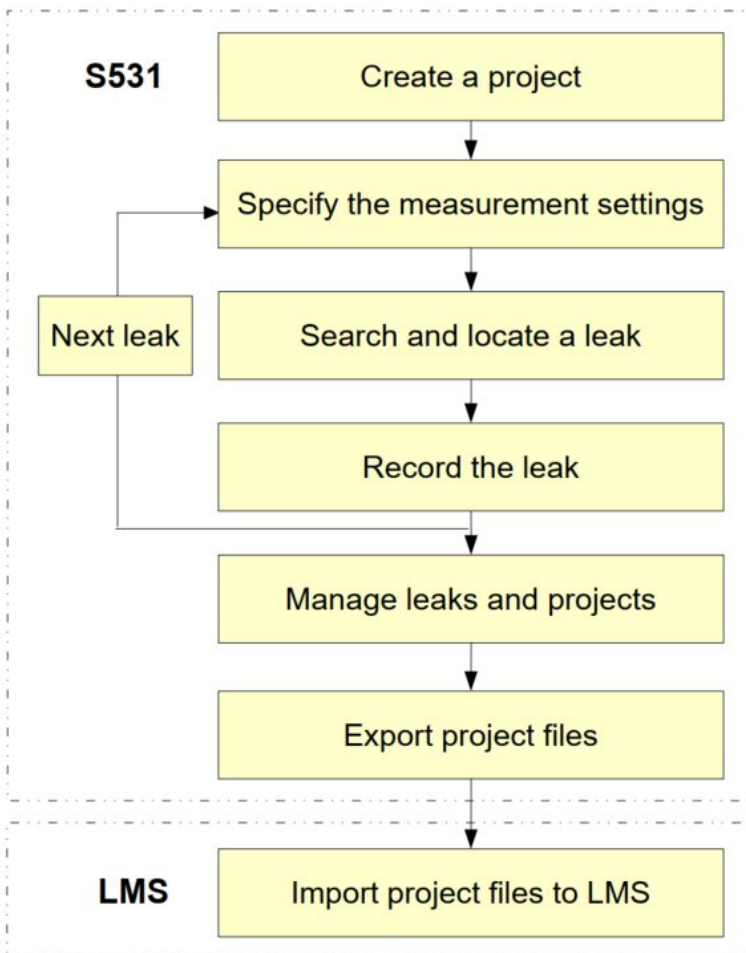

1. [Create a project](#)
2. [Specify the measurement settings](#)
3. [Search and locate a leakage](#)
4. [Record the leak](#)
5. [Manage leak record and projects](#)
6. [Export project files](#)
7. [Import project files to LMS](#)

10.1 Create a project

Follow the steps below to create a project:

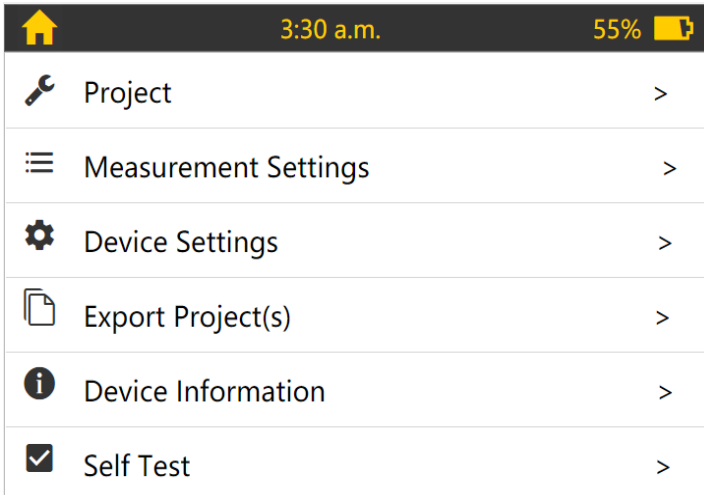

1. Click **Menu > Project > Create Project.**

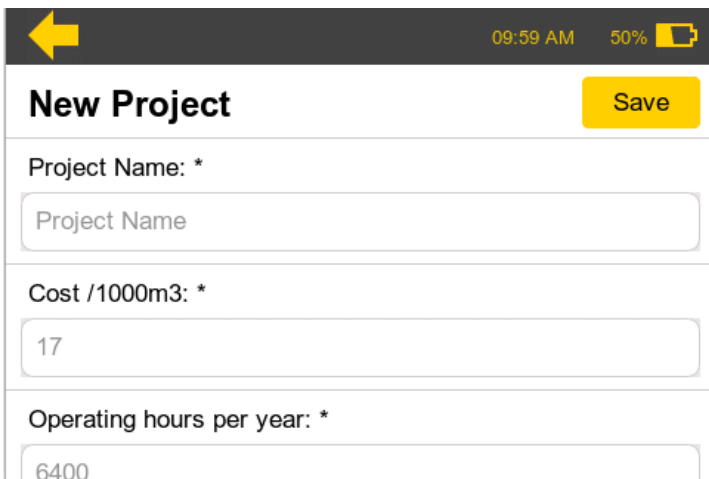

2. Input **Project Name, Cost, Currency, Operating hours/year.**

Click **Edit** to select flow unit and pressure unit. Add some description in **Note** field (optional).

3. Click **Save** to save the project.

10.2 Specify the measurement settings

1. Click **Menu > Measurement Settings** to select the following:

- Pressure Setting: select the actual pressure of the gas in the pipe.
- Distance Setting: select the distance that you will detect the leakage.

2. Click  to save the settings.

10.3 Search and locate a leakage



1. Go back to the home screen.



2. Mount the trumpet on the sensor.

3. Find the leak point by following the steps below.

a. Put on headset.

The noise sounds like "beep, beep". The leak sound from the headset sounds like hissing sound.

b. Trace the sound to find the source.

Note: The sensitivity does not affect the measurement value of the leak.



4. (Optional) If the leak point is not able to be found by using the trumpet, pinpoint the exact leak location using focus tube.

When you are close to the leak point, mount the focus tube and focus tip onto the sensor, and scan with the focus tip until the exact location is found.

Note: The focus tube and tip are used to pinpoint the leak area. Do not use them in measuring flow leak.



5. (Optional) Use the laser pointer to point at the leak location.

- a. Press the laser button to turn on the laser.
- b. Point at a suspected leak with the laser.

Note: To avoid laser injury, the laser function is enabled only when the home screen is displayed. If you enter other screens, the laser function is disabled.

10.4 Record the leak

After you identify the exact position of a leak point, you can start to record the leak data.



ATTENTION!

The calculation of leak losses depends on many factors, such as pressure, distance, background noise, size and shape of the leakage gap, and so on.

To get accurate results, recommend you to do follows:

- **Detect leaks with the trumpet mounted on the S531.**
- **Search for the maximum sound level and then trigger the leak recording.**
- **You can detect leaks from a distance, but keep in mind that recording loss estimation is best performed at a close distance. Recommend you to record leaks at a fixed distance of 1 meter.**

Note: Most actual single leaks in a typical factory are less than 60 l/min. It is unlikely for a leak over 60 l/min to occur in a factory environment. Therefore, the SUTO laboratory focuses on detecting leaks that are less than 60 l/min. Leaks with a rate of 60 l/min or more can be easily detected by normal hearing. A leak detector is not necessary for these types of leaks. The leak detector is intended to find leaks that are not easily detectable by human ears.

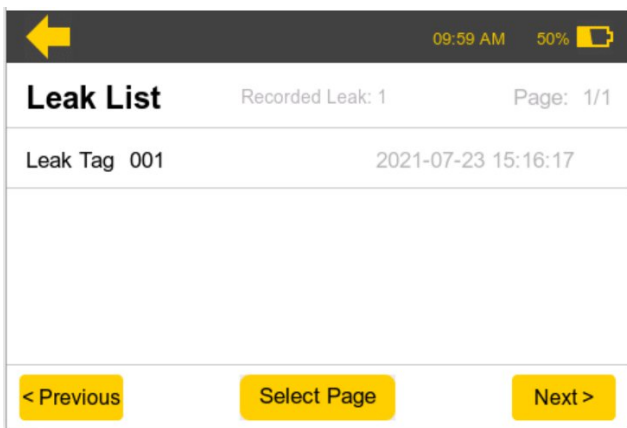
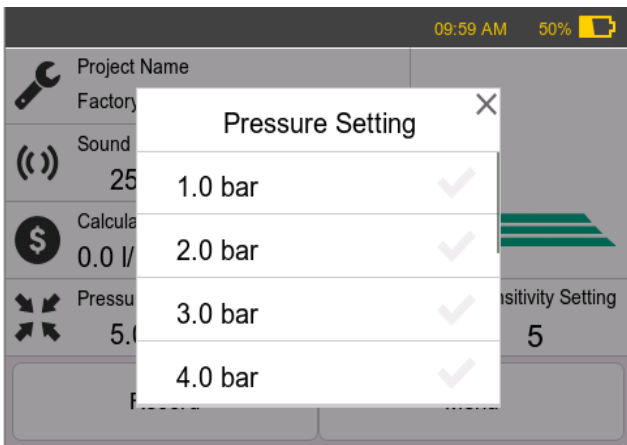

1. Adjust the pressure and distance.
Press the pressure value and distance value to adjust the pressure and distance. Ensure that the pressure value and distance are consistent with the actual condition.

2. Start to record by pressing the **Record**.

3. Create a leak record as follows.

- Input the location where the leak occurs in **Location** field.
- Input the group that the leak belongs to in the **Group** field.

The group can be the name of production line or component of compression system, such as compressor, pipeline, and filter. The group will ease you to manage the leak records in the LMS.

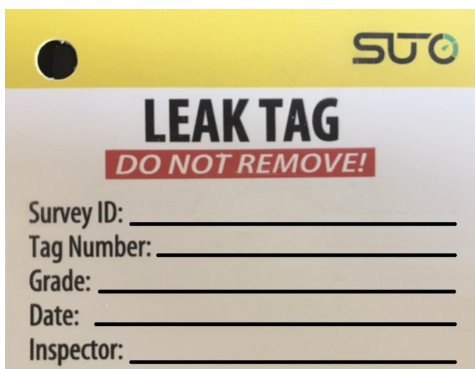

4. Write down the leak information on the paper of LEAK TAG.

Note: Fill the project name to the **Survey ID** field.

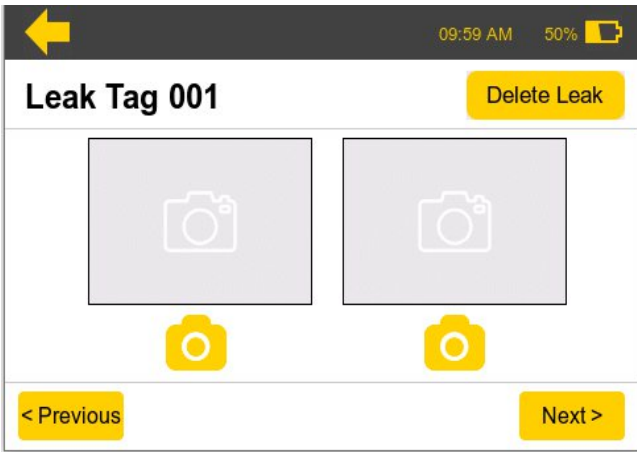

5. Take photos of the detected leak point.

- Press **Next** to enter the photograph page.
- Press the camera icon to take a photo.

Note: Up to 2 photos can be taken. It is recommended that the one is an overall view, and the other is a closeup.

6. Hang the tag near the leak point.

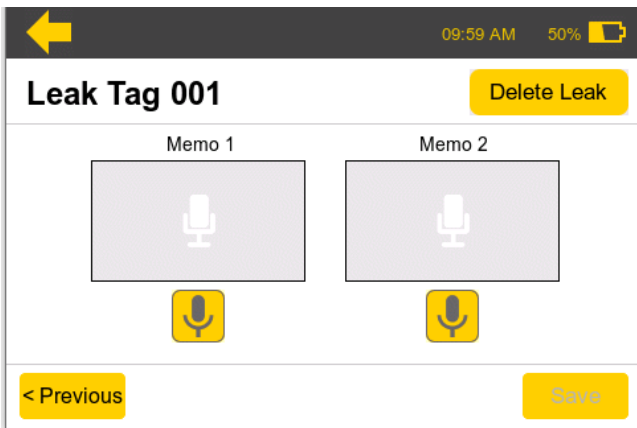

7. Record the situation by sound recording.

- Press **Next** to enter the recording page.
- Press the microphone icon to record.

Note: Up to 2 audio recordings are supported.

8. Save the leak record by pressing the **Save** icon.

10.5 Manage leak record and projects

10.5.1 Edit or delete a leak record

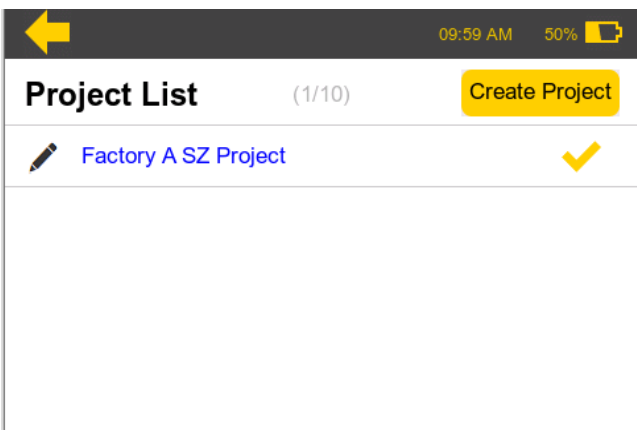

1. Access **Menu > Project** to enter **Project List** page.

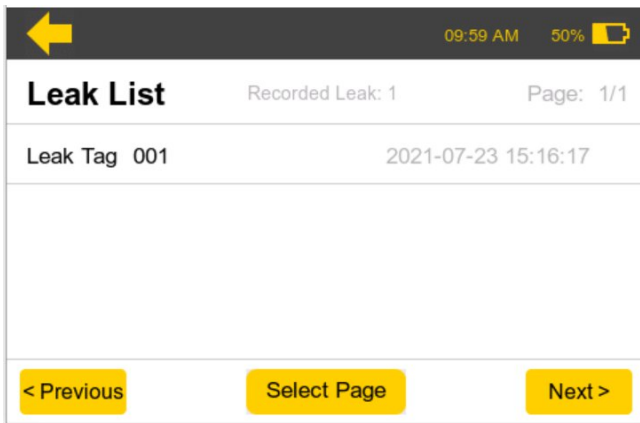

2. Click the project name in which the leak record to be edited is contained.

Note: One page only displays 4 records. Press **Previous** or **Next** to view the previous 4 records or the next 4 records. To view the other records, press **Select Page** to select the desired page.

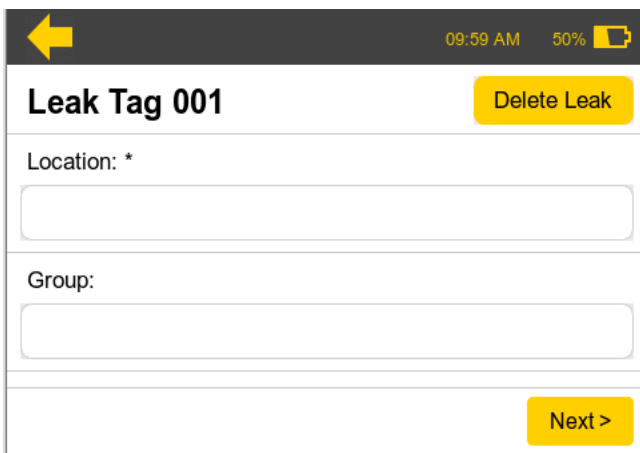

3. Press the specific **Leak Tag** to enter the edit page. In this page you can edit the information in the **Location**, **Group**, and **Notes** fields.

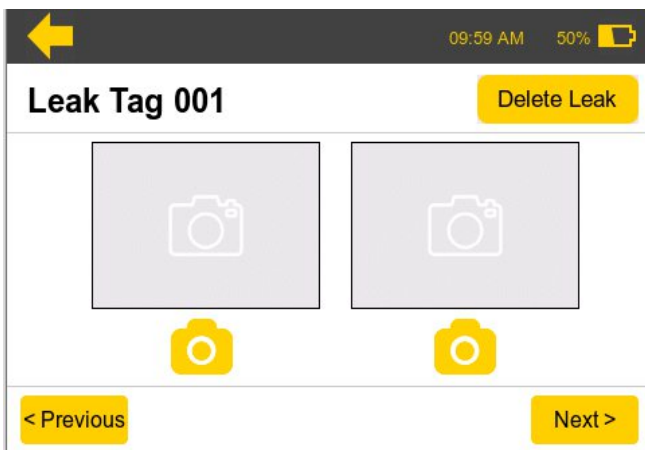

4. Click **Next** to enter the picture page. In this page, you can remove the pictures and take new ones.



5. Click **Next** to enter the voice memo page. In this page, you can remove the voice records and take new ones.

6. Click **Delete Leak** to delete the current leak record.



ATTENTION!

After the photo, voice memos, and records are deleted, they cannot be retrieved.

10.5.2 Edit or delete a project

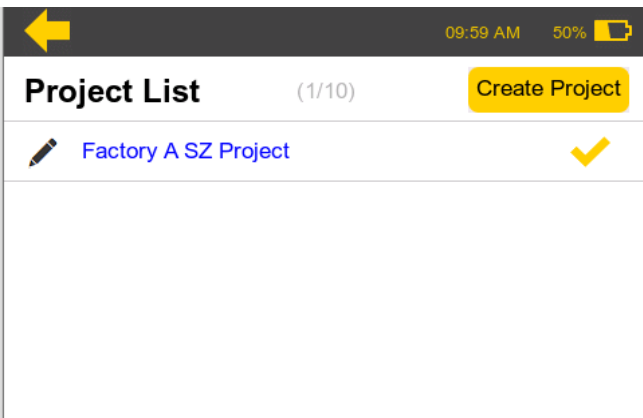

1. Access **Menu > Project** to enter the **Project List** page.

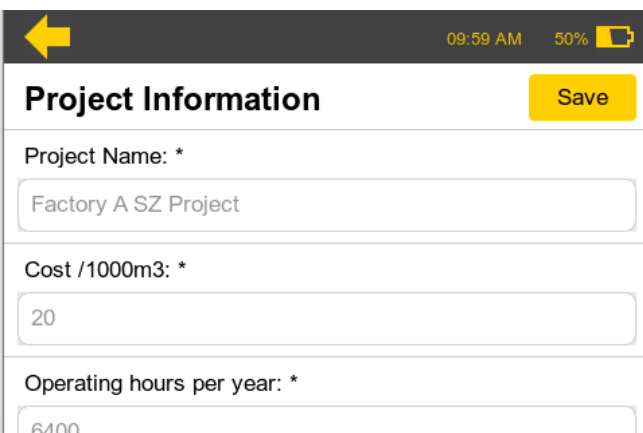

2. Click  to enter the project edit page. In this page, you can edit project information and save.

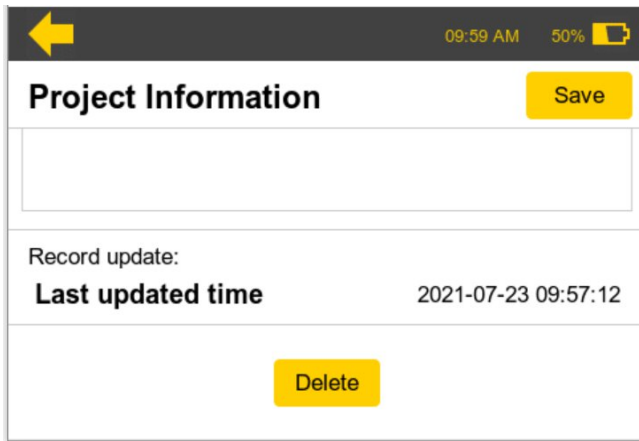

09:59 AM 50%

Project Information Save

Record update:
Last updated time 2021-07-23 09:57:12

Delete

3. Click **Delete** at the bottom of the page to delete the project.



ATTENTION!

After the project is deleted, all the leak data included in this project will also be deleted and cannot be retrieved.

10.6 Export project files

The measurement data are in CSV format and json format, and the pictures and voice memos are saved in separate folders.

There are 2 ways to export the leak files:

- Export to a USB drive
- Copy from S531 to PC

10.6.1 Export to a USB drive

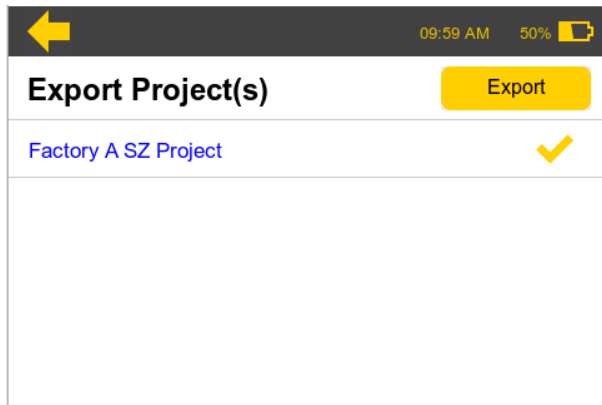

1. Insert the USB drive to the S531.
2. Access **Menu > Export Project(s)**.
3. Select the project to be exported. By default, the current project is selected. You can select multiple projects.
4. Press **Export**.
Note: Only after clicking **Export**, the CSV and json files are created in project folder of the S531 and exported to USB drive. If you do not click **Export**, only the pictures and voice files can be found in the project folder.

10.6.2 Copy from S531 to PC

Note: This operation can be performed only after exporting project files to USB is complete.

1. Use the Type-C cable supplied with the S531 to connect the S531 and PC.
2. Copy the project files in the project folder of the S531 to the PC.

10.7 Import project files to LMS

Importing leak files to the LMS must be done in the LMS. For the descriptions, see LMS online help.

11 Maintenance

This chapter describes the basic maintenance operations.

11.1 Self-test

Access **Menu > Self Test**, you can self test the S531 components in the following table.

Component	Normal behavior
Display	The screen keeps displaying different colors in cycle.
Microphone	If you talk to the microphone, the corresponding sound wave is displayed on the screen.
Speaker	You can hear a piece of music.
Camera	The object that is facing against the camera is displayed on the screen.

11.2 Update the firmware

The S531 firmware consists of device firmware and sensor firmware. You receives an email notification when the new version of the device or sensor firmware are available. Based on the instructions stated in the email, download and update the certificate via the S531 menu.

The steps for updating these two types of firmware are basically the same. The following gives an example of updating the device firmware.

Notes:

- After the device firmware is updated, it does the following to the S531:
 - Reset the S531 user settings to the factory defaults.
 - Delete the leak data except the photo, voice recording and CSV files from the storage card.

To avoid losing the leak data, before the updating, please upload the leak data to the LMS. If you need the leak data in the CSV format, make sure that you generate the CSV file before uploading the leak data to LMS.

- Updating the sensor firmware does not take the preceding actions on the S531.

Preparation:

Copy the new firmware to the root directory of the Type-C USB stick included in the delivery package.

Steps:

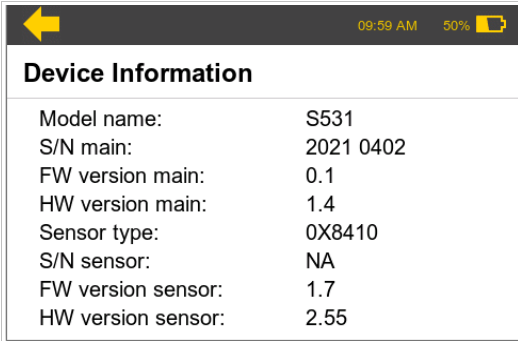

1. Access **Menu > Device Information** to view the current firmware version.

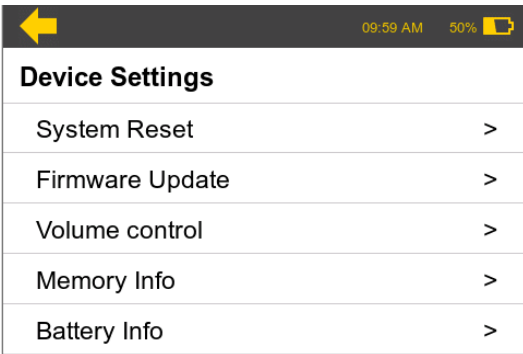

2. Access **Menu > Device Setting > Firmware Update**.

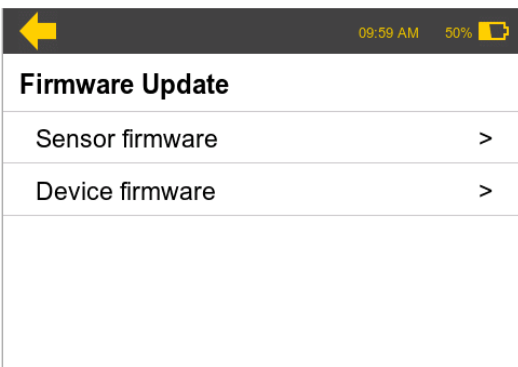

3. On the screen that appears, click **Device firmware** as needed.

Note: To update the sensor firmware update, click **Sensor Firmware**.

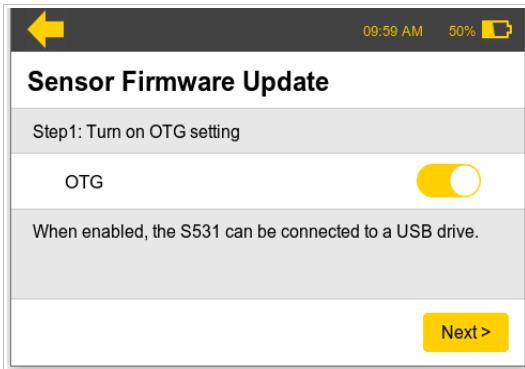

4. On the **Sensor Firmware Update** or **Device Firmware Update** screen, turn on the **OTG** toggle.

5. Click **Next>** to proceed.

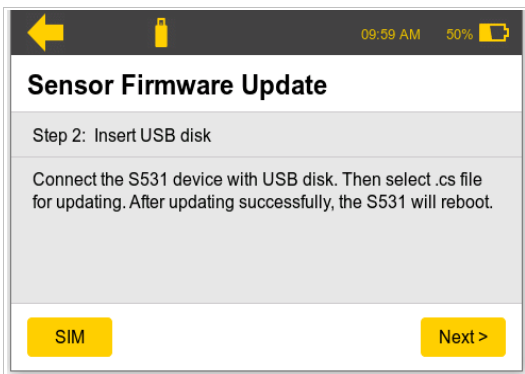

6. Insert the prepared USB stick to the S531.

7. Click **Next>** to proceed.

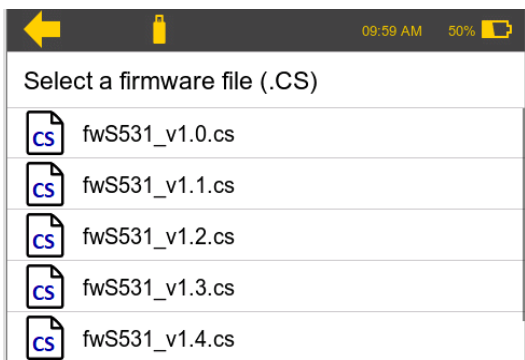

8. On the screen that appears, you can see the files in the root directory of the USB stick. Navigate to the desired firmware file and single click to select.

9. In the *Confirmation* pop-up that appears, click **Yes** to start the update.

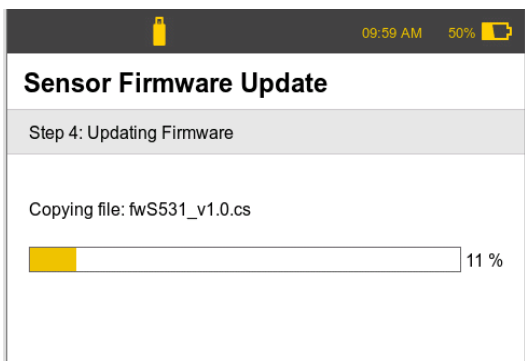

10. Wait until the firmware update is completed.

After the update process is completed, the S531 restarts automatically.

11.3 Reset the device

In case you want to restore the ex-factory settings, you can perform the system reset.

Access **Menu > Device Settings > System Reset**. It takes about five seconds to complete the reset process.

Note: All settings will be cleared, but the leak records including photos and voice recordings will not be deleted.

11.4 Clean the sensor

To clean the sensor and its accessories, you are recommended to use moist cloth only.



ATTENTION!

Do not use isopropyl alcohol to clean the sensor and its accessories!

12 Optional accessories

Ultrasonic transmitter is an optional accessory that is used in pressure-less systems. The generator emits ultrasonic waves that can be detected by S531.

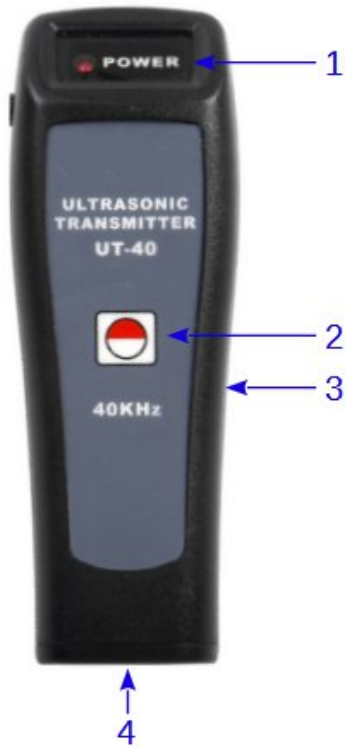

Specification

- Frequency: 40 kHz
- Power supply internal: two AAA batteries

- 1 Power indicator
- 2 Power ON/OFF button
- 3 Rear battery cover
- 4 Emitter

Note: The ultrasonic transmitter cannot turn off automatically. When you do not use it, turn off the power to extend battery life.



For example leak test at a tank:

If an ultrasonic transmitter is inside of a tank, the ultrasonic which is produced by the generator can flow through leaks and detected by the S531.

13 Disposal or waste



Electronic devices are recyclable material and do not belong in the household waste.

The sensor and its accessories and packings must be disposed according to your local statutory requirements. The disposal can also be carried out by the manufacturer of the product. Please contact the manufacturer for details.

14 Appendix: Headset Usage

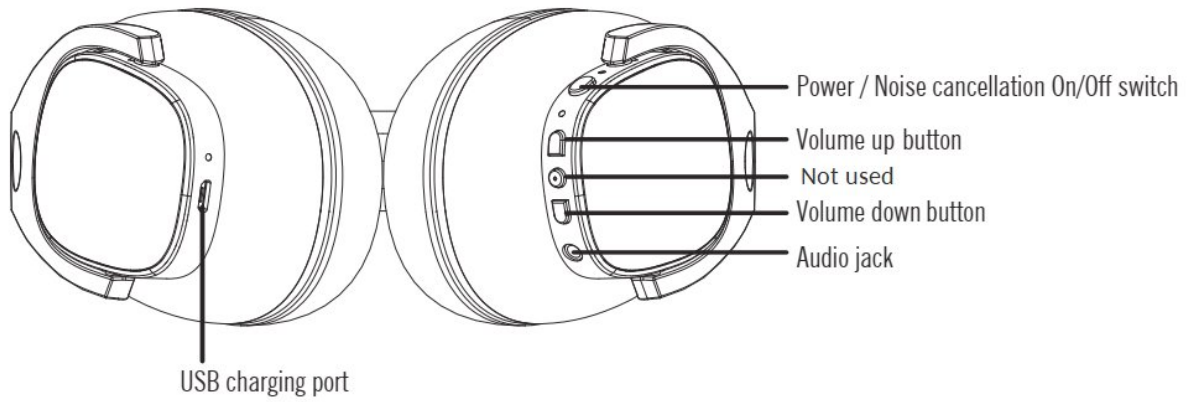

Note: The Volume up and down buttons work only when the headset is used as a wired headset.

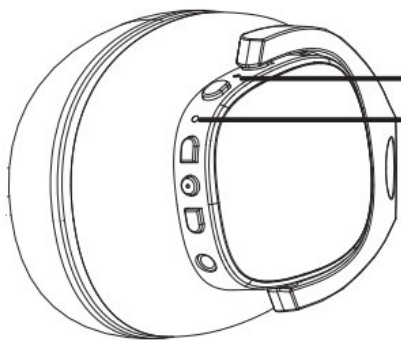

Indicator	Headset status
Solid green	Noise Cancellation ON

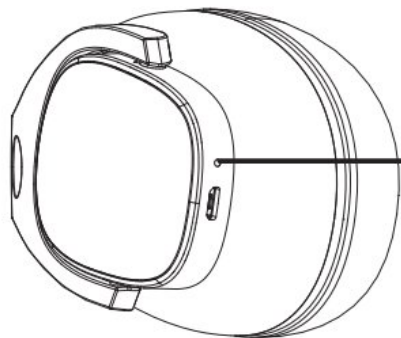

Indicator	Headset status
Solid blue	Wireless is connected
Flashing blue	Wireless is disconnected

Indicator	Headset status
Solid red	Charging

14.1 Power on or off

Press and hold the  button for 2 seconds.
You hear the power-on tone.

Note: Noise cancellation is enabled when the power is turned on.



Press and hold the  button for 2 seconds.
You hear the power-off tone.

14.2 Turn on or off Noise Cancellation

1. In the power-off state, press and hold  for 2 seconds. You can hear the voice prompting POWER ON. Meantime, Noise Cancellation is turned on as well.

2. To turn off Noise Cancellation in the power-on state, click the  button.

After the Noise Cancellation is turned off, you can hear a voice prompting ANC IS OFF.

3. To turn on Noise Cancellation in the power-on state, click the  button.

After the Noise Cancellation is turned off, you can hear a voice prompting ANC IS ON.

Note: The noise cancelling function only works when the headset is powered on.

14.3 Use headset in the wireless mode

1. Make sure that the audio cable is not plugged into the headset.
2. Power on S531 and make sure that the **Wireless headset** toggle is switched on.
3. Press and hold the  button for 2 seconds to power on the headset. If the headset has been paired with the S531, the Bluetooth connection between the headset and the S531 is automatically established.

After successfully connected, you can see the headset icon on the S531 screen.

Note: If the COWIN E9 headset is not the one shipped with the S531, you need to pair it with your S531 on your own. For operation, see section [14.5 Pairing a new headset with the S531](#).

14.4 Use headset in the wired mode

When the headset is working in the wireless mode, if needed (for example, low battery or to hear the weak leak signal) you can make it work in the wired mode. Two ways are available to achieve this purpose: 1) Switch it from the wireless mode to the wired mode. 2) Work directly in the wired mode.

1. Switch from the wireless mode to the wired mode
After the Bluetooth connection is established between the headset and the S531, connect the S531 to the headset with the audio cable, and the headset switches from the wireless connection to the wired connection automatically.
2. Work directly in the wired mode
 - a. Power off the headset and the S531 if they are powered on.
 - b. Connect the S531 and the headset using the audio cable.
 - c. Power on the S531, and now the headset works in the wired mode.

Notes:

1. When using the wired function in this way, the headset cannot be powered on, so the noise reduction function cannot be used.

2. Now if you power on the headset, the wireless connection is automatically established. At this time, you can unplug the audio cable and use a wireless connection. To switch to a wired connection, just plug the audio cable into the headset and S531 again.
3. The wireless headset is used for listening to leaking sounds, not for listening to voice memo of leak recording.

14.5 Pairing a new headset with the S531

Note: The headset is shipped with the S531 and has been paired before delivery. Only when you purchase a new headset from SUTO, you need to follow the steps below to complete the pairing of the new headset with the S531.

1. Make sure that the audio cable is not plugged into the headset.
2. Press and hold the  button for 2 seconds. You hear the Power-on tone. The headset automatically enters the pairing mode. The blue LED indicator flashes.
3. On the S531, enable the wireless headset function by performing the below steps:
 - A. Navigate to **Menu > Device Setting > Pairing Headset**.
 - B. Switch on the **Wireless Headset** toggle.
4. Click **Refresh**.

The S531 detects the wireless devices nearby and shows "COWIN E9" on its screen.

5. Click **COWIN E9** to pair the S531 with the headset.

When the S531 and the headset are paired successfully, the S531 screen shows "COWIN E9 connected", and the headset has the blue LED indicator always on.

Note: The S531 can only work with the COWIN E9 headset. If the headset is damaged, contact your dealer for a replacement or purchase.

14.6 Care and maintenance

- Keep the product away from humid places to avoid damaging the internal circuit.
- Do not put the product in places exposed to the sun or at high temperatures. The high temperature will shorten the service life of electronic components, damage battery, deform plastic components, and shorten the service life of the leather material on the ear muffs. Please put the device and headphones back in the suitcase immediately after use.
- Do not put the product in cold places to avoid damaging the internal circuit board.
- Do not dismantle the product. Non-professional personnel may damage the product.
- Do not drop, vibrate strongly, strike the product with hard objects to avoid damaging the internal circuit.
- Do not use drastic chemicals or cleaners to clean the product.
- Do not use sharp objects to scratch the product to avoid damaging the shell and affecting the product's appearance.

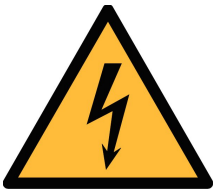

WARNING!

To guarantee your personal safety, please do not wear or keep headphones in the vicinity (closer than 10 cm) of a pacemaker.



ATTENTION!

The maximum charging voltage is 5 V. Inappropriate charging may cause severe damage, fire, or electrocution hazard.

SUTO iTEC GmbH

Grißheimer Weg 21
D-79423 Heitersheim
Germany

Tel: +49 (0) 7634 50488 00
Email: sales@suto-itec.com
Website: www.suto-itec.com

SUTO iTEC (ASIA) Co., Ltd.

Room 10, 6/F, Block B, Cambridge Plaza
188 San Wan Road, Sheung Shui, N.T.
Hong Kong

Tel: +852 2328 9782
Email: sales.asia@suto-itec.com
Website: www.suto-itec.com

SUTO iTEC Inc.

5460 33rd St SE
Grand Rapids, MI 49512
USA

Tel: +1 (616) 800-7886
Email: sales.us@suto-itec.com
Website: www.suto-itec.com

All rights reserved ©

Modifications and errors reserved

S531_IM_EN_V2025-1