

Instruction and Operation Manual

S600

Portable Compressed Air Purity Analyzer



Dear Customer,

Thank you for choosing our product.

Before starting up the device, please read the manual in full and observe the operating instructions stated. The manufacturer cannot be held liable for any damage which occurs as a result of non-observance or non-compliance with this manual.

Should the device be tampered with in any manner other than a procedure which is described and specified in the manual, the warranty is void and the manufacturer is exempt from liability.

The device is designed exclusively for the described application.

We offer no guarantee for the suitability for any other purpose. We are also not liable for consequential damage resulting from the delivery, capability or use of this device.

Revision: 2025-2



Last modifications: February, 2025

Table of Contents

1	Safety instructions.....	5
2	Registered trademarks.....	8
3	Application.....	9
4	Features.....	9
5	Technical data.....	10
5.1	General data.....	10
5.2	Electrical data	11
5.3	Accuracy.....	11
5.4	Total air consumption.....	11
6	Dimensional drawings.....	12
7	Installation on site.....	14
7.1	Compressed air inlets and outlet.....	15
7.2	Compressed air connections.....	16
7.2.1	Installation requirements.....	16
7.2.2	When the isokinetic sampling device is equipped	18
7.2.3	When the isokinetic sampling device is not equipped.....	19
7.3	Electrical connectors.....	20
7.4	Electrical connections.....	21
7.4.1	TCP/IP networking (Modbus/TCP).....	21
7.4.2	Connecting with the isokinetic sampling device.....	21
7.4.3	Connecting with a PC or an OTG USB memory stick.....	21
8	Setup and configuration.....	22
9	Operation.....	23
9.1	Main screen.....	24
9.1.1	Quick buttons and icons.....	24
9.1.2	Icons in the status bar.....	24
9.2	Value view.....	25
9.3	Graphic view.....	25
9.4	Menu.....	26
9.5	Configure S4A remote connection.....	27
9.6	SIM card requirement for 4G option.....	28
9.6.1	Data traffic.....	28
9.6.2	PIN code protection.....	28
9.6.3	Network settings.....	28
10	Guided measurement.....	29
10.1	Steps for guided measurement.....	30
10.2	Reports for guided measurements.....	35
10.3	Export PDF reports.....	35
10.3.1	Export to USB stick via the USB port.....	35
10.3.2	Export via the S4A software.....	37

- 10.3.2.1 Via USB port.....37
- 10.3.2.2 Via Ethernet connection.....38
- 10.3.2.3 Via S4A remote communication connection39
- 10.3.2.4 Export PDF reports.....40
- 11 Optional accessories.....44
- 12 Maintenance.....44
- 13 Calibration.....44
- 14 Disposal or waste.....45
- 15 Warranty.....45
- 16 Appendix - Modbus Interface.....46

1 Safety instructions

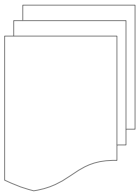

Please check if this instruction manual matches with the product type.

Please observe all notes and instructions indicated in this manual. It contains essential information which must be observed before and during installation, operation and maintenance. Therefore this instruction manual must be read carefully by the technician as well as by the responsible user / qualified personnel.

This instruction manual must be available at the operation site of the instrument at any time. In case of any obscurities or questions, regarding this manual or the product, please contact the manufacturer or your customer support.



WARNING!

Compressed air!

Any contact with quickly escaping air or bursting parts of the compressed air system can lead to serious injuries or even death!

- Do not exceed the maximum permitted pressure range (see sensors label and/or the specifications written in this manual).
- Only use pressure tight installation material.
- Avoid that persons get hit by escaping air or bursting parts of the instrument.
- The system must be pressure less during maintenance work.

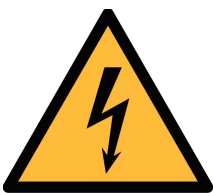

WARNING!

Voltage used for supply!

Any contact with energized parts of the product may lead to a electrical shock which can lead to serious injuries or even death!

- Consider all regulations for electrical installations.
- The system must be disconnected from any power supply during maintenance work.

**Laser
Safety
Information**

This product contains a laser-based counter that is Class 1 product (as defined by 21 CFR, Subchapter J of the Health and Safety Act of 1968) when used under normal operation and maintenance. Service procedures on the counter can result in exposure to invisible radiation. Service should be performed only by factory-authorized personnel.

**ATTENTION!****Permitted operating parameters!**

Observe the permitted operating parameters. Any operation exceeding this parameters can lead to malfunctions and may lead to damage on the instrument or the system.

- Do not exceed the permitted operating parameters as specified in the data sheet, this manual or written on the instrument.
- Make sure the product is operated in its permitted limitations.
- Do not exceed or undercut the permitted storage and operation temperature, pressure and humidity.

The product should be maintained and calibrated frequently, at least annually. For more information, please contact the customer support.

General safety instructions

- It is not allowed to use the product in explosive areas.
- Please observe the national regulations before/during installation and operation.

Remarks

- It is not allowed to disassemble the product.
- Always check the compressed air connectors in terms of stability and tightness before any operation.

**ATTENTION!****Measurement values can be affected by malfunction!**

The product must be installed properly and frequently maintained, otherwise it may lead to wrong measurement values, which can lead to wrong results.

- The instrument must be operated within or better than compressed air quality Class 4.5.4 according to the ISO8573-1. If the air quality cannot reach the specified Class, the device may show wrong measurement values or even may get damaged.
- Do not exceed the maximum operation temperature or pressure.
- Avoid condensation inside the instrument caused by the supplied air or gas because it harms the instrument and affects the accuracy.
- It is recommended that before any operation you examine the instrument in terms of the measurement accuracy and deviations. To do this, you may use high efficiency filters for oil vapor and particle, and the instrument should show low values close to zero. Additionally, it is recommended you examine the dew point measurement to ensure it is working correctly. To do this, you may use a dry gas with a defined dew point value which should be reached within several minutes. Or you may use any reference meter. Only after doing these examinations, you can rely on the measurement results after the instrument have been used for other measurement cycles.
- Always perform a visual inspection in prior to every measurement before connecting compressed air. If any loose objects are found, do not connect the compressed air because it may lead to a damage or injuries.

Storage and transportation

- Make sure that the transportation temperature is between -10 ... 50°C.
- For transportation it is recommended to use the packaging which comes with the sensor.
- Please make sure that the storage temperature of the sensor is between -10 ... 50°C.
- Avoid direct UV and solar radiation during storage.
- For the storage the humidity must be < 90%, no condensation.
- During transportation the instrument should always be handled with care, otherwise the internal sensors may get damaged and the measurement results may differ.



ATTENTION!

Equipment may get damaged!

Please make sure, that your measuring point is free of excessive contamination/dirt. This should be maintained before every measurement.

- Observe the measuring point always before measurement if it is free of contamination like water drops, oil drops or other rough contaminants.
- Should water hit the inner electronics, the sensors could be seriously damaged.
- Any rough contamination of particles, water, oil or other impurities may damage the instrument or affect the accuracy.
- Check your measurement point with the enclosed test kit, by purging air in prior to the use of the instrument through the test kit. A clean tissue may help to identify oil, water or any other lubricants in the air.

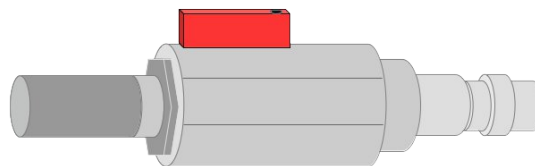

2 Registered trademarks

SUTO®	Registered trademark of SUTO iTEC
MODBUS®	Registered trademark of the Modbus Organization, Hopkinton, USA
HART®	Registered trademark of the HART Communication Foundation, Austin, USA
Android™, Google Play	Trademarks of Android™, Google Play

3 Application

The S600 is an all-in-one Portable Compressed Air Purity Analyzer. It measures, records and verifies particle concentration, dew point, oil vapor, temperature, and pressure in a compressed air system.

The S600 is mainly used in industrial environments, and is not developed to be used in explosive areas.

4 Features

- High-resolution 5" color touchscreen display and interface.
- Software guided measurement.
- USB port for transferring the data to a USB-OTG memory drive.
- Ethernet (Modbus/TCP and dedicated Bus) interface for transferring the data to a SCADA systems.
- Data logger with the capacity of 100 million values.
- Integrated report generator for compressed air audits, used to generate PDF files and copy them to a USB memory drive.
- All-in-one portable hand carried measurement device.
- Multiple dew point measurement system for a wide range of measurement and a very high accuracy.
- Latest PID sensor technology for oil vapor measurement.
- Laser particle counter for particle detection.
- All-in-one device measuring five parameters in a single device: Particle counter, dew point, oil vapor, temperature and pressure.
- The detection limit of oil vapor down to 0.001 mg/m³.
- Provides various measurement units for your choice, such as Pressure: bar, MPa, psi, Particle: cn/m³, cn/ft³, Oil content: mg/m³, ppm, Temperature: °C, °F, Dew point: °C Td, °F Td, mg/m³.
- Isokinetic sampling device for particle measurement according to ISO8573-4 as an option.
- With optional 4G feature (P/N: A1670) and dedicated S4A software, you can check the online measurement values, read out the logging files remotely.

5 Technical data

5.1 General data

CE FC		
Parameter	Measuring parameter	Range
	Particle	0.1 < d ≤ 0.5 μm 0.5 < d ≤ 1.0 μm 1.0 < d ≤ 5.0 μm d > 5.0 μm
	Dew point	-100 ... +20°C Td
	Oil vapor	0.001 ... 5.000 mg/m ³
	Pressure	0.3 ... 1.5 MPa 43.5 ... 217.6 psig
	Temperature	0 ... +50°C
	Reference settings	ISO 1217, 20°C 1000 mbar
Measurement principle	Parameter	Principle
	Particle quantity	Laser optical detection
	Dew point	Ceramic humidity sensor, oscillating crystal
	Oil vapor	PID
	Volume flow	Thermal mass flow (Anemometer)
Resolution of oil vapor sensor	0.001 mg/m ³	
Medium	Compressed Air, Nitrogen N ₂ , Carbon dioxide CO ₂	
Humidity of medium	< 40%, non condensation	
Medium temperature	0 ... +50°C	
Operation pressure	0.3 ... 1.5 MPa 43.5 ... 217.6 psig	
Interface	USB Ethernet (Modbus/TCP) 4G/LTE (Optional)	
Display	Touchscreen, Size: 5", Resolution: 800 x 480 px	

Data logger	Internal, 100-million values
UV lamp lifetime	6,000 working hours or 1 year, whichever comes first
Housing material	PC + ABS, Aluminum
Protection class	IP54 (cover closed)
Dimension	Please observe the drawings on the next page
Display	5" color touch screen, 800 x 4800 Pixels
Weight	9.8 kg

5.2 Electrical data

Power supply	Mains supply adapter (AC/DC) Input: 100 ... 240 VAC, 50/60 Hz, 1.4 A Output: 24 VDC, 2.5 A, 60 W max
--------------	--

5.3 Accuracy

Counting Efficiency (Per ISO 21501-4)	30 ... 70% of $d > 0.1 \mu\text{m}$ 90 ... 110% of $d \geq 0.3 \mu\text{m}$
Dew point	$\pm 1^\circ\text{C Td}$ (0 ... 20°C Td) $\pm 2^\circ\text{C Td}$ (-70 ... 0°C Td) $\pm 3^\circ\text{C Td}$ (-100 ... -70°C Td)
Oil vapor	5% of value $\pm 0.003 \text{ mg/m}^3$
Isokinetic sampling device	3% of RDG

5.4 Total air consumption

Input pressure (bar)	With isokinetic sampling device (l/min)	Without isokinetic sampling device (l/min)
3	~25	~9
7	~100	~21
10	~228	~30
15	~500	~45

6 Dimensional drawings

Dimensions of S600 in mm (cover closed):

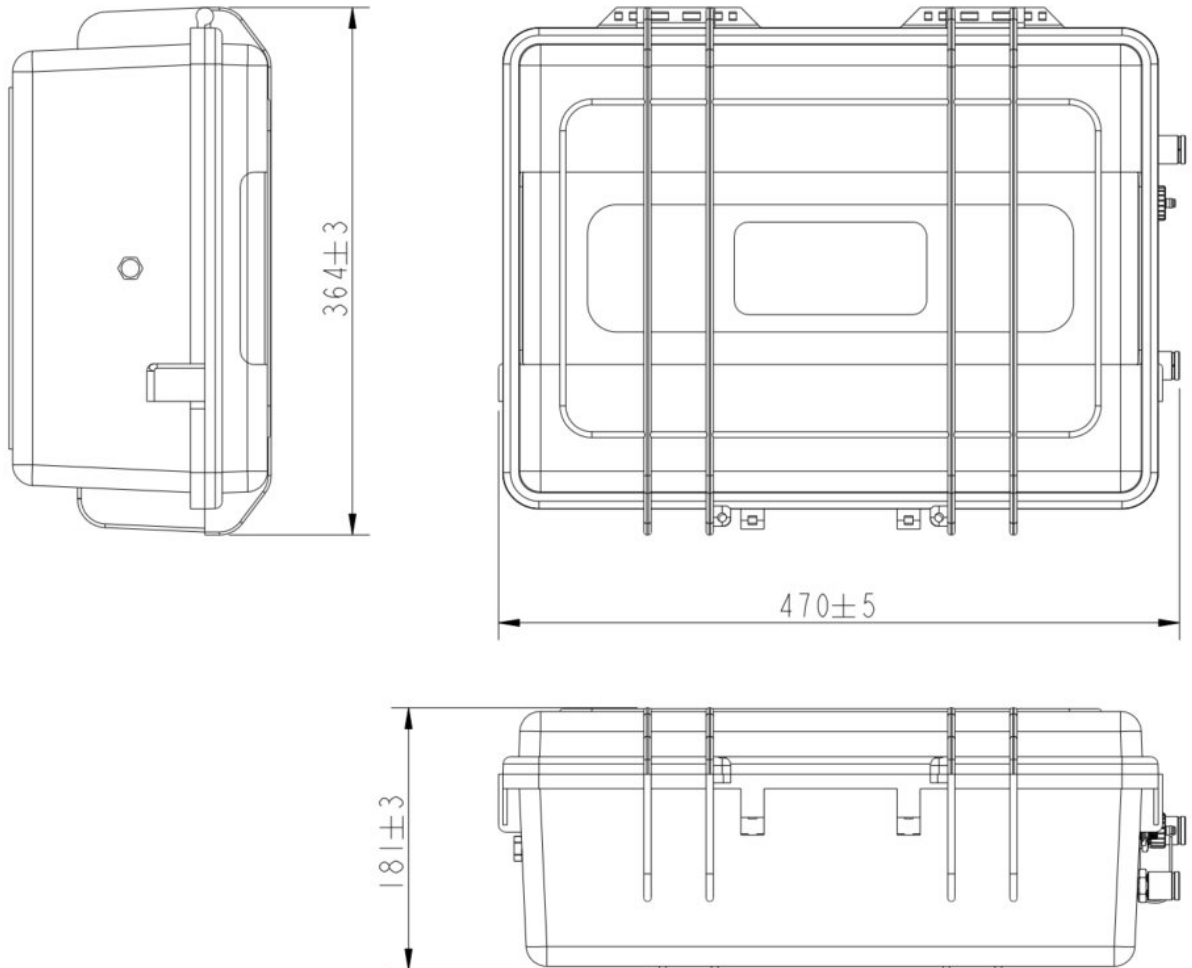

Dimensions of the isokinetic sampling device (optional) in mm:

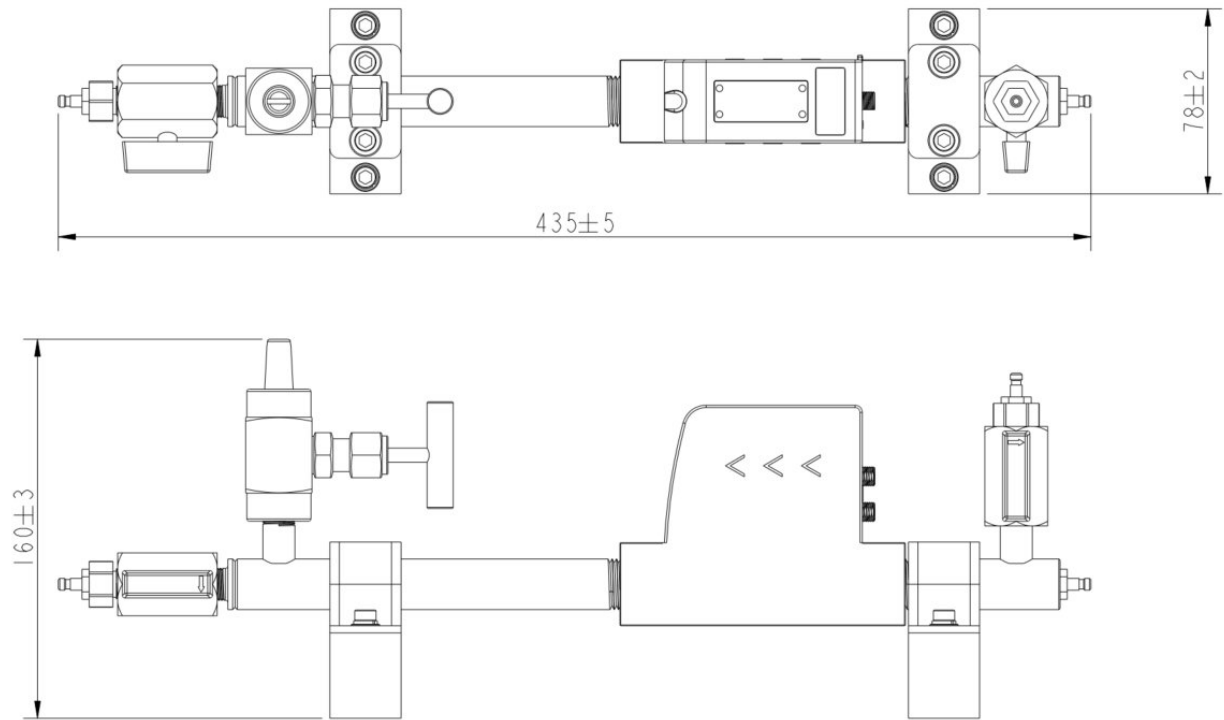

7 Installation on site

Please make sure that all components listed below are included in your package.

Qty.	Description	Item No.
1	Portable Compressed Air Purity Analyzer in a hand carry case with handle and shoulder belt	
1	USB OTG memory stick	
1	Purge filter for pre-measurement (test kit)	P560 0600
1	Power supply, 230 VAC / 24 VDC 50/60 Hz	
2	1.5 m Teflon hose with a quick connector and a compressed air coupling at each ends	
1	Operation and instruction manual	
1	Certificate of calibration	
1	USB 4G dongle, including S4A software (Option)	A1670

The following items are included only if you have ordered the isokinetic sampling device.

1	Isokinetic sampling device, including a flow sensor	
1	Connection cable to S600 with an M12 and an M8 connectors at each end	
1	150 mm connection tube, both ends quick couplings	A554 0600
1	700 mm connection tube, both ends quick couplings	
1	1.5 Connection tube with a quick connector and a compressed air coupling at each end	
1	Certificate of calibration	

To replace materials for items in the preceding list or buy accessories, please contact the manufacturer or your local distributor.

7.1 Compressed air inlets and outlet

On the right side of the S600 housing, there are two compressed air inlets. On the left side, there is one outlet.

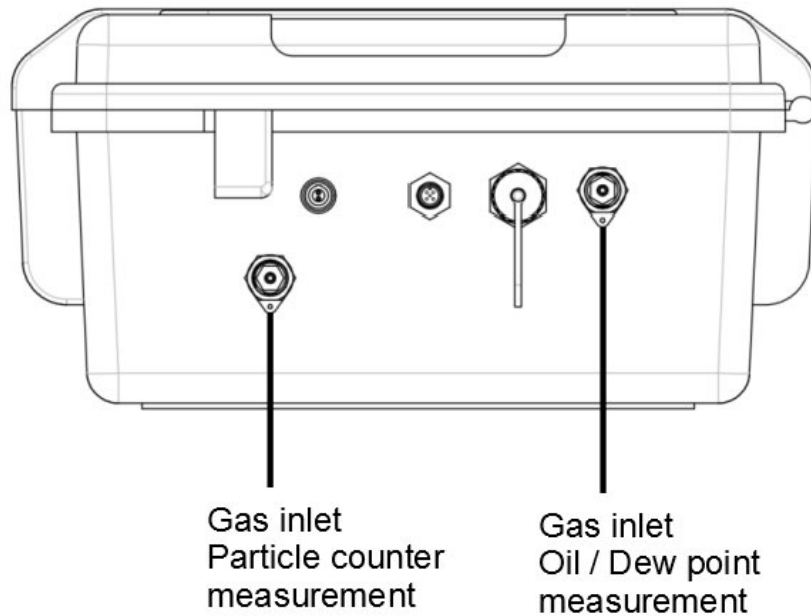

Right view



ATTENTION!

Permissible pressure!

Please observe the maximum permissible inlet pressure. It must be in between 0.3 and 1.5 MPa. If the pressure exceeds this range, it will damage the device. If the pressure is too low, the volumetric flow will not be high enough, which leads to wrong results.

7.2 Compressed air connections

7.2.1 Installation requirements

Make sure that your installation meets the following requirements:

- The device must be set up next to the measuring point. Please make sure that the device is put on a flat surface. If you are using the additional isokinetic sampling devices, make sure that it is also standing on a flat surface next to the S600.
- The tubes should be not bended heavily and should be installed with a big curve radius to avoid turbulence in the air flow.
- The isokinetic sampling device must be set up next to the S600 to achieve a straight and short connection. Please observe the following section to connect the isokinetic sampling device to the S600.
- Connect the S600 to the power during the measurement, and make sure that the device is not turned off or plugged off during the measurement because data will then be lost and not saved.



ATTENTION!

If the device is not installed properly it may lead to wrong measurement results.

- The device is designed to be operated indoors only. To use the device outdoors, please protect the device from direct sunlight and rain.
- Before you start the measurement, check your point of measurement for contaminants.



ATTENTION!

Before you connect the device to your point of measurement, make sure that there is no rough contamination like water/oil drops or heavy dust. This may damage the sensor units. For this please use the purge filter test kit.

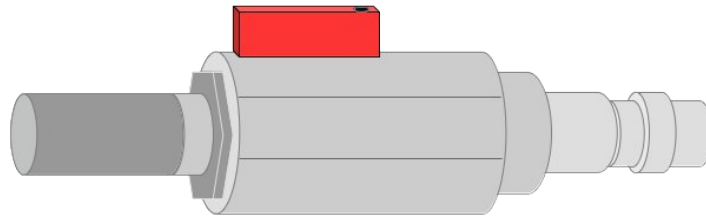

Steps to check:

1. Connect the purge filter test kit onto your measuring point first. Open the purge valve on the test kit and purge air for a short period.
2. Check the filter in the test kit to see whether it shows high contamination of water, oil or dust.
3. If the filter is contaminated severely, stop using the S600 for measurement because this may lead to serious damage to the device. In case you are not sure, please contact the manufacturer.

7.2.2 When the isokinetic sampling device is equipped

The following figure shows the S600 connection with the isokinetic sampling device.

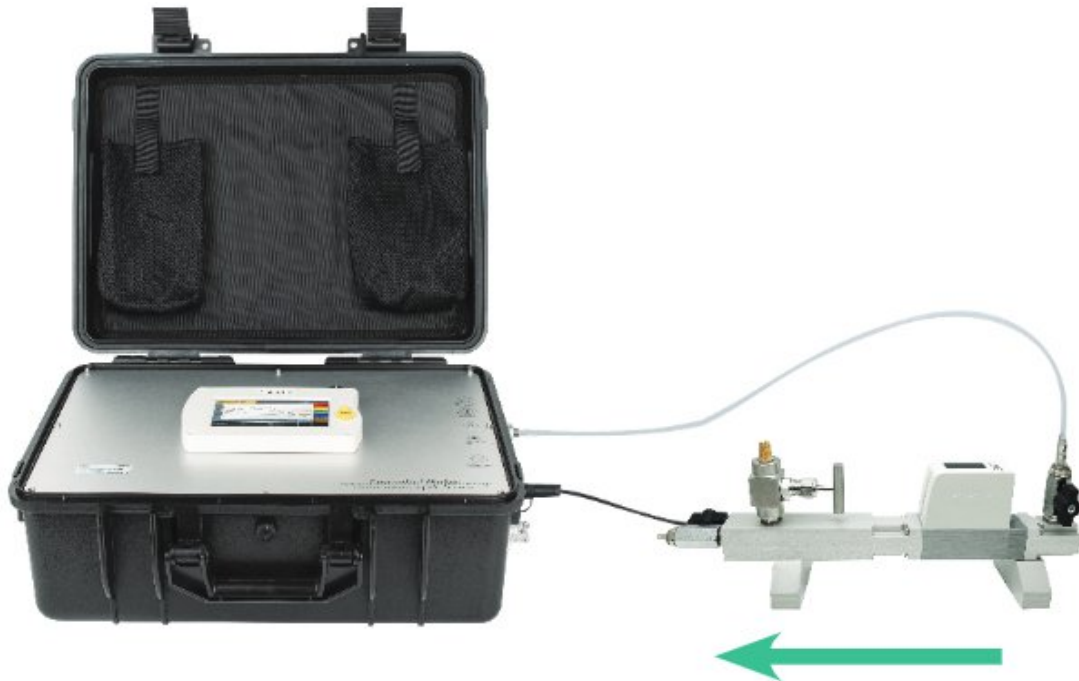

Connect the isokinetic sampling device using the teflon hose delivered with the device. The following illustrates which outlets of the sampling device need to be connected to which inlets of the S600.

The following procedure describes how to set up the connection.

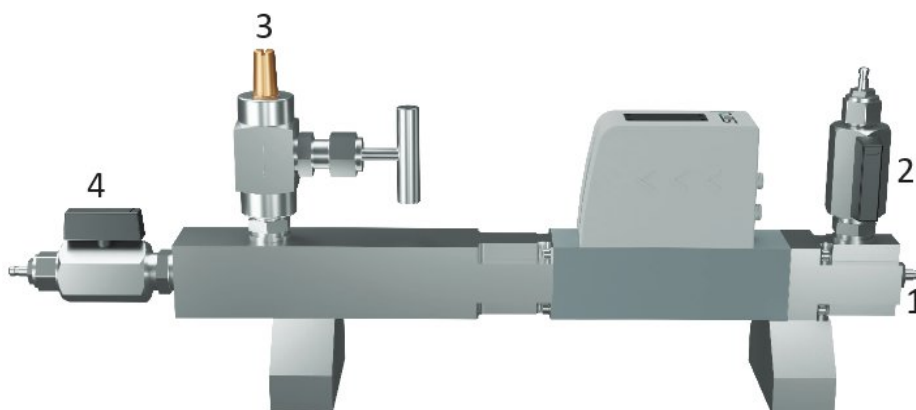

1. Before connecting the isokinetic sampling device to your compressed air, make sure that ball valve **2** and **4** are **closed**.
2. Close **the needle valve 3** fully.
3. Connect your compressed air system to the **inlet 1** of the isokinetic sampling device using the supplied 1.5 m Teflon hose

(Use the quick connector to connect with inlet 1, and the compressed air coupling to connect with your compressed air system).

4. Remove the protection caps from the two inlets of the S600.

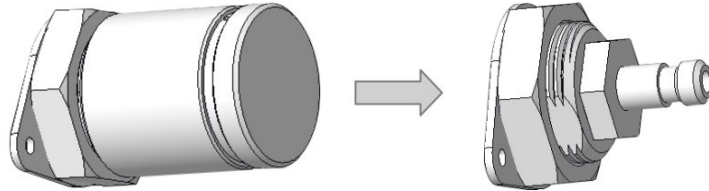

5. Connect the **valve 2 outlet** with **the inlet for dew point and oil vapor measurement** at the S600 using the 700 mm Teflon hose.
6. Connect the **valve 4 outlet** with the **inlet for the particle counting** at the S600 using the supplied 150 mm Teflon hose.
7. Now open the **valves 2** and **4** to pressurize the instrument.

Note: Always open the valves slowly and carefully. In case that you hear or see any damage on the device, please close the valves and disconnect the compressed air supply.

7.2.3 When the isokinetic sampling device is not equipped

1. Remove the protection caps from the two inlets of the S600.
2. Using the supplied Teflon hoses, connect your compressed air system to the two inlets at the S600.

Notes:

- Make sure you are using clean and oil-free components when connecting the instrument.
- The compressed air supply must always be applied carefully. In case you are using ball valves, open them carefully and slowly. If you observe any unexpected noise or air leakage, shut down the compressed air supply immediately and disconnect the instrument.

7.3 Electrical connectors

The S600 provides four electrical connectors:

- A USB port on the S600 face panel.
- The following three connectors on the right side of the housing, as shown in below figure.

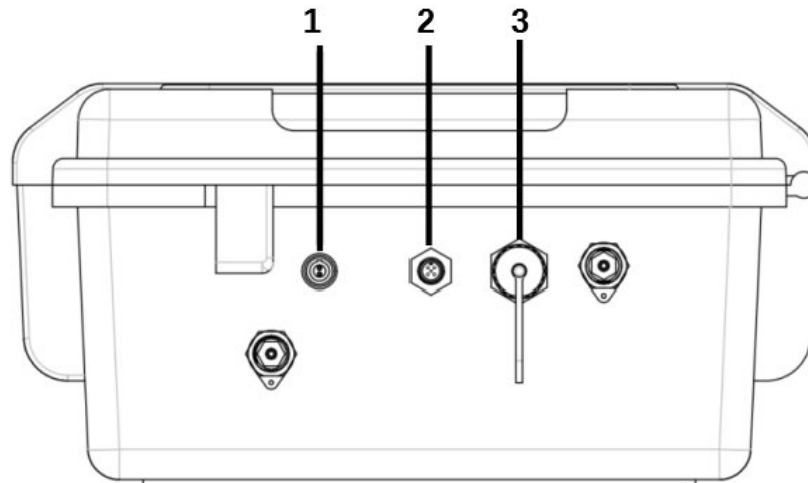

No.	Description
1	Power supply connector
2	M12 connector, communication port with the isokinetic sampling device
3	RJ-45 connector, Ethernet port for IP networking



ATTENTION!

Only use the power supply which comes with the S600! If any other supply is used, the instrument may get damaged.

7.4 Electrical connections

7.4.1 TCP/IP networking (Modbus/TCP)

Through the RJ-45 connector, the S600 can be connected to the TCP/IP network over the Modbus/TCP protocol.

Remove the protection cap and plug in the network cable (RJ-45).

For more information about the data attributes of measurement channels, see [Appendix - Modbus Interface](#).

7.4.2 Connecting with the isokinetic sampling device

Through the M12 connector, the S600 can be connected with the sampling device for communication.

Remove the protection cap and plug in the M12 cable provided with the sampling device.

7.4.3 Connecting with a PC or an OTG USB memory stick

Through the USB port on the S600 face panel, the S600 can be connected with:

- An OTG memory stick: To import firmware for upgrade and to export data.
- A PC where data analysis software such as S4A or S4M is installed: To export data to the PC for analysis.

8 Setup and configuration

The S600 is configured ex-works and ready to work out of the box. The S600 provides a guided measurement procedure to take you through device setup for each measurement parameter. All these setup settings are automatically saved into the device even on a power failure.

For more information about the guided measurement procedure, see chapter [10 Guided measurement](#).



ATTENTION

If you are facing problems setting up you device, contact the manufacturer or your local dealer for assistance.

If power outage occurs during the measurement, the measurement data will not be saved!

9 Operation



After the S600 is powered on, the initialization screen is displayed with an active progress bar.

During the initialization, the device configures the sensors and runs initialization routines.

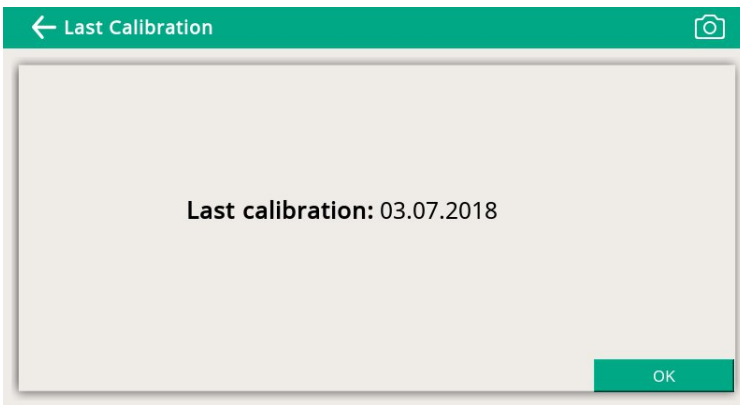

After the initialization is completed, the date of the last calibration date is shown. Click **OK** to proceed.

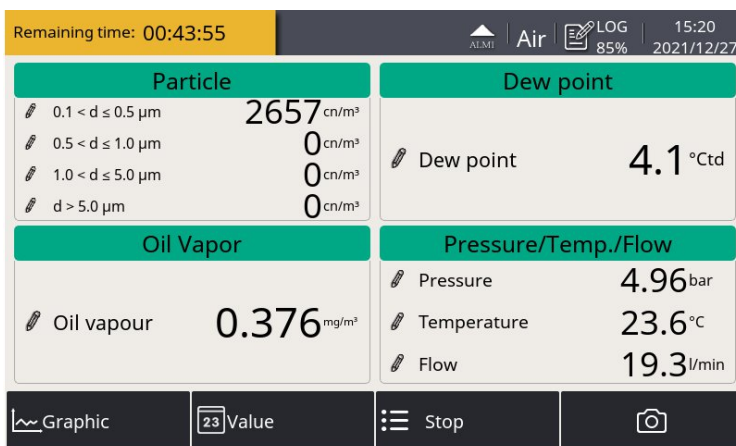

The value screen appears, as shown on the left.

Quick buttons on the bottom bar are described as follows:

- **Graphic:** To switch to the graphic view.
- **Value:** To switch to the value view.
- **Menu:** To access the operation sub-menus.
- **The camera icon:** To take a screenshot.

9.1 Main screen

The following figure shows the main screen in the value view.

9.1.1 Quick buttons and icons

Buttons and icons	Description
	To switch to the graphic view of measurement data
	To switch to the value view of measurement data
	To access the operation menus
	To take a screenshot

9.1.2 Icons in the status bar

	USB memory stick is connected. Press the icon to disconnect the stick.		System errors occur. Press this icon to get further information.
	Calibration is expired. Please contact the manufacturer or your local dealer.		RTC backup battery status
	Alarm triggered		S4A remote connected
	4G/LTE signal strength		
	Data logger status: - STOP—Indicates that the data logger is not running. - LOG—Indicates that the data logger is running.		

9.2 Value view

Shows all measurement values in real-time.

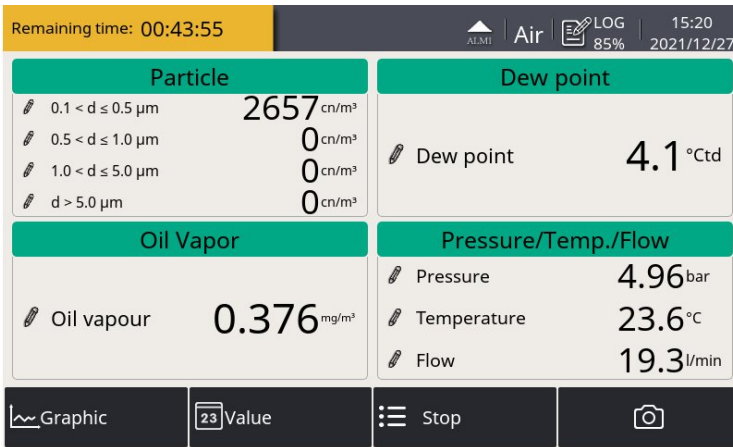

To switch to the value view, click **Value** in the bottom.

Note: During the first five minutes, the S600 performs a purge process to ensure any remaining particles in the system are blown out. During this period, the counting numbers on the **Particle** pane appear green and blinking.

If the sensor data cannot be read out due to some abnormal conditions, the reading of the sensor will be shown ---- on the display.

The operation pressure is 0.3 ... 1.5 MPa. If the inlet pressure is not within this range, the reading for the sensor becomes gray and blinking.

If the dew point of inlet gas is higher than 7°C Td, which is too high and is harmful to the instrument, the reading of dew point will become red and blinking to remind users.

9.3 Graphic view

The graphic view is pre-configured in the factory, and you do not need to change anything.

In case that you need to make changes, follow the instructions indicated in the following figure.

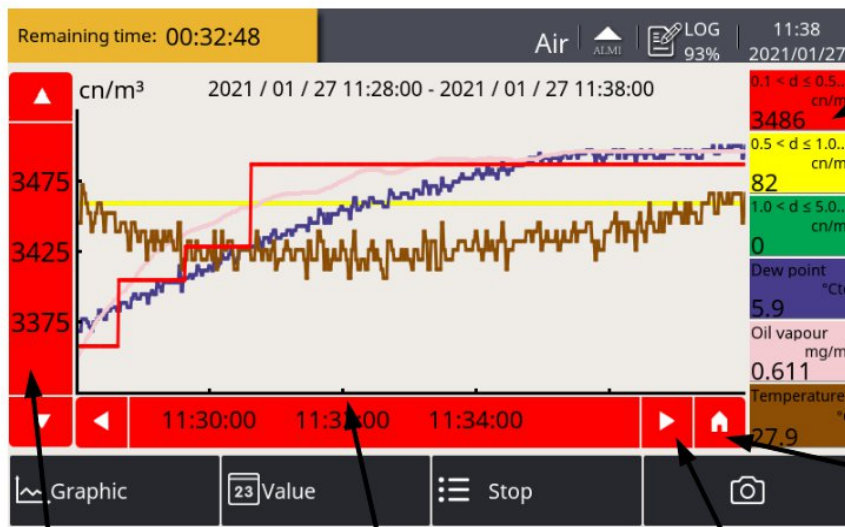

Selected channels and Y-axes:

- 1 touch select Y-axes
- Next touch disables channel
- Long touch is for settings

Home button: brings you back to the current time

Touch Y-axes to scale it

Touch X-axes to define viewing period

Time scrolling

9.4 Menu

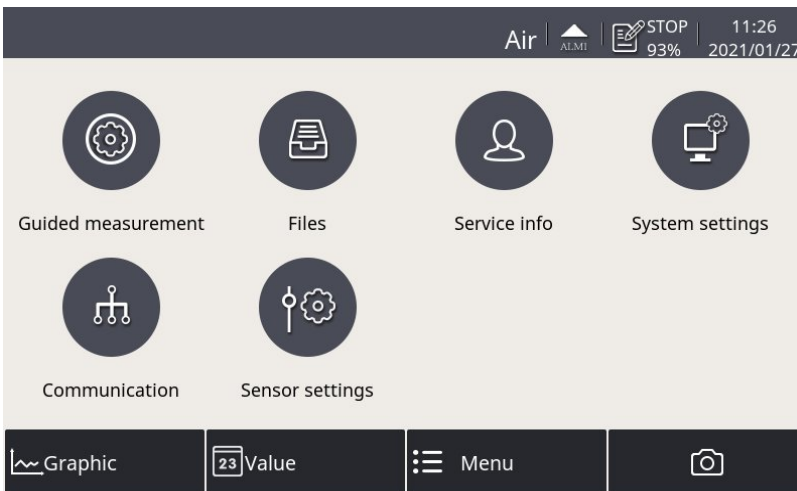

To access the main menu, click **Menu** in the bottom bar. All operation menus are displayed.

These operation menus are described below.

Guided Measurement

To start the guided measurements, which lead you through a complete measurement cycle. For more information, see Chapter [10 Guided measurement](#).

Files

To view, export, and delete the captured screenshots and check the memory status.

Service info

To configure contacts of technical support. You can import a logo file to the S600 through the USB port.

System settings

To configure system-level settings:

- To perform general settings on access code, date, time and language and so on.
 - To view device information, such as the serial number, firmware and hardware versions.
 - To calibrate the touch screen if it does not respond to user inputs correctly or precisely.
 - To update the system firmware.
-

Communication

To configure communication parameters. Only the following sub-menus are applicable to S600:

- **Field-bus Ethernet:** Used to enable the S4M or 3rd party monitoring software to fetch measurement data from the S600. In this sub-menu, select the communication protocol as instructed below, and configure the IP address of the S600:
 - For S4M, select **Proprietary** as the protocol.
 - For 3rd-party software, select **Modbus/TCP Ethernet** as the protocol.
 - **Web transmitter:** Used to enable the S600 to send measurement data to S4M. In this sub-menu, Configure the IP address or domain name of the S4M server.
 - **S4A Remote:** Used to configure the S600 to connect to the S4A remote server, check the measurement values, and read out the logging files via the S4A software.
-

Sensor settings

To change the gas type and units for the measured parameters.

9.5 Configure S4A remote connection

When the optional 4G/LTE function is integrated, follow the steps below to set it up:

1. Configure the S600 to connect it to the S4A remote server.
2. View the online measurement values, and read out the logging files remotely with S4A software.

For the detailed configuration steps, watch the instruction video which can be found online on SUTO website.

9.6 SIM card requirement for 4G option

To establish the 4G/LTE communication between S600 and S4A software with S4A remote function, customer needs to buy a SIM card locally.

9.6.1 Data traffic

Data traffic required per month is 7 GB if the system is running 7×24 hours.

9.6.2 PIN code protection

The S600 does not support modifying PIN code on the screen. If your SIM card has PIN code protection, disable it by using other devices, for instance using your mobile phone.

9.6.3 Network settings

Depends on the Internet Service Provider (ISP) you may need to change the network settings. Click the 4G/LTE signal strength icon  on the status bar to check and change the settings, as shown below.

You can get the APN data from your provider, or they are easy to find if you search for <APN Provider> on the Internet.

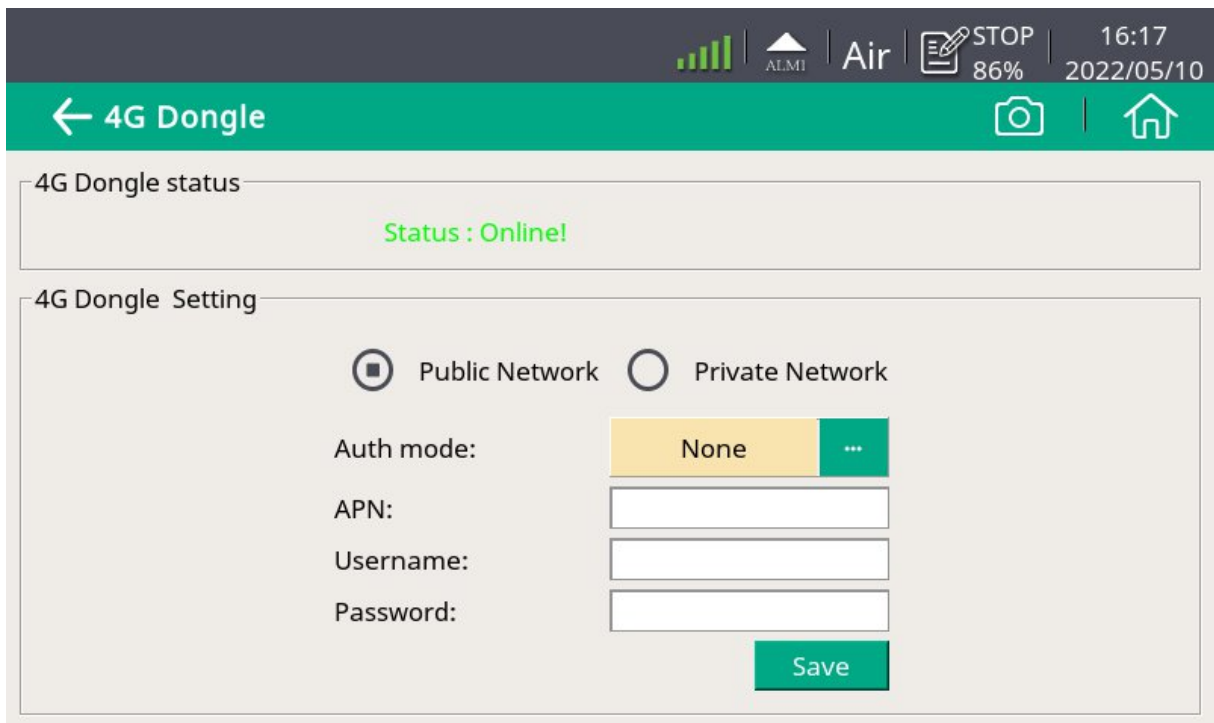

10 Guided measurement

The S600 provides a software-based guided measurement which takes you through the complete measurement. This leads to a simplified measurement process and prevents you from wrong measurements.

To start a guided measurement, do the following:

1. Click **Menu > Guided measurement**.

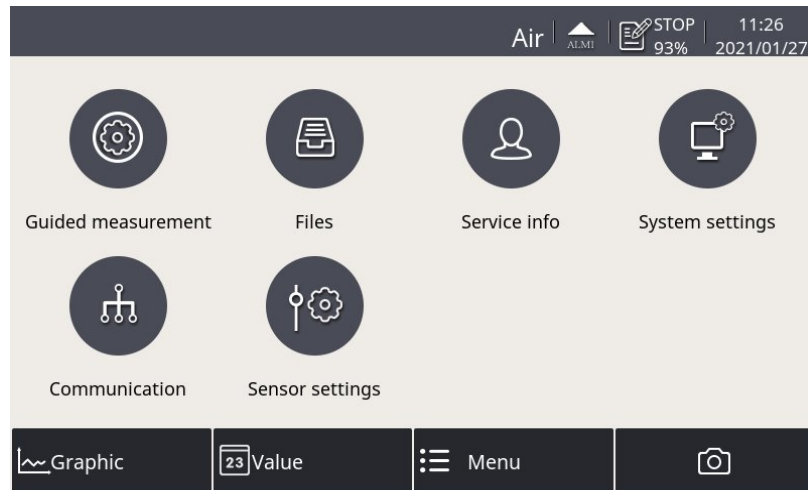

2. Select the type of measurement that you want to perform.

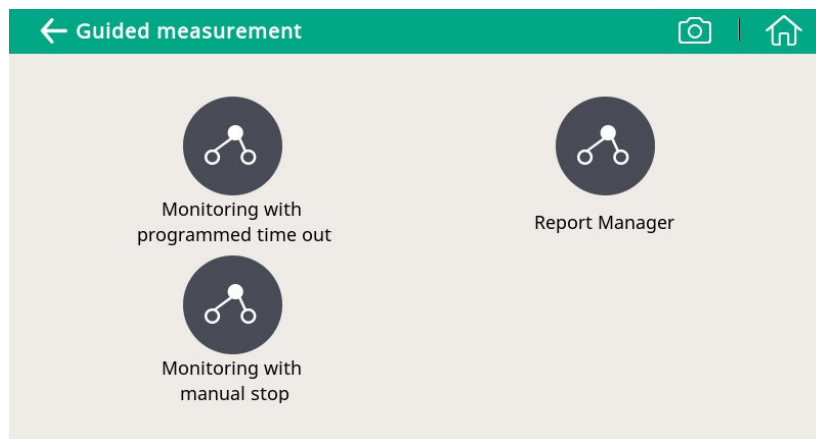

- **Monitoring with programmed time out:** It starts a measurement with a user-programmed period of measurement time. You can set the measurement time during the process of measurement preparation. The system will then, after finishing the programmed measurement duration, stop the measurement automatically and save the data. This mode is ideally used for audits where you must measure at several points. You can program for each point a duration of e.g. 2 hours and then you

- can compare the measurements.
 - **Monitoring with manual stop:** It starts the measurement without a programmed stop time. You can click it to start the measurement and stop it whenever you want. Then you can decide if you want to save or delete the data. This can be used to monitor changes in values.
3. Perform the guided measurement following the onscreen instructions. For more information, see section [10.1 Steps for guided measurement](#).
 4. To view and manage the measurement files generated, click **Report Manager**. For more information, see section [10.2 Reports for guided measurements](#).

10.1 Steps for guided measurement

After you start a guided measurement, follow below steps to go through the whole process.

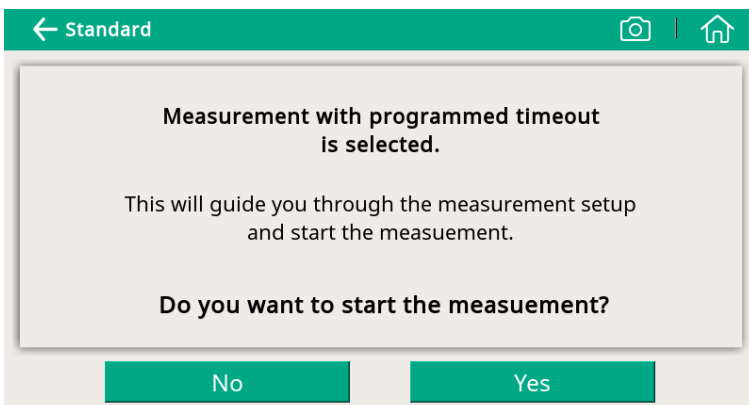

1. An overview is given about the selected measurement types. Click **Yes** to start.

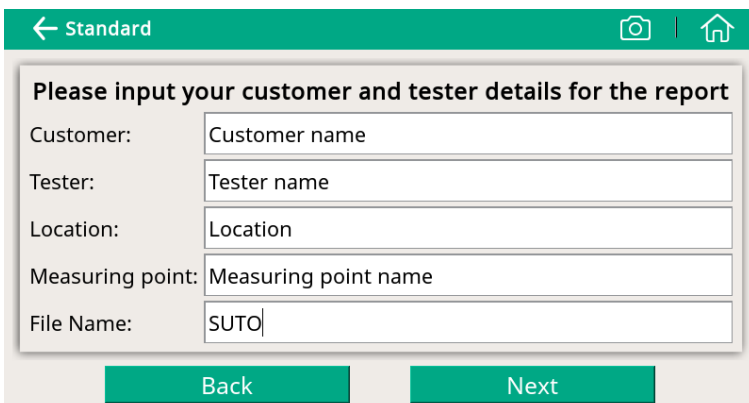

2. Input the customer and tester names, which will be shown on the report.

← Standard

Please input your altitude

Altitude: m (Over sea level)

Back Next

- Input the altitude where the device is placed.
Note: Altitude is needed for an accurate oil vapor measurement. Only positive values are valid. If the altitude is negative, enter 0 instead of the real negative value.

← Standard

Please select the target class of the ISO 8573-1 compressed air purity standard. The selected class will be used for evaluation in the report.

Particle	CLASS 0 custom	CLASS 1	CLASS 2	CLASS 3	CLASS 4	CLASS 5
Dew Point	CLASS 0 custom	CLASS 1	CLASS 2	CLASS 3	CLASS 4	CLASS 5
Oil Vapor	CLASS 0 custom	CLASS 1	CLASS 2	CLASS 3	CLASS 4	CLASS 5

- Select the compressed air class as needed.
Note: ISO8573 stipulates alarm limit values for different classes. CLASS 0 allows you to customize the alarm limit values.

← Standard

Please input the limit values for each channel. These values will be used for evaluation in the report.

Particle: 0.1 < d ≤ 0.5 μm Particles/Nm³

0.5 < d ≤ 1.0 μm Particles/Nm³

1.0 < d ≤ 5.0 μm Particles/Nm³

Dew point: mg/m³

Oil vapor: mg/m³

Back Next

- Enter a limit value for each measurement channel.
(This step is shown only when you selected CLASS 0 in the last step)

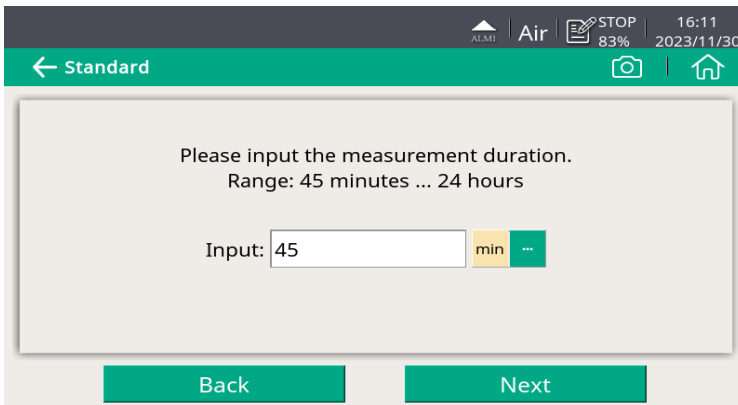

6. Enter the measurement duration.

The longer it takes, the more stabilized the values will be and the more exactly it will approximate to the system conditions.

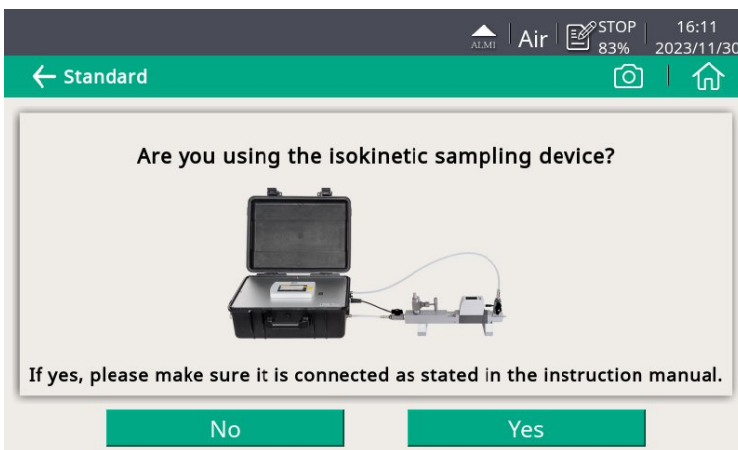

7. The system asks if you are using the isokinetic sampling device, and this will affect the further steps and instructions.

Select **Yes** if you have the isokinetic sampling device connected. Otherwise, click **No**.

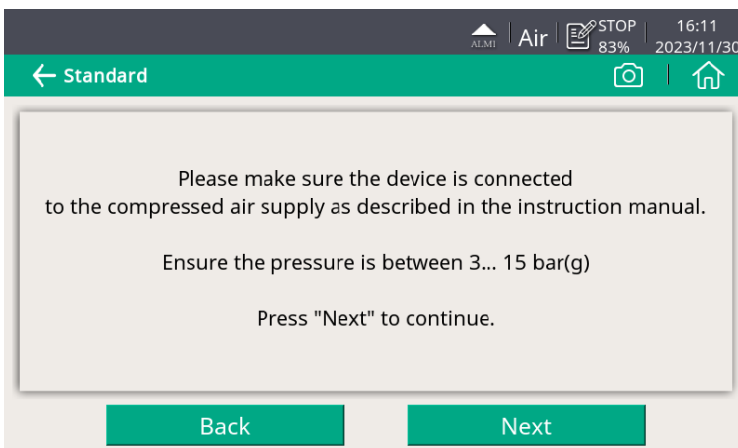

8. The system checks whether the compressed air is connected and the pressure is within the valid range.

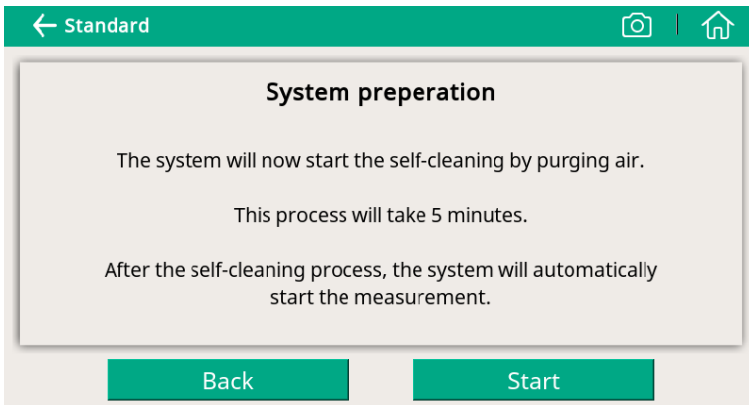

9. System preparation. Click **Start** to start the cleaning and self-calibration.

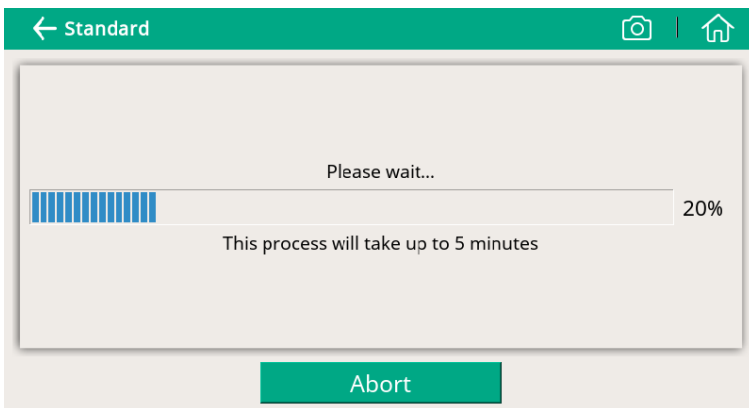

10. The system is performing the self-calibration and cleaning the internal sensor components. After cleaning and calibration, the measurement starts automatically.

The following 3 steps only apply if you select **Yes** for the isokinetic sampling device; otherwise skip the next 3 steps.

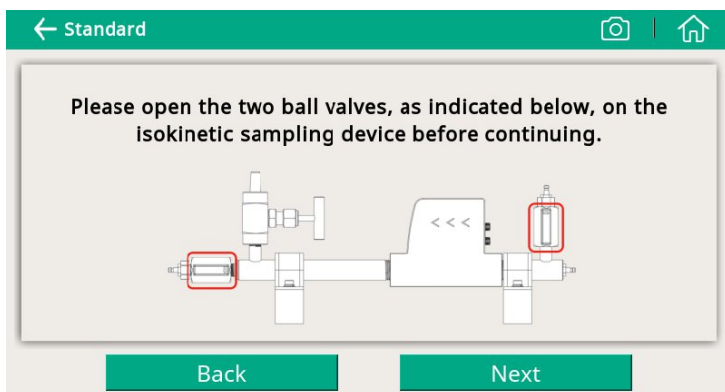

1. Follow the onscreen instructions to proceed.

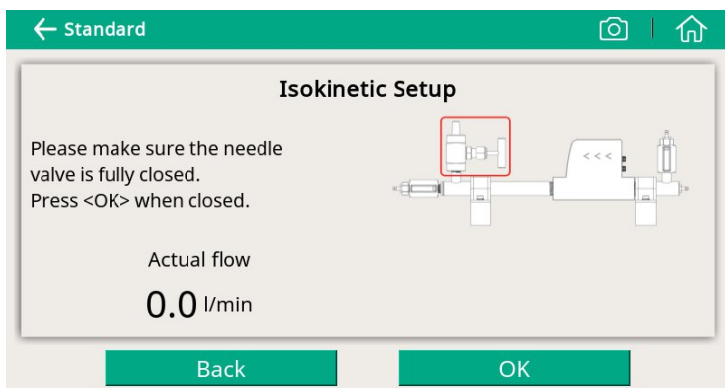

2. Perform Isokinetic Setup as instructed on the screen.

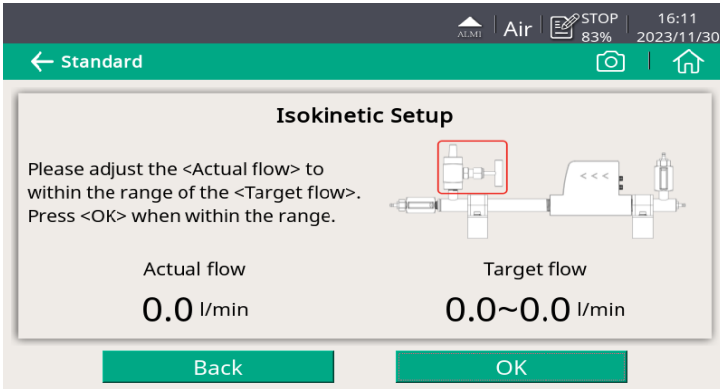

3. Now the isokinetic sampling device is well set up and starts to work. Clicking **OK** go to the step 9 System Preparation.

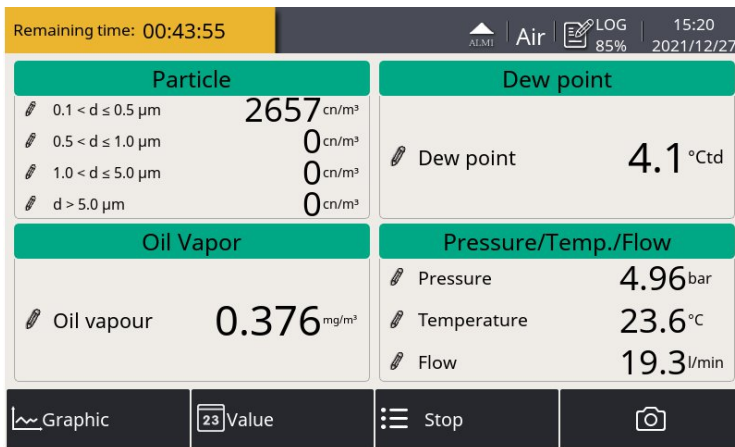

During the measurement, you can see the Data logger status icon on the status bar switched from STOP to LOG. The remaining time is displayed in the upper left corner. Please wait until the system complete the measurement.

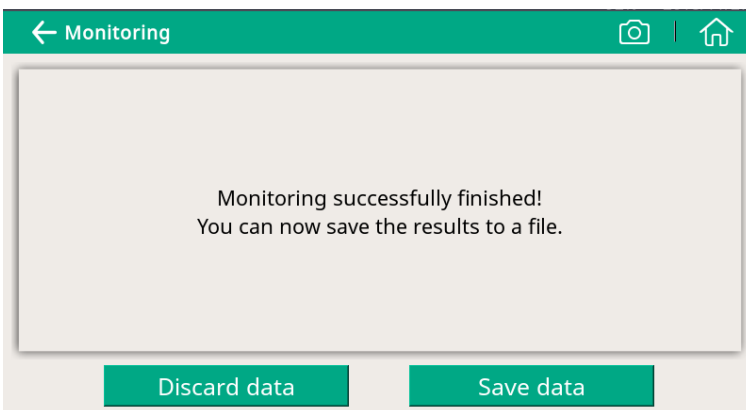

When the measurement is successfully completed, the screen on the left appears. Choose to discard or save the measurement data as needed.

10.2 Reports for guided measurements

After performing guided measurements, you can view and manage measurement files through **Guided Measurement > Report Manager**.

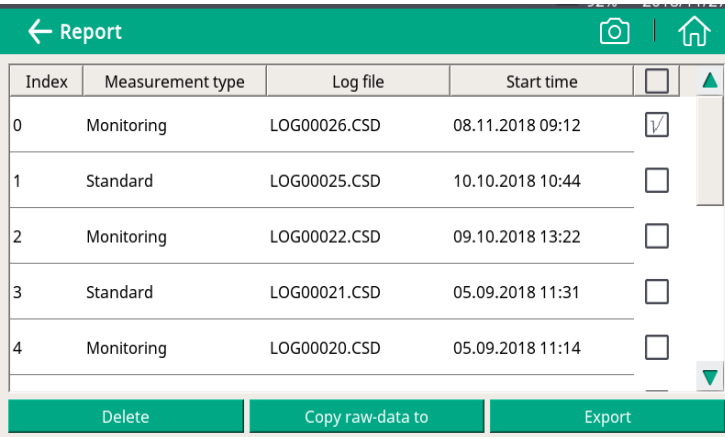

Index	Measurement type	Log file	Start time	<input type="checkbox"/>
0	Monitoring	LOG00026.CSD	08.11.2018 09:12	<input checked="" type="checkbox"/>
1	Standard	LOG00025.CSD	10.10.2018 10:44	<input type="checkbox"/>
2	Monitoring	LOG00022.CSD	09.10.2018 13:22	<input type="checkbox"/>
3	Standard	LOG00021.CSD	05.09.2018 11:31	<input type="checkbox"/>
4	Monitoring	LOG00020.CSD	05.09.2018 11:14	<input type="checkbox"/>

Buttons: Delete, Copy raw-data to, Export

- To view the measurement results, click on the file (not the check box on the right). A window appears showing the PDF for your preview.
- To copy, export or delete files, select the file check boxes, and then click the corresponding button at the bottom.

10.3 Export PDF reports

The S600 offers multiple export options for PDF reports. You can export by either of the following ways:

- Export to a USB stick through the Micro USB port on the front panel of the S600.
- Export to a PC via the S4A software.

10.3.1 Export to USB stick via the USB port



1. Insert the USB stick to the USB port on the front panel of the S600.

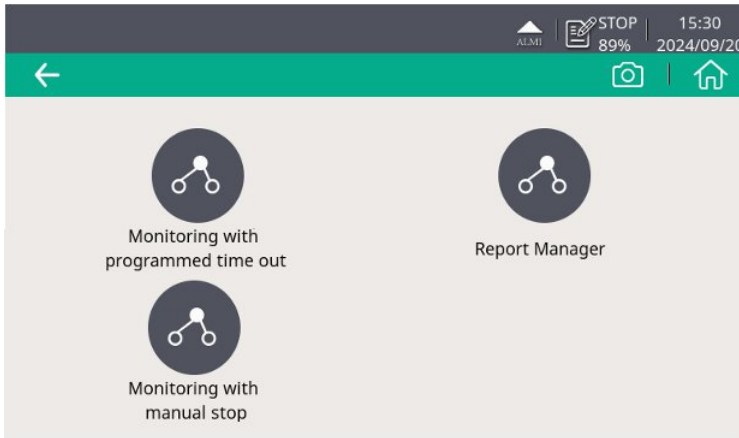

2. Click **Menu > Guided Measurement > Report Manager** to enter the Report Manager page.

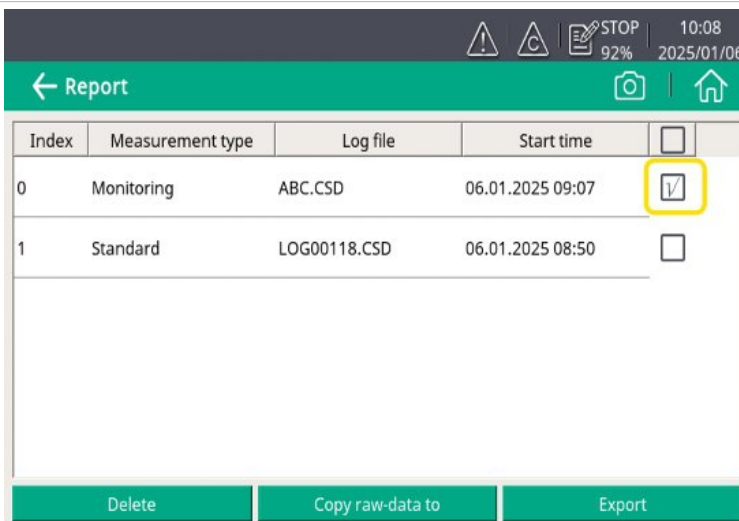

3. Click the checkbox to the right of the file you want to export, and three buttons will appear at the bottom of the screen.

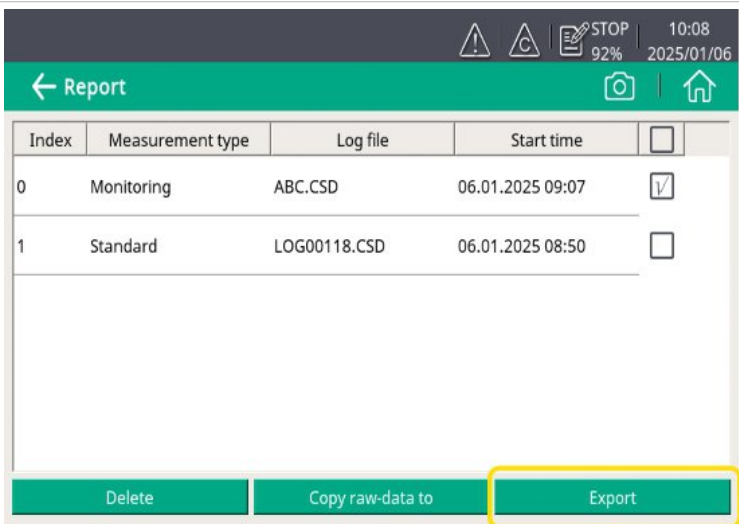

4. Click **Export** button.

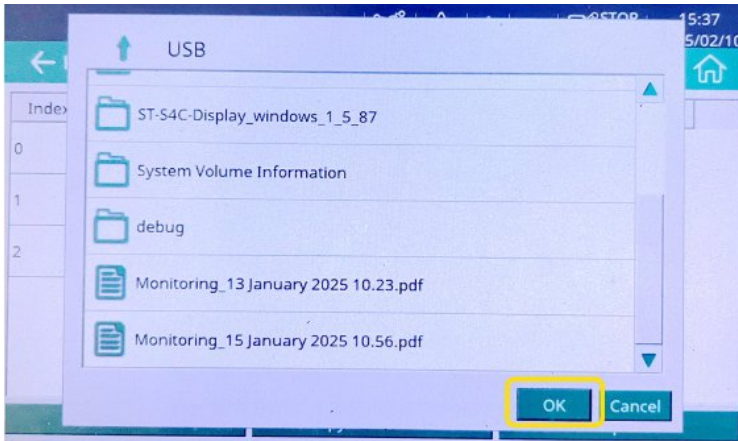

5. A pop up window appears. Select the desired save location and click **OK**.

Then the PDF report is exported to the USB stick.

- The PDF report on the USB stick can be opened on a PC.
- Click **Copy raw data to** button to export the log file.

10.3.2 Export via the S4A software

When exporting PDF reports to a PC using the S4A software, you need to connect the S600 to the PC by either of the following ways: via the USB port, via Ethernet, or via 4G remote communication.

10.3.2.1 Via USB port



Connect the S600 to the PC via the Micro USB port on the front panel of the S600.



You need to prepare a cable with one end Micro USB and the other end USB Type-A.

10.3.2.2 Via Ethernet connection

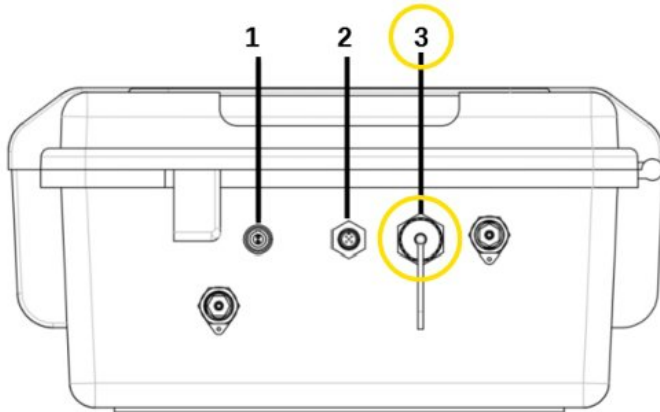

1. Connect the standard LAN cable to the RJ45 port on the right panel of the S600 (Connector 3).

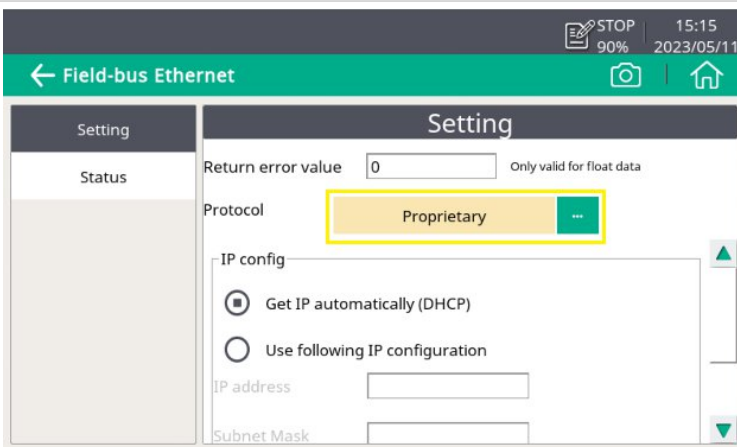

2. Click **Menu > Communication > Field-bus Ethernet > Setting** to select the **Proprietary** protocol.
 - Click **Settings** to set an IP address manually.
 - or
 - Set the IP via the DHCP.

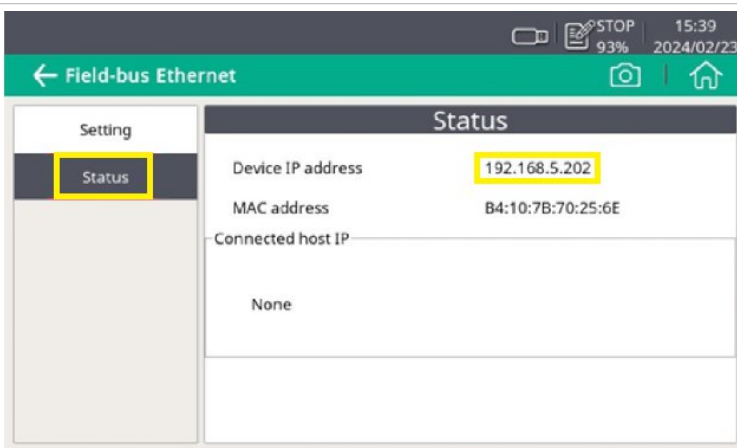

3. View the IP address via **Menu > Communication > Field-bus Ethernet > Status**.

Note: The PC and the S600 must be in the same area network and share the same address segment. VLANs are not possible. Example is shown as below.

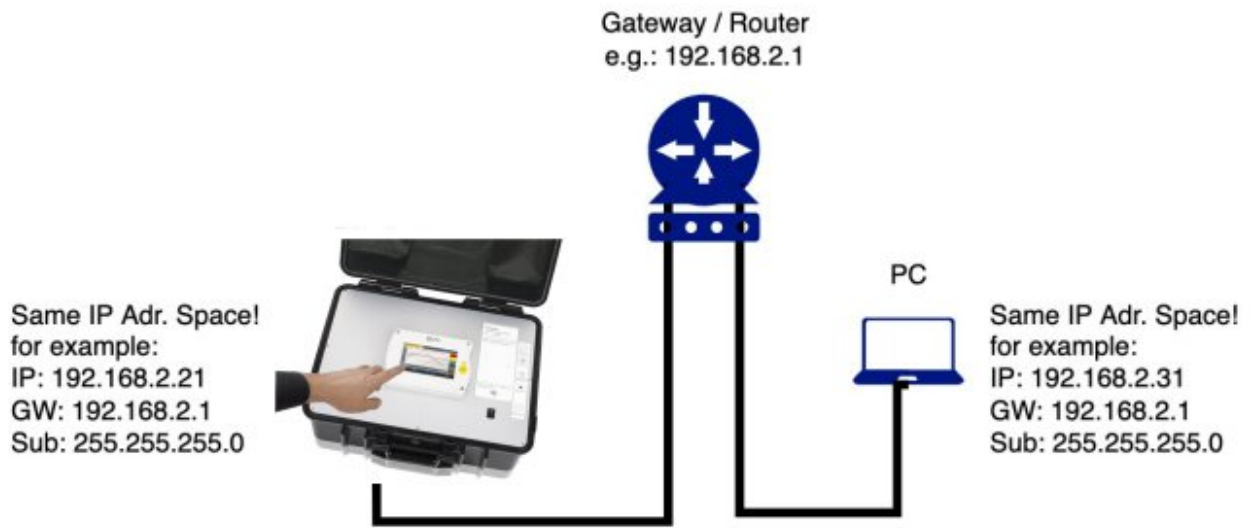

10.3.2.3 Via S4A remote communication connection



1. Turn off the S600.
2. Insert the 4G module.
3. Restart the boot power.

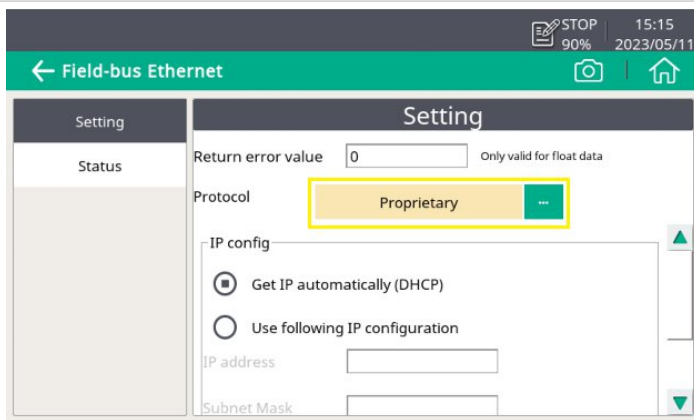

4. Click **Menu > Communication > Field-bus Ethernet > Setting** to select the **Proprietary** protocol.

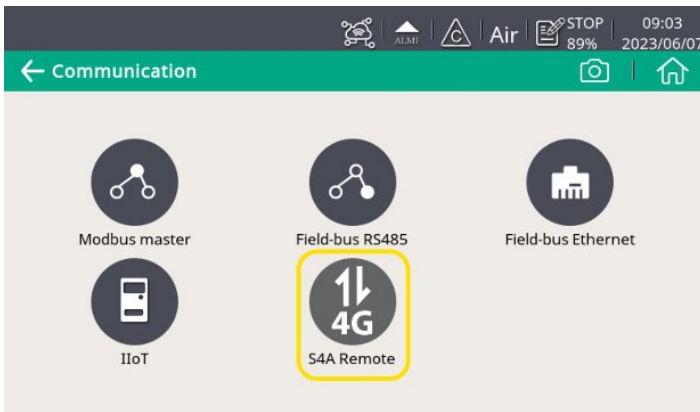

5. Click **Menu > Communication > S4A Remote Communication.**

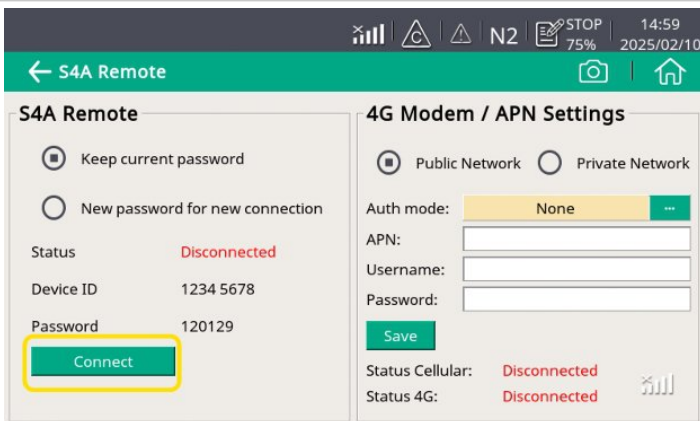

6. Click **Connect** button.

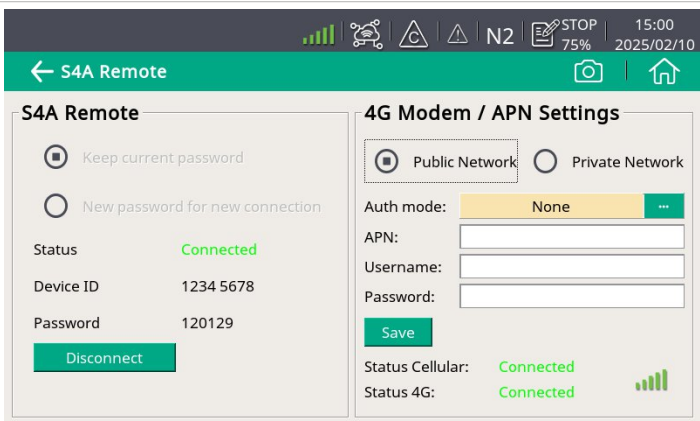

When the connected status is displayed, the remote connection has been established.

Note: Remote communication of the S4A is successfully established only when the 4G module is connected with both the cellular network and the 4G network.

10.3.2.4 Export PDF reports

- Download the S4A Software Version 1.4.7 or later and install it on your PC.
- Make sure your firewall does not block the S4A software required to connect to the S600.

After the S4A has been installed and started, follow steps below to export PDF reports.

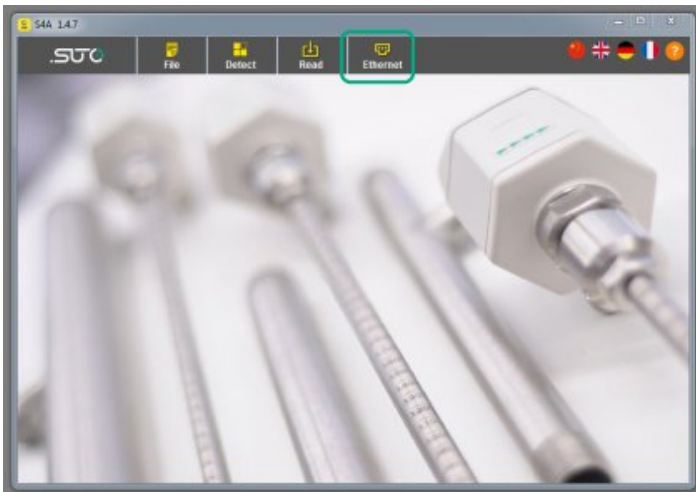

1. Check the connection modes:
 - For USB connection: set it to **USB**.
 - For Ethernet and S4A remote communication: set it to **Ethernet**.

You can change the mode by clicking this mode button.

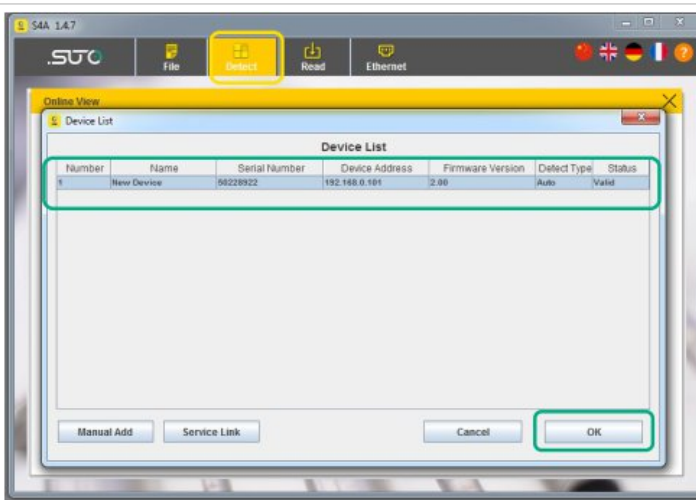

2. Click **Detect** button. A new pop-up window appears showing the automatically connected S600.

3. Select the S600 by clicking the line and the click **OK**.

Note: If the S600 is not shown, check your connection and make sure that it is reachable.

- For Ethernet connection, you can add the device manually by clicking **Manual Add**.
- For S4A remote communication, you can add the device manually by **Service link**.



4. Live readings from the S600 are displayed.

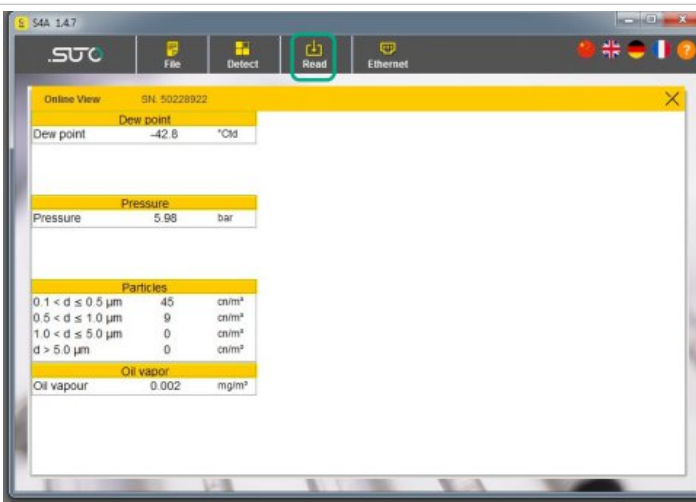

5. Click the **Read** button in the menu bar.

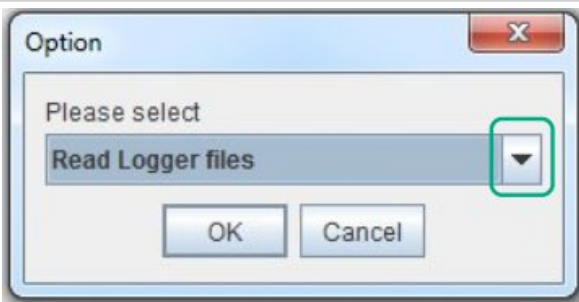

6. A pop-up windows appears.

7. Click  to open the drop-down menu.

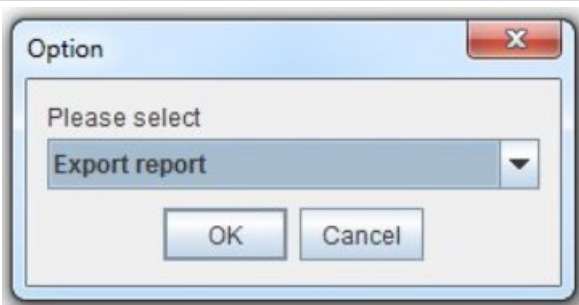

8. Select **Export report** and click **OK**.



9. A new pop-up windows shows the available files on the S600 that can be exported as PDF reports.

Note: If no PDF report is shown, perform a guided measurement in the S600 to generate measurement data.

10. Select the measurement file from which you want to download the PDF reports.

11. Press **OK**.

12. Select a location to save the PDF report.

Note: Do not change the folder name in the line, otherwise the PDF will not be exported.

13. Click **Save** button after you select the correct folder.

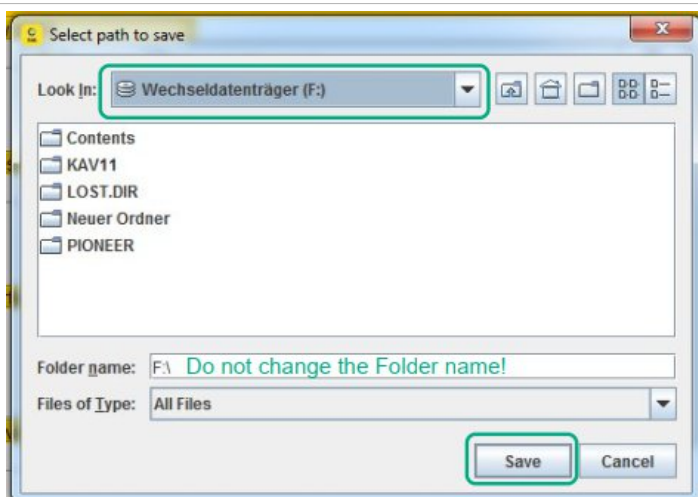

Done!

Your PDF report is now saved in the selected folder.

11 Optional accessories

To purchase optional accessories, please contact the manufacturer or your local dealer:

- Isokinetic sampling device, for particle sampling according to ISO 8573
- Teflon hoses and sorts of adapters
- USB 4G dongle, including S4A software (P/N: A1670)

12 Maintenance

Use a moist fabric to clean the device. For the use in GMP areas, the device must be disinfected through wipe disinfection. For more information, please contact the manufacturer or your local dealer.



ATTENTION!

Please dry the device after cleaning using a clean and dry fabric. Always take care, that the fabric for cleaning is not wet because water could get into the device and lead to damage.

13 Calibration

The S600 unit is calibrated ex work. The exact calibration date is printed on the certificate which is supplied together with the unit. The accuracy of the unit is regulated by the onsite conditions, and parameters like high oil, high humidity or other impurities can affect the calibration and furthermore the accuracy. However it is recommended to calibrate the instrument at least once per year. The calibration is excluded from the instruments warranty. For this please contact the manufacturer.



ATTENTION!

Please save all your measurement data on an external device before returning the instrument to calibration and service. It might be necessary to reset the displays storage during calibration and service.

14 Disposal or waste



Electronic devices are recyclable material and do not belong in the household waste.

The sensor, the accessories and its packing must be disposed according to your local statutory requirements.

The dispose can also be carried by the manufacturer of the product, for this please contact the manufacturer.

15 Warranty

Please find the warranty as a separated warranty card included with the instrument delivery.

The warranty does not cover any wear parts or consumables, therefore the UV lamp with limited lifetime as well as the internal filter are not covered by the warranty.

16 Appendix - Modbus Interface

The default settings of the Modbus interface are as follows:

Mode : TCP
 DHCP : Yes
 MAC : Set ex-factory
 IP address : Dynamic or Static
 Subnet : Dynamic or Static
 Gateway : Dynamic or Static
 Timeout : ≥ 200 ms

Response message that the device returns to the master:

- Function code: 03

The information of the byte order is shown in the table below:

Byte Order	Sequence				Data Type
	1st	2nd	3rd	4th	
1-0-3-2	Byte 1 (MMMMMMMM*)	Byte 0 (MMMMMMMM *)	Byte 3 (SEEEEEEE)	Byte 2 (EMMMMMMM *)	FLOAT
1-0-3-2	Byte 1	Byte 0 LSB	Byte 3 MSB	Byte 2	UINT32 INT32
1-0	Byte 1 MSB	Byte 0 LSB	---	---	UINT16 INT16
1-0	Byte 1 XXX *	Byte 0 DATA	---	---	UINT8 INT8

* S: Sign, E: Exponent, M: Mantissa, XXX: no value

Explanations of MSB and LSB

- MSB** MSB refers to Most Significant Byte first, which follows the Big-Endian byte order.
For example, if the main system follows the MSB first order:
When the 4-byte floating number, in the order of Byte1-Byte0-Byte3-Byte2, is received from the slave (sensor), the master must change the byte order to Byte3-Byte2-Byte1-Byte0 for the correct display of the value.
- LSB** LSB refers to Least Significant Byte first, which follows the Little-Endian byte order.
For example, if the main system follows the LSB first order:
When the 4-byte floating number, in the order of Byte1-Byte0-Byte3-Byte2, is received from the slave (sensor), the master must change the byte order to Byte0-Byte1-Byte2-Byte3 for the correct display of the value.

The following table lists specifications of the Modbus output channels in this device.

Sensor Description	Channel Description	Holding register	Data type	No. of byte	Unit	Resolution	R/W
Dew point sensor	Temperature	2	FLOAT_L	4	°C	0.1	R
	Dew point	4	FLOAT_L	4	°C Td	0.1	R
	Serial number	10	UINT32_L	4		1	R
Particle counter	0.1 < d ≤ 0.5 um	20	FLOAT_L	4	cn/m ³	1	R
	0.5 < d ≤ 1.0 um	22	FLOAT_L	4	cn/m ³	1	R
	1.0 < d ≤ 5.0 um	24	FLOAT_L	4	cn/m ³	1	R
	d > 0.5 um	28	FLOAT_L	4	cn/m ³	1	R
	Serial number	30	UINT32_L	4		1	R
Oil vapor sensor	Oil vapor	40	FLOAT_L	4	mg/m ³	0.001	R
	Pressure	42	FLOAT_L	4	bar	0.01	R
	Serial number	48	UINT32_L	4		1	R
Display unit	Serial number	60	UINT32_L	4		1	R
ISD	Flow	70	FLOAT_L	4	l/min	0.1	R

SUTO iTEC GmbH

Grißheimer Weg 21
D-79423 Heitersheim
Germany

Tel: +49 (0) 7634 50488 00
Email: sales@suto-itec.com
Website: www.suto-itec.com

SUTO iTEC (ASIA) Co., Ltd.

Room 10, 6/F, Block B, Cambridge Plaza
188 San Wan Road, Sheung Shui, N.T.
Hong Kong

Tel: +852 2328 9782
Email: sales.asia@suto-itec.com
Website: www.suto-itec.com

SUTO iTEC Inc.

5460 33rd St SE
Grand Rapids, MI 49512
USA

Tel: +1 (616) 800-7886
Email: sales.us@suto-itec.com
Website: www.suto-itec.com