

## Instruction and Operation Manual

# S111

## Three-Phase Multi-Functional Smart Meter



Dear Customer,

Thank you for choosing our product.

The operating instructions must be read in full and carefully observed before starting up the device. The manufacturer cannot be held liable for any damage which occurs as a result of non-observance or non-compliance with this manual.

Should the device be tampered with in any manner other than a procedure which is described and specified in the manual, the warranty is canceled and the manufacturer is exempt from liability.

The device is destined exclusively for the described application.

SUTO offers no guarantee for the suitability for any other purpose. SUTO is also not liable for consequential damage resulting from the delivery, capability or use of this device.

Revision: 2025-1-1



Last modifications: March, 2025

## Table of contents

1 Safety instructions.....	4
2 Registered Trademarks.....	5
3 Product Description.....	6
4 Technical Data.....	7
4.1 General.....	7
4.2 Display Data.....	8
4.3 Accuracy and Certification.....	10
5 Connection.....	12
5.1 Power Supply.....	13
5.2 Voltage and Current Input.....	13
5.3 RS-485.....	15
6 Operation and Interface Display.....	15
6.1 Key Function Display Description.....	15
6.2 Meter Start Interface.....	16
6.3 Meter Display Mode Switching.....	16
6.4 Measure Menu Interface.....	17
6.4.1 Measure Menu - Instantaneous Value Interface.....	18
6.4.2 Measure Menu - Energy Interface.....	19
6.4.3 Measure Menu - Harmonics Interface.....	20
6.4.4 Measure Menu - Phasor Diagram Interface.....	21
6.4.5 Measure Menu - Demand Interface.....	22
6.4.6 Measure Menu - Unbalance Interface.....	22
6.4.7 Measure Menu - Max.&Min. Interface.....	23
6.5 Settings Menu Interface.....	24
6.5.1 Settings Menu - Power Grid Interface.....	25
6.5.2 Settings Menu - Current Sensor Interface.....	26
6.5.3 Settings Menu - Tariff Interface.....	28
6.5.4 Settings Menu - Demand Interface.....	29
6.5.5 Settings Menu - Communication Interface.....	30
6.5.6 Settings Menu - HMI Interface.....	31
6.5.7 Settings Menu - Password Interface.....	32
6.6 Reset Menu Interface.....	33
6.7 Device Information Menu Interface.....	34
7 Modbus Communication.....	35
8 Maintenance.....	35
9 Disposal or Waste.....	35

## 1 Safety instructions

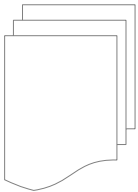

**Please check if this instruction manual matches with the product type.**

Please observe all notes and instructions indicated in this manual. It contains essential information which have to be observed before and during installation, operation and maintenance. Therefore this instruction manual has to be read carefully by the technician as well as by the responsible user / qualified personnel.

This instruction manual has to be available at the operation site of the power meter at any time. In case of any obscurities or questions, regarding this manual or the product, please contact the manufacturer.

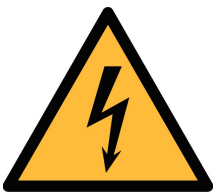

### **WARNING!**

#### **Dangerous voltage levels!**

**Any contact with energized parts of the product, may lead to an electrical shock which can lead to serious injuries or even death!**

- Consider all regulations for electrical installations.
- The system must be disconnected from any power supply during maintenance work.
- Any electrical work on the system is only allowed by authorized qualified personal.



### **ATTENTION!**

#### **Permitted operating parameters!**

**Observe the permitted operating parameters, any operation exceeding this parameters can lead to malfunctions and may lead to damage on the instrument or the system.**

- Do not exceed the permitted operating parameters.
- Make sure the product is operated in its permitted limitations.
- Do not exceed or undercut the permitted storage and operation temperature.
- The product should be maintained frequently, at least annually.

## General safety instructions

- It is not allowed to use the product in explosive areas.
- Please observe the national regulations before/during installation and operation.

## Remarks

- It is not allowed to disassemble the product.



### **ATTENTION!**

**Measurement values can be affected by malfunction!  
The product must be installed properly and frequently maintained, otherwise it may lead to wrong measurement values, which can lead to wrong results.**

## Storage and transportation

- Make sure that the transportation temperature of device is between  $-30^{\circ}\text{C}$  ...  $+70^{\circ}\text{C}$ .
- For transportation it is recommended to use the packaging which comes with the device.
- Please make sure that the storage temperature of the device is between  $-40^{\circ}\text{C}$  ...  $+85^{\circ}\text{C}$ .
- Avoid direct UV and solar radiation during storage.
- For the storage the humidity has to be  $<90\%$ , no condensation.

## 2 Registered Trademarks

SUTO®

Registered trademark of SUTO iTEC

MODBUS®

Registered trademark of the Modbus Organization, Hopkinton, USA

### 3 Product Description

The S111 is a DIN-Rail three-phase multi-functional smart meter that supports external connections, including open-type Rogowski coil and voltage type CT. The device enables non-dismantling wire test, streamlines test steps, reduces construction cost, and offers enhanced convenience for engineering tests, inspections, and maintenance of distribution systems.

The S111 supports single-phase and three-phase systems. It can measure a range of electrical parameters, including current, voltage, power factor, harmonics, power, energy, and other electrical parameters of L1, L2, and L3. The standard RS485 communication interface is compatible with various configuration systems via the standard Modbus/RTU protocol.

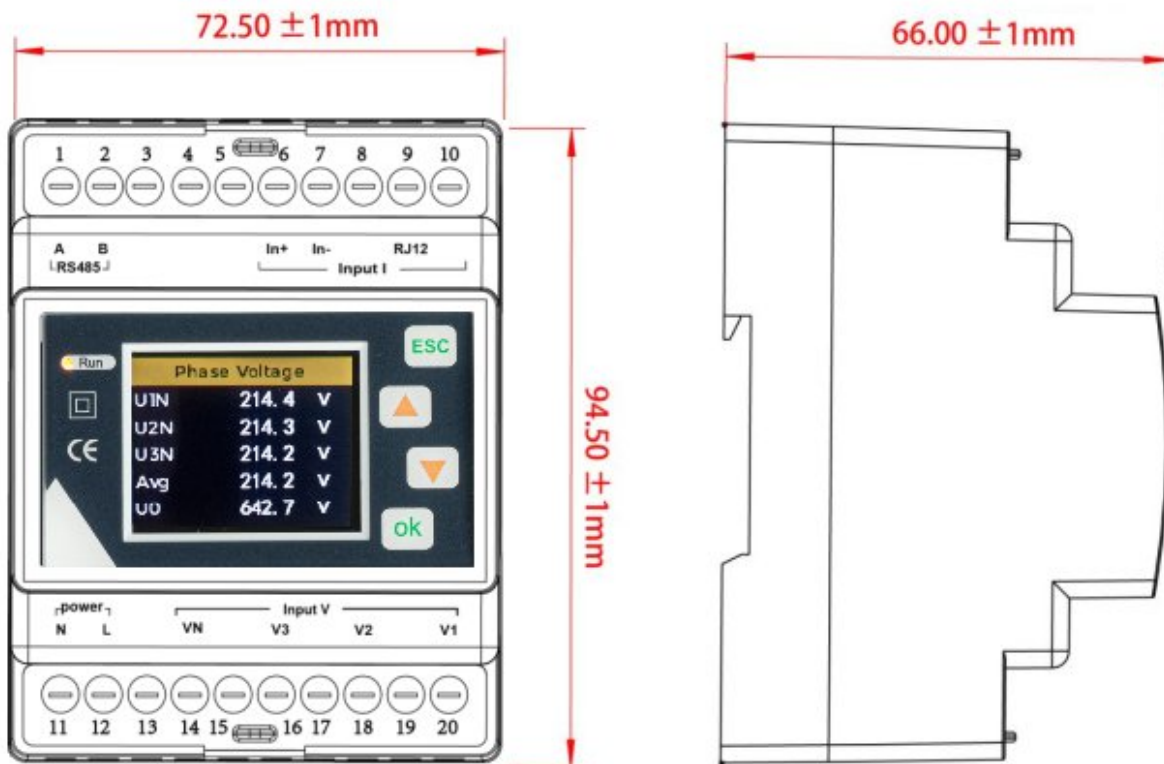

Dimensional drawing

## 4 Technical Data

### 4.1 General

<b>Description</b>	
Type	DIN rail
Model	S111
Current sensor type	Rogowski coil Voltage-output current clamp
Advantage	Suitable for wide current range, no dismantling measurement
Wiring system	3P4W 3CT, 3P3W 3CT, 1P2W_1CT
Application field	Power analysis Tariff meter
Display screen	1.77 inch TFT screen display
Weight	259 g
Dimension	L*W*D: 9.45*7.25*6.6 cm
Color	White
<b>Current</b>	
Channel input voltage range	0 ~ 900 mVAC peak, 636 mV RMS
Measurement range	Different current sensors have different ranges
Rcoil	<a href="#">50mV/kA@50Hz(0-12000A)</a> , @60Hz(0-10000A) <a href="#">85mV/kA@50Hz(0-7000A)</a> , @60Hz(0-6000A) ...
VCT	0 ~ 99999 A
<b>Voltage</b>	
Channel input voltage range	0 ~ 720 VAC Phase Voltage
Maximum range	720 VAC Phase Voltage
<b>Communication</b>	
RS485 communication	One way RS485 communication interface Interface type: two wire half duplex Communication baudrate: 2400 bps ~ 38400 bps Protocol: Modbus/RTU

<b>Power supply</b>	
Power supply	24 VDC
Maximum power consumption	3.5 VA

## 4.2 Display Data

<b>Instantaneous value</b>	
Phase Voltage	U1, U2, U3, AVG
Line Voltage	U12, U23, U31, AVG
Current	I1, I2, I3, AVG, IN
Grid Frequency	F1, F2, F3, $\Sigma$
Power Factor PF	PF1, PF2, PF3, $\Sigma$
Fundamental power factor DPF	DPF1, DPF2, DPF3, $\Sigma$
Active power	P1, P2, P3, $\Sigma$
Reactive power	Q1, Q2, Q3, $\Sigma$
Apparent power	S1, S2, S3, $\Sigma$
<b>Energy</b>	
Active energy Pos.	EP1, EP2, EP3, $\Sigma$
Active Energy Neg.	EP1, EP2, EP3, $\Sigma$
Reactive Energy Pos.	EQ1, EQ2, EQ3, $\Sigma$
Reactive energy Neg.	EQ1, EQ2, EQ3, $\Sigma$
Apparent Energy	ES1, ES2, ES3, $\Sigma$
Tariff Energy	ET1, ET2, ET3, ET4, ET5, ET6
<b>Harmonics</b>	
Voltage Harmonics Distortion	THD (Total harmonic percentage), TOHD (Odd total harmonic percentage), TEHD (Even total harmonic percentage), phase L1.L2.L3 1-50th harmonic percentage, phase ABC 1-50th harmonic voltage value
Voltage Harmonic Value	



Current Harmonic Distortion	THD (Total harmonic percentage), TOHD (Odd total harmonic percentage), TEHD (Even total harmonic percentage), phase L1.L2.L3 - 50th harmonic percentage, phase ABC 1-50th harmonic current value
Current Harmonic Value	
<b>Phasor diagram</b>	
Phasor diagram	between voltage and current
Phase Sequence	voltage and current
Voltage Angle	U1, U2, U3
Current Angle	I1, I2, I3
UI Angle	UI1, UI2, UI3
<b>Demand</b>	
Demand	P, Q, S
Active power DMD Max.	P and Time
Reactive power DMD Max.	Q and Time
Apparent power DMD Max.	S and Time
<b>Unbalance</b>	
Voltage unbalance	Negative Sequence, zero Sequence
current unbalance	Negative Sequence, zero Sequence
<b>Max. &amp; Min.</b>	
Phase voltage	U1, U2, U3, AVG
Line Vvltage	U12, U23, U31, AVG
Current	I1, I2, I3, AVG, IN
Active power	P1, P2, P3, $\Sigma$
Reactive power	Q1, Q2, Q3, $\Sigma$
Apparent power	S1, S2, S3, $\Sigma$

### 4.3 Accuracy and Certification

<b>Measuring accuracy</b>	
Current measurement accuracy	0.1%+Accuracy of current sensor
Voltage measurement accuracy	±0.2% (60 V ~ 600 V AC) ±1% (other voltage except 60 V ~ 600 V AC)
Grid frequency	±0.01% (45 ~ 65 Hz)
Power factor	±0.005
Active and apparent power	IEC62053-22 level 0.5S
Reactive power	IEC62053-21 level 1S
Active energy	IEC62053-22 level 0.5S
Reactive energy	IEC62053-21 level 1S
<b>Environment condition</b>	
Operating temperature	-25°C ~ +60°C
Storage temperature	-40°C ~ +85°C
Humidity range	5 ~ 95% RH, 50°C (non-condensing)
Class of pollution	2
Over voltage capability	CAT III 1000V, It is suitable for distribution system below 277 / 480VAC
Insulation strength	IEC61010-1
Altitude	3000m Max
Antipollution level	IP20 (Meet the standard of IEC 60629)
Quality guarantee period	12 months
<b>EMC (electromagnetic compatibility)</b>	
Electrostatic discharge	Level IV (IEC61000-4-2)
Radiated immunity	Level III (IEC61000-4-3)
EFT Electrical fast burst immunity	Level IV (IEC61000-4-4)
Surge immunity	Level IV (IEC61000-4-5)
Conducted disturbance	Level III (IEC61000-4-6)

immunity	
Power frequency magnetic field immunity	0.5mT (IEC61000-4-8)
Conduction and radiation	Class B (EN55022 )
<b>Measurement standard</b>	
EN 62052-11, EN61557-12, EN 62053-21, EN 62053-22, EN 62053-23, EN 50470-1, EN 50470-3, EN 61010-1, EN 61010-2, EN 61010-031	

## 5 Connection

The meter is equipped with rich interfaces to realize different functions.

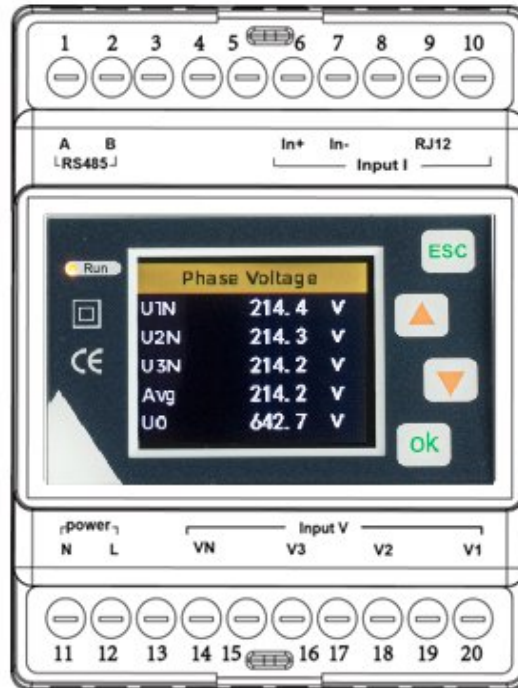

Point No.	Point name	Point function	Point type	Note
1	A	RS-485 communication A	RS-485	RS-485 communication
2	B	RS-485 communication B		
3	/	/	/	/
4	/	/	/	/
5	/	/	/	/
6	In+	Phase LN current input positive	Current input	Current channel
7	In-	Phase LN current input negative		
8	RJ-12	Phase L1, L2, L3 current input		
9				
10				
11	N	Power supply (-)	Power supply	18 ~ 36 VDC
12	L	Power supply (+)		
13	/	/	Voltage input	Measurement voltage input
14	Vn	LN-phase voltage input		

15	/	/	channel
16	V3	L3-phase voltage input	
17	/	/	
18	V2	L2-phase voltage input	
19	/	/	
20	V1	L1-phase voltage input	

## 5.1 Power Supply

The meter is designed to operate in external power supply mode, without internal direct power supply. The power supply voltage range is 18 ~ 36 VDC, with the maximum power consumption of 3.5 VA.

- Do not connect the meter with the cable live.
- Before connecting the power supply, make sure that the power supply voltage is within the specified range. Otherwise, the meter cannot function normally.

## 5.2 Voltage and Current Input

The S111 supports 2 kinds of wiring methods: 3P4W\_3CT, 3P3W\_3CT, and 1P2W\_1CT.

Before connecting the measurement wires, please correctly configure the wiring method of the meter.

- The actual wiring mode of the meter must be consistent with that of the internal configuration of the meter.
- The 3P4W\_3CT requires 3 current sensors, the N phase current is obtained by calculation.
- The 3P3W\_3CT requires 3 current sensors, the L2 phase current is measured by the sensors.
- The 1P2W\_1CT requires 1 current sensor.
- The phase sequence of voltage and current must follow the phase sequence of ABC, otherwise the meter will display the phase sequence error of voltage and current.
- When using the current sensor, the direction of the current arrow on the sensor must be consistent with the actual current flow direction, that is, the current arrow of the sensor points to the load end.

The S111 connection mode of voltage and current is as follows:

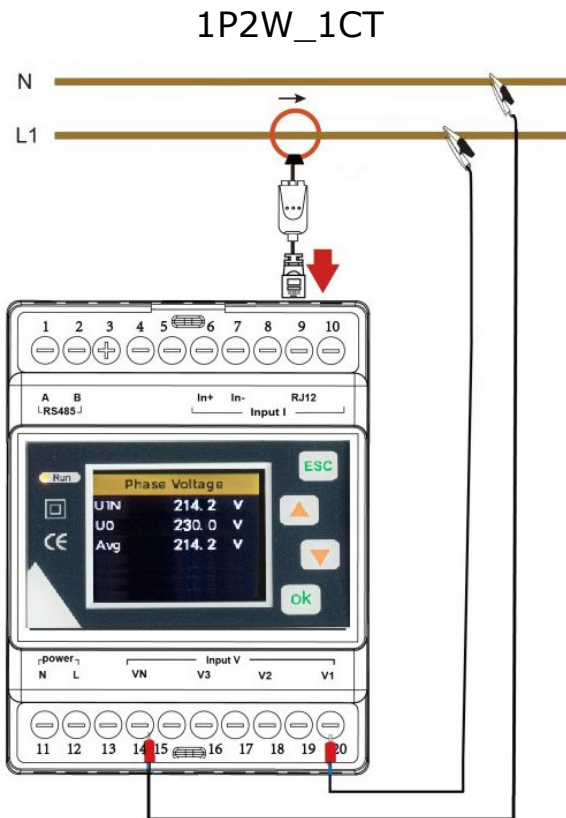
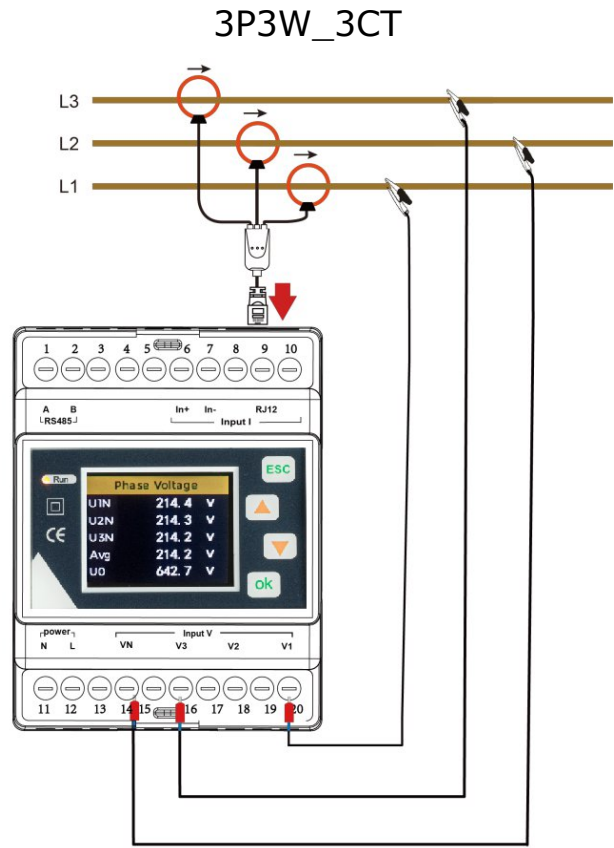
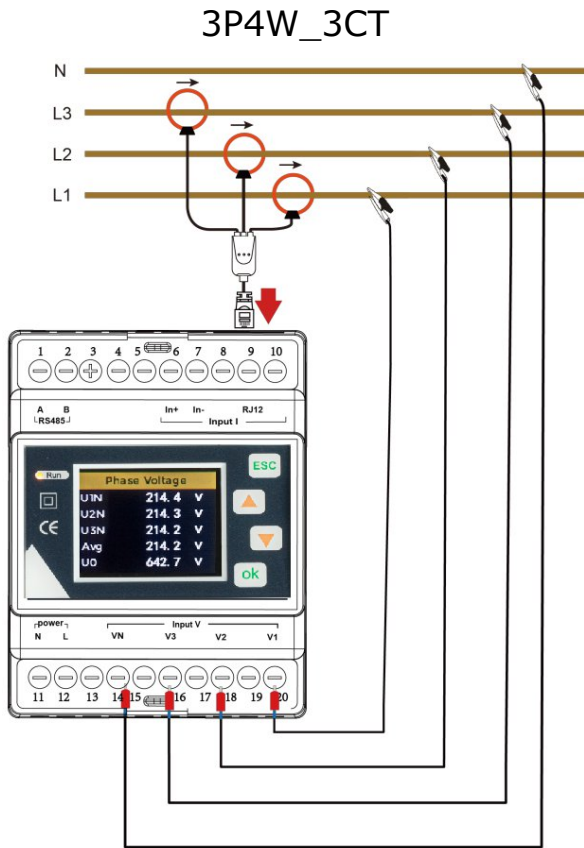

### 5.3 RS-485

The meter is equipped with a RS-485 communication interface, which supports Modbus/RTU protocol. The RS-485 communication port requires shielded twisted pair connection, which is connected in the form of daisy chain. In the case of long distance and high speed, a 120 Ω resistor must be parallel connected at both ends of the daisy chain.

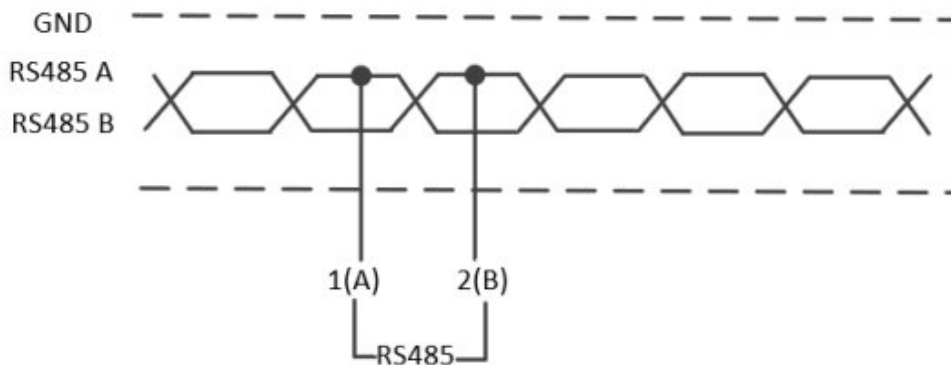

## 6 Operation and Interface Display

This section describes the display of the interface and key combination operation, as well as the configuration of the equipment.

The four buttons on the meter are shown below:



### 6.1 Key Function Display Description

Key	Description
	Return key: used to exit the current operation interface.
	Up key: used to switch the interface display and Long press to switch displacement.
	Down key: used to switch the interface display and Long press to switch displacement.
	Confirm key: used to confirm the operation and switch the numerical display when setting.

### 6.2 Meter Start Interface

After the meter is powered on and started, the interface below displays.

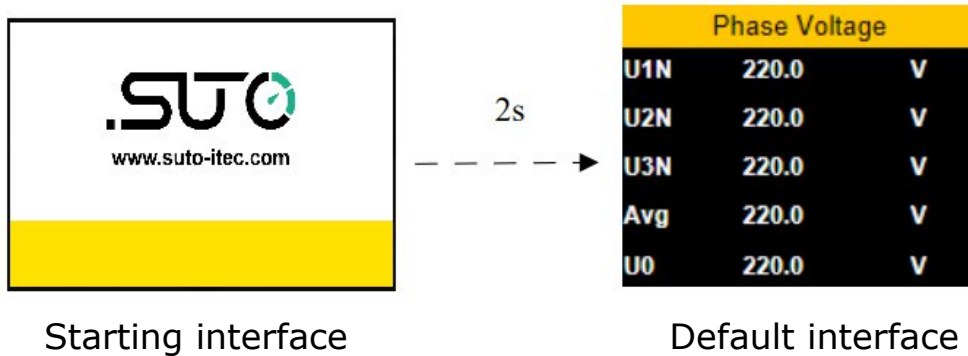

### 6.3 Meter Display Mode Switching

Under the main menu of the S111, the following four secondary menus are available: **Measure**, **Settings**, **Reset**, and **Device information**. Switching among menus is shown in the figure below:

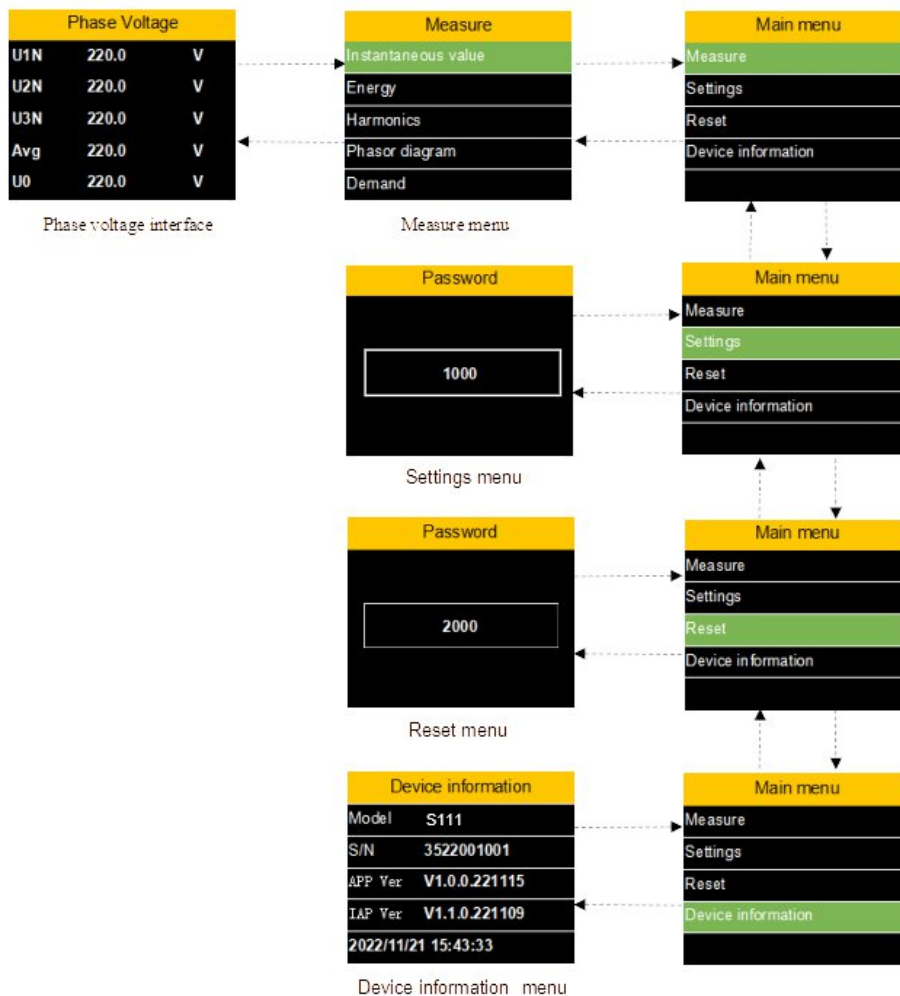



### 6.4 Measure Menu Interface

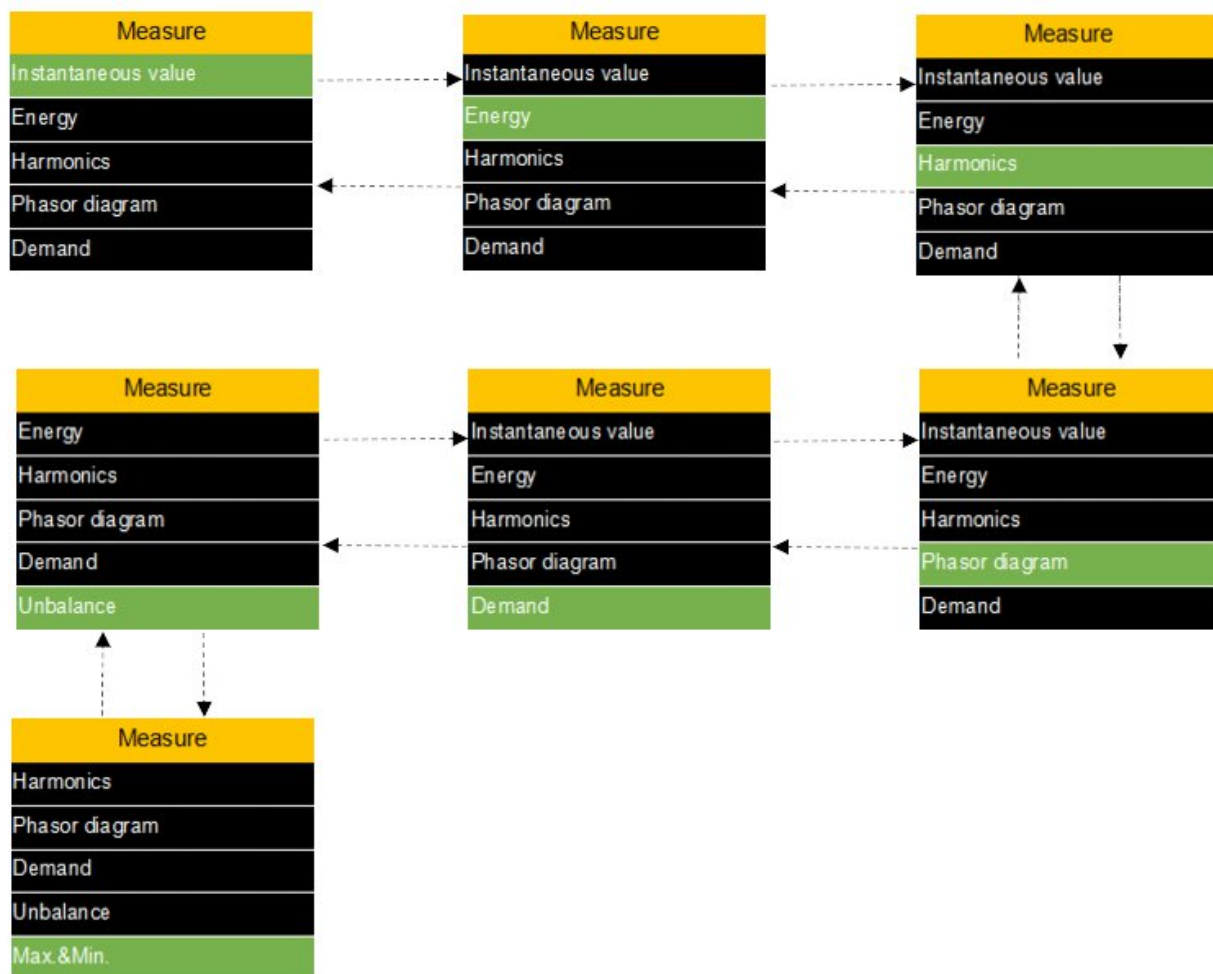

The **Measure** menu contains 7 sub-menus: **Instantaneous Value, Energy, Harmonics, Phase Diagram, Demand, unbalance, Max.&Min.**

Press or to switch the display of the interface.



### 6.4.1 Measure Menu - Instantaneous Value Interface

The **Instantaneous value** interface is used to display voltage, current, power, power factor, frequency, and other data.

Press  or  to switch the display of the interface.

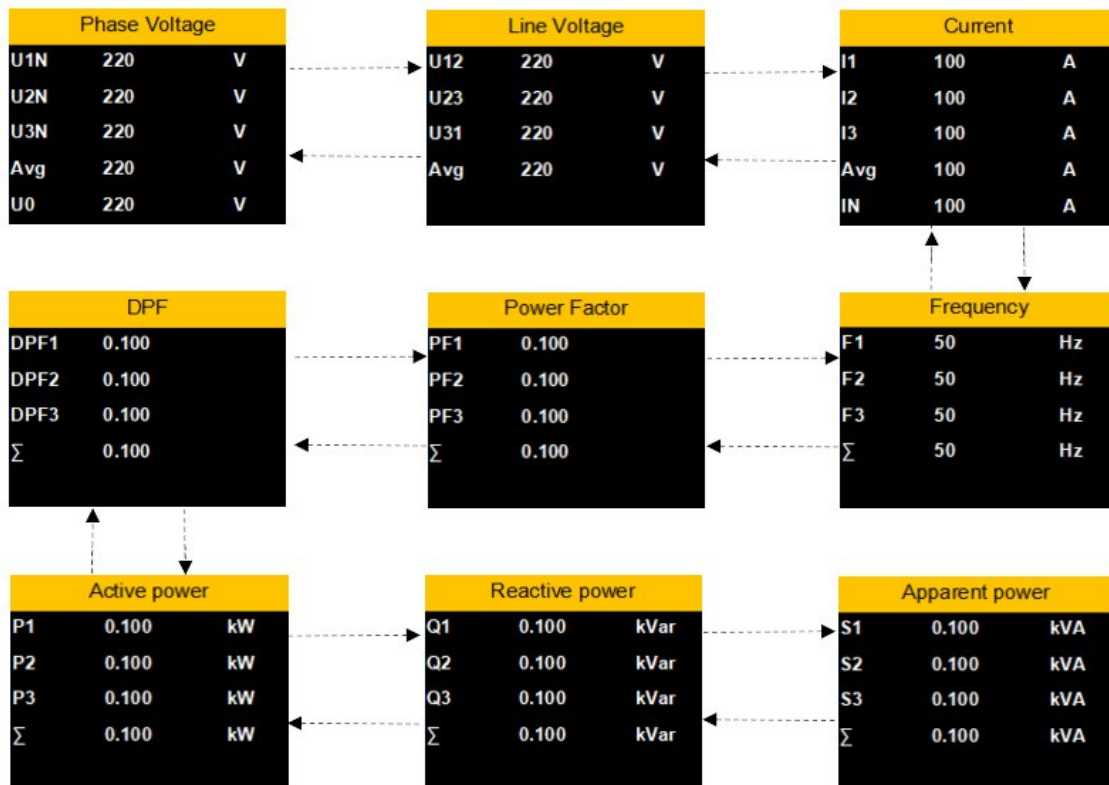

### 6.4.2 Measure Menu - Energy Interface

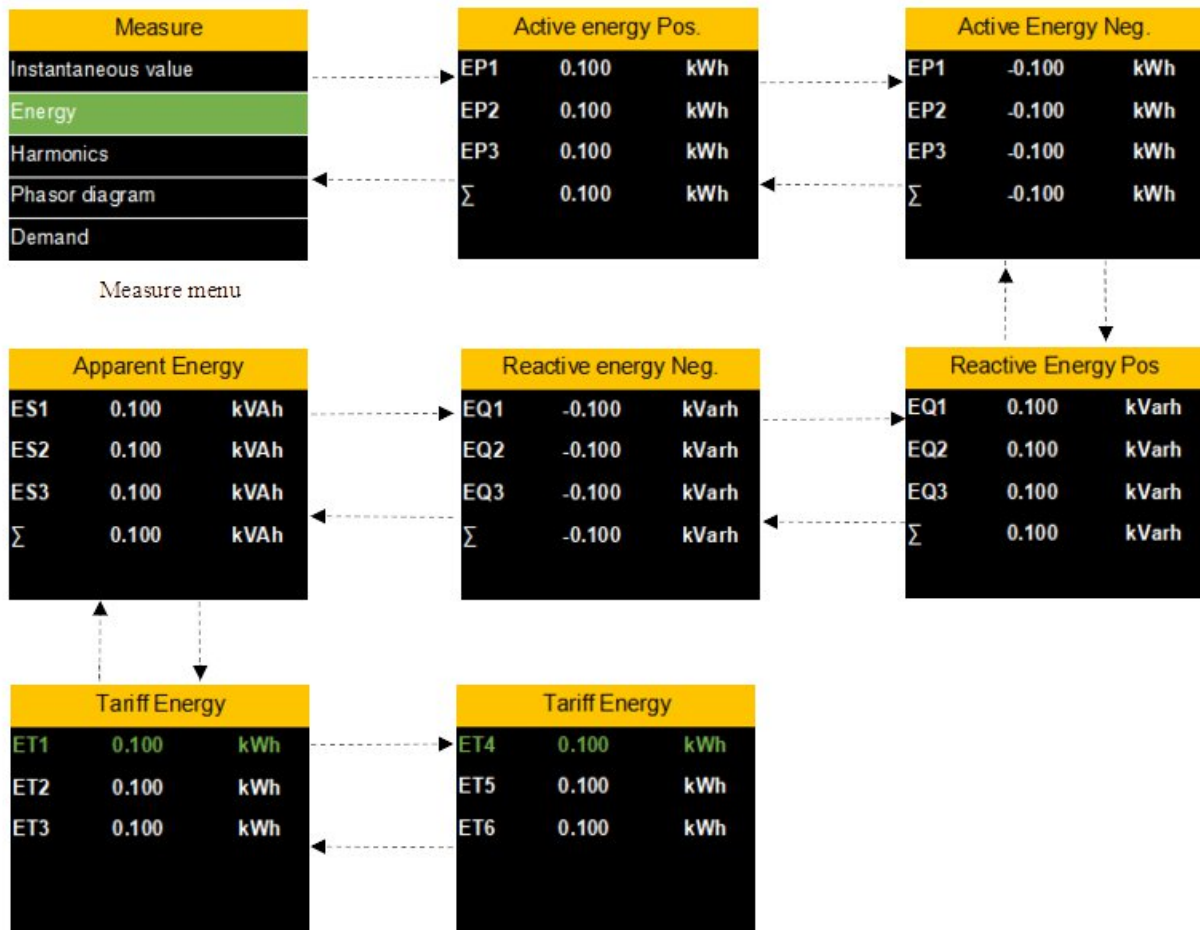

The **Energy** interface is used to display Active energy, Reactive energy, and Apparent energy.

Press or to switch the display of the interface.



### 6.4.3 Measure Menu - Harmonics Interface

The **Harmonics** interface is used to display Voltage harmonics, current harmonics, and other data.

Press  or  to switch the display of the interface.





### 6.4.4 Measure Menu - Phasor Diagram Interface

The **Phasor diagram** interface is used to display Phasor diagram, Phase Sequence, Angle, and other data.

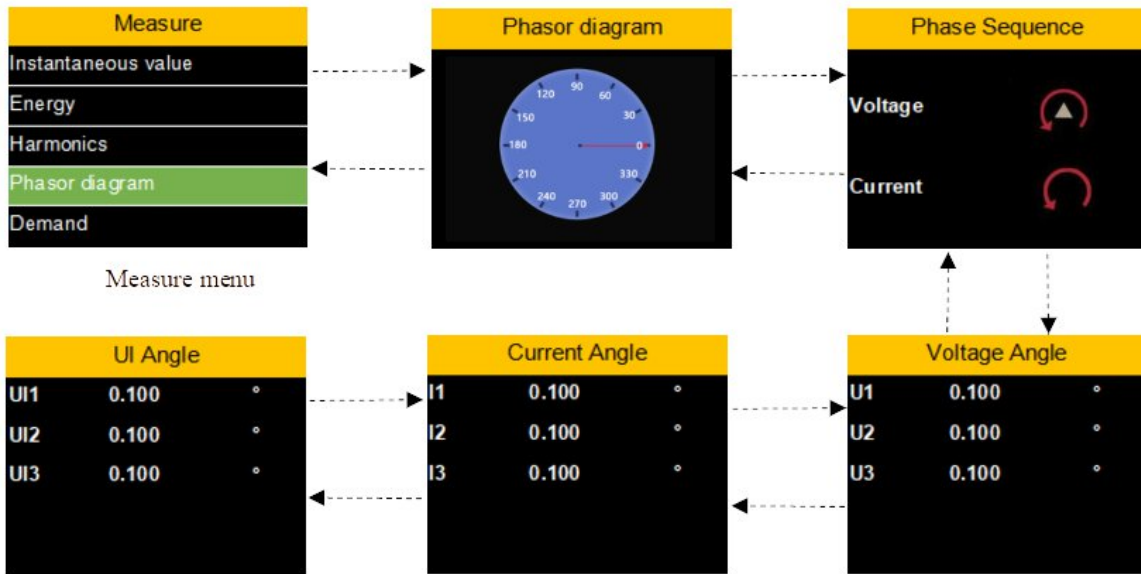
Press or to switch the display of the interface.



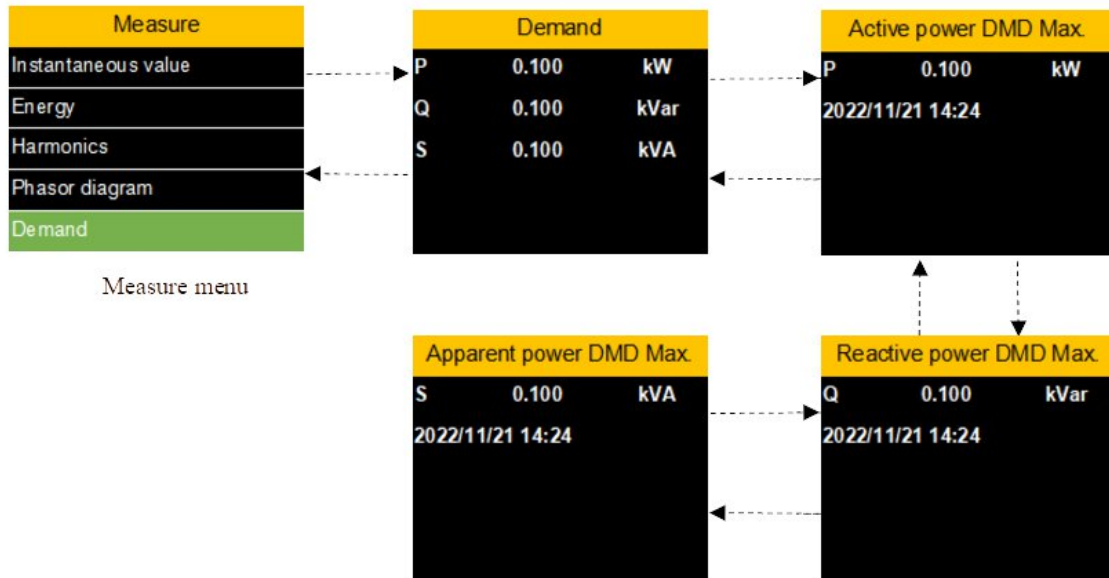

### 6.4.5 Measure Menu - Demand Interface

The **Demand** interface is used to display Active power, Reactive power, Apparent power DMD. Press  or  to switch the display of the interface.



### 6.4.6 Measure Menu - Unbalance Interface

The **Unbalance** interface is used to display Voltage unbalance, current unbalance. Press  or  to switch the display of the interface.

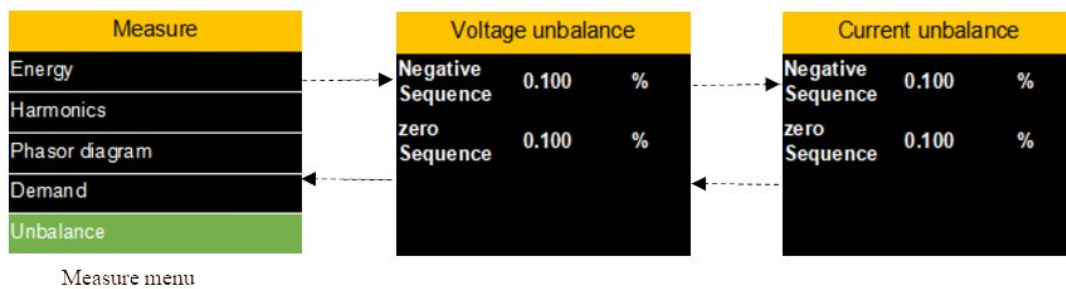

### 6.4.7 Measure Menu - Max.&Min. Interface

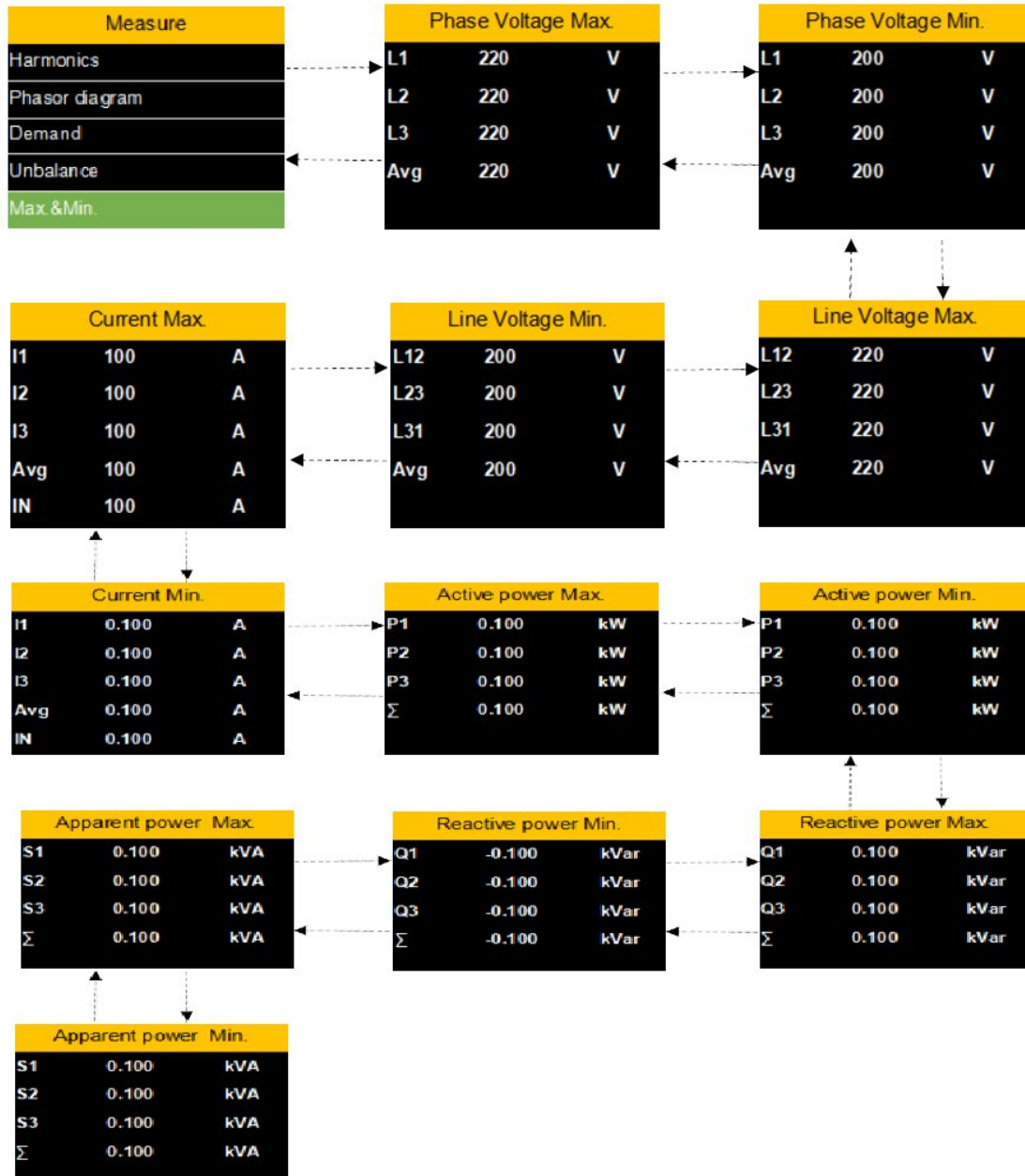

The **Max.&Min.** interface displays Voltage Max.&Min., current Max.&Min., and other data. Press or to switch the interface.





### 6.5 Settings Menu Interface

The **setting** menu is used for setting: Wire Type. Current sensor type and transformation ratio, voltage transformer transformation ratio, communication parameters, demand, backlight control, equipment time, password and other parameters.



Before entering the configuration page, you need to enter the configuration password (default 1000). Press **OK** Key to enter the

password; press  or  to modify the value size, and press and

hold  or  to switch displacement (the corresponding value will flash). Input the password correctly, and press OK Key to enter the configuration interface. If entering the wrong password, you will stay in the password input interface.

If you forget the configuration password, you can enter the last four digits of the device serial number to enter the configuration interface.



Press  or  to switch the display of the interface. Press **OK** to enter parameter configuration.

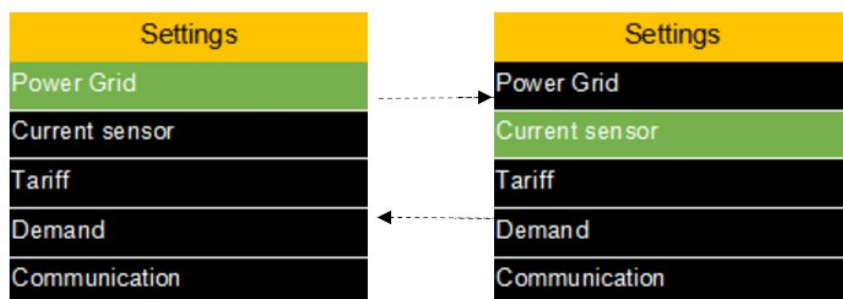



### 6.5.1 Settings Menu - Power Grid Interface

Press **OK** to enter the power grid setting. Press or to modify the value. After the data modification is completed, a prompt appears asking whether you wish to save the changes. Press **OK** or **ESC** key to save or not save the changes.

The power grid sub-menu can set the Wire Type, Frequency, Nominal Voltage, VT ratio, and CT ratio.

Wire Type: 3P4W 3CT, 3P3W 3CT, 1P2W 1CT

Frequency: 50\60



Nominal Voltage: 00001 - 65535

VT ratio: 1~10000, (primary end voltage / secondary end voltage) \*10000. Unit V/V

CT ratio: 1~10000, (primary end current / secondary end current) \*10000. Unit A/A



### 6.5.2 Settings Menu - Current Sensor Interface

Press **OK** to enter the Current sensor setting. Press  or  to modify the value. After the data modification is completed, a prompt appears asking whether you wish to save the changes. Press **OK** or **ESC** key to save or not save the changes.

The **Current sensor** sub-menu can set Phase Type, Sensor Type, Pri[A], Sec[mV], Nominal Current[A].

Phase Type: I1,I2,I3 \ In

Sensor Type: Rcoil \ VCT

Pri[A]: 1 - 999999



Sec[mV] (@50Hz/@60Hz): 1 - 99999

Nominal Current [A]: 1-99999

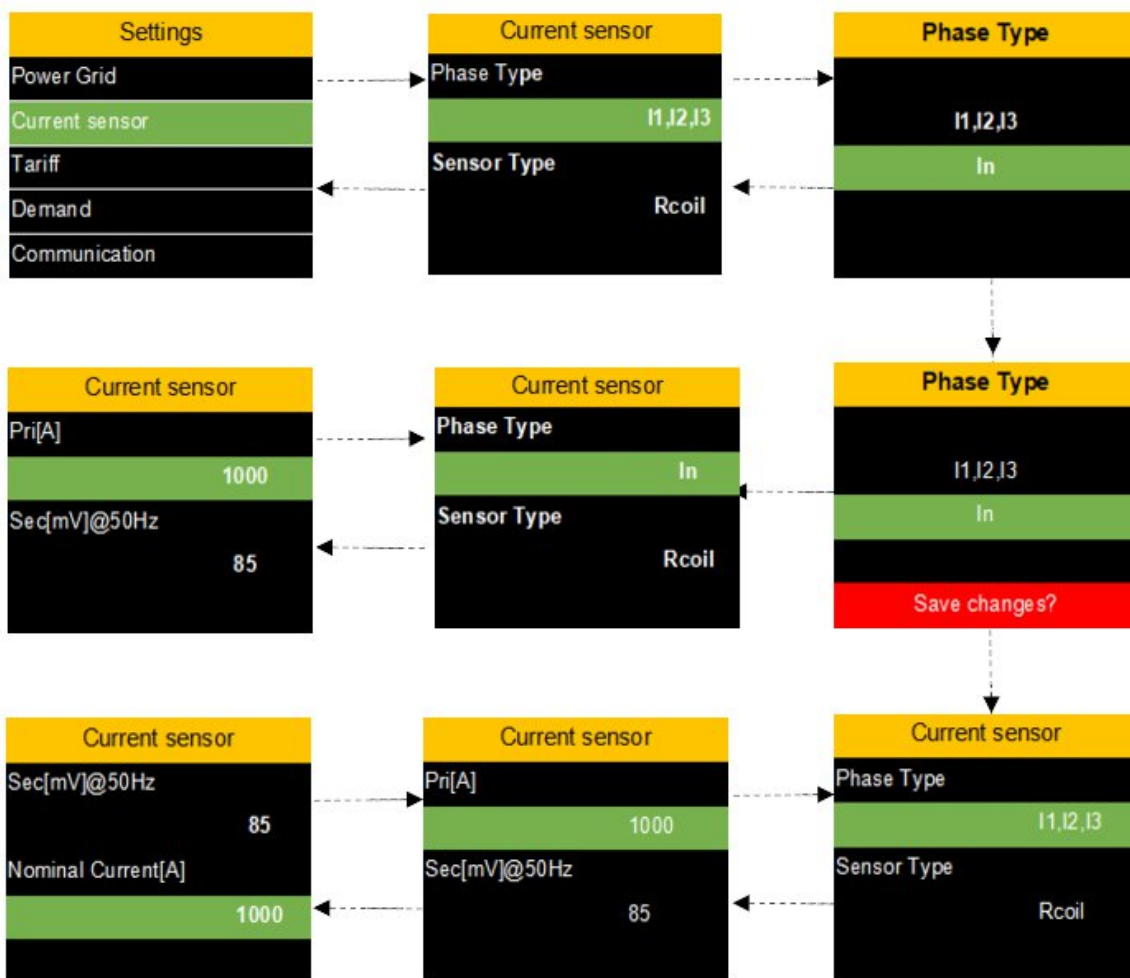
Parameter	Explanation
Sensor type	Rcoil: Rogowski coil VCT: Voltage output type CT
Rcoil Pri	Rated primary current of Rogowski coil
Rcoil Sec	The secondary output value corresponding to the rated primary current
Nominal Current	The actual measured rated current value
For example, Coil Ratio: 85 mV/kA@50Hz, Rcoil Pri =1000 A, Rcoil Sec = 85 mV, If measure 2000 A, then Nominal Current = 2000A. If you want to measure 100A, change to keep 100 A nominal current.	
To replace the coil with different ratios, the Pri/Sec must be reset.	



### 6.5.3 Settings Menu - Tariff Interface

Press **OK** to enter the Tariff setting page. Press  or  to modify the value. After the data modification is completed, a prompt appears asking whether you wish to save the changes. Press **OK** or **ESC** key to save or not save the changes.

The Tariff sub-menu can set Switch Mode, Start time, Tariff select.



Switch Mode: Manual\RTC

RTC Mode: Can set Ta, Tb, Tc, Td, Te, Tf, 6 Start time and 6 Tariff select.

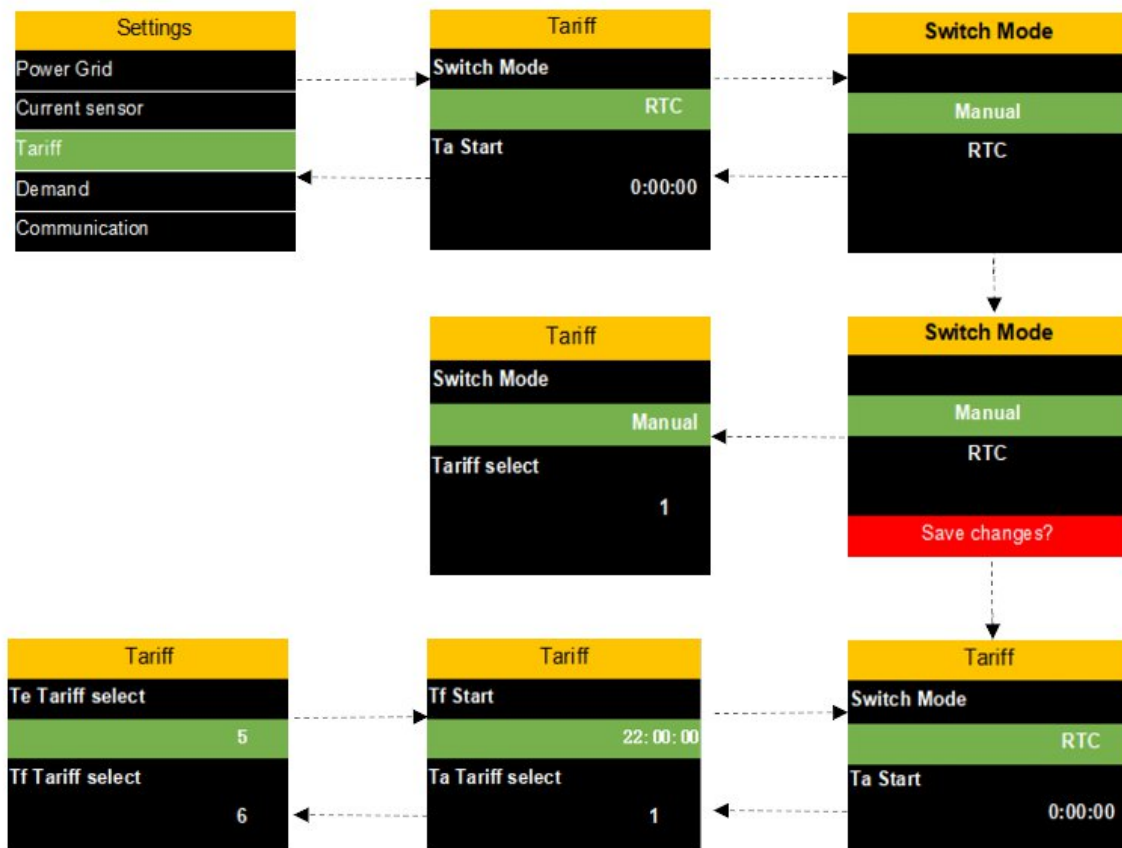
Manual Mode: Can set Ta, Tb, Tc, Td, Te, Tf, 6 Tariff select.



### 6.5.4 Settings Menu - Demand Interface



Press **OK** key to enter the Demand setting page. Press  or  to modify the value. After the data modification is completed, a prompt appears asking whether you wish to save the changes. Press **OK** or **ESC** key to save or not save the changes.

The Demand sub-menu can set Method, Block[minute].

Parameter	Explanation
Calculation method	Fixed: update the demand according to the calculation interval Sliding type: update the demand once a minute
Calculation interval	Unit: minutes Range: 1-60, Default: 15 minutes



### 6.5.5 Settings Menu - Communication Interface

Press **OK** key to enter the Communication setting. Press  or  to modify the value. After the data modification is completed, a prompt appears asking whether you wish to save the changes. Press **OK** or **ESC** key to save or not save the changes.

The Communication sub-menu can set Status, Device ID, Baud rate[bps], Parity, Stop bits.

Status: Enable \ Disable

Device ID: 000-247

Baud rate[bps]: 2400, 4800, 9600, 19200, 38400

Parity: None, Odd, Even

Stop bits: 1 \ 2

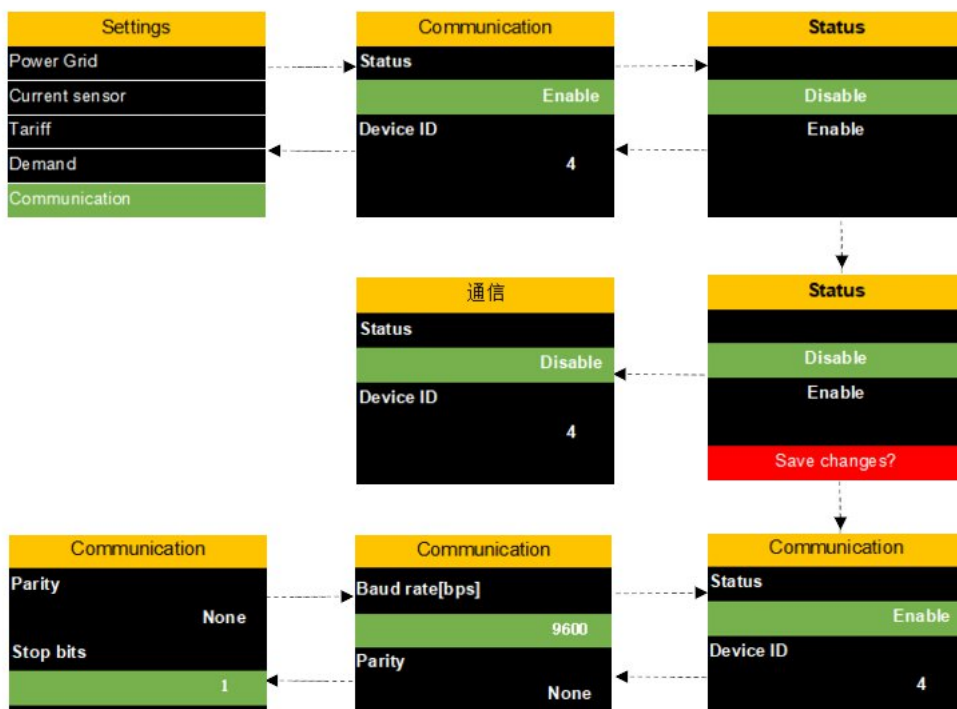

### 6.5.6 Settings Menu - HMI Interface

Press the OK key to enter the HMI setting. Press or to modify the value. After the data modification is completed, a prompt appears asking whether you wish to save the changes. Press **OK** or **ESC** key to save or not save the changes.

The HMI sub-menu can set Language, Clock, Key Tone, Backlight OFF, Backlight Brightness.

Language: 中文 \ English

Clock: Year / month / day time: minutes: seconds





Key Tone: Enable \ Disable

Backlight OFF: Never \ 1 minute \ 2 minutes \ 3 minutes \ 4 minutes \ 5 minutes

Backlight Brightness: 1-5



### 6.5.7 Settings Menu - Password Interface

Press OK key to enter the Password setting page. Press  or  to modify value size. Press and hold  or  to switch displacement (the corresponding value will flash).

Press **OK** or **ESC** key to save or not save the changes.

The **Password** sub-menu can set settings password, reset password.

Settings password: 0001-9999

Reset password: 0001-9999





### 6.6 Reset Menu Interface

The reset menu is used for resetting Max.Min., Demand Max., Tariff Energy, Energy, and Factory Set.

Before entering the configuration page, you need to enter the configuration password (default 2000). Press **OK** to confirm the

password, and press or to modify the value size; press and

hold or to switch displacement (the corresponding value will flash). Input the password correctly, and press **OK** Key to enter the configuration interface. If entering the wrong password, you will stay in the password input interface.

If you forget the configuration password, you can enter the last four digits of the device serial number to enter the configuration interface.



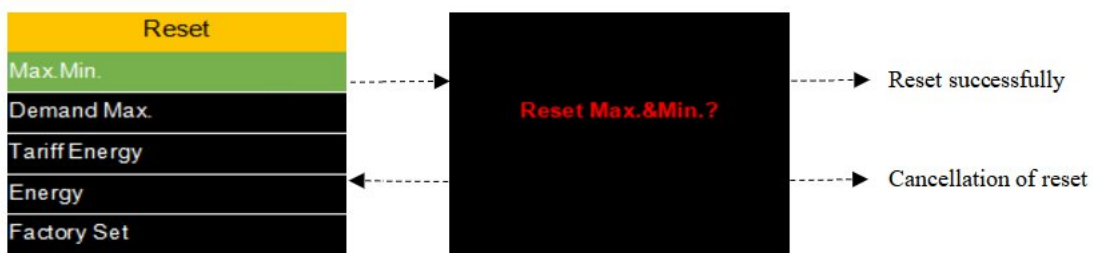

Press or to switch the display of the interface. Press **OK** Key to enter parameter configuration.



### 6.7 Device Information Menu Interface

The device information menu is used to display: Device model, S/N, Firmware, Communication, Power grid parameters, and other data.

Press  or  to switch the display of the interface.

The **Device information** menu is shown in the figure below:

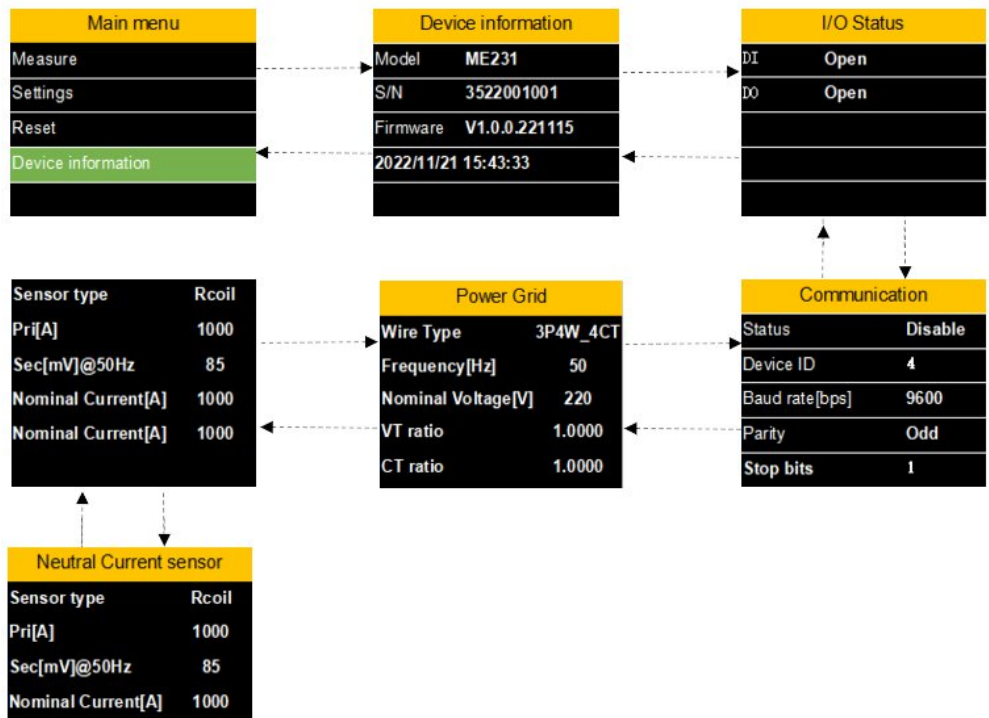

## 7 Modbus Communication

For Modbus registers, scan the QR code to see the S111 Modbus register table manual.



## 8 Maintenance



### **ATTENTION!**

**Do not use isopropyl alcohol to clean the power meter!**

## 9 Disposal or Waste



Electronic devices are recyclable material and do not belong in the household waste.

The sensor, the accessories and its packings must be disposed according to your local statutory requirements.

The dispose can also be carried by the manufacturer of the product, for this please contact the manufacturer.

---

**SUTO iTEC GmbH**

Grißheimer Weg 21  
D-79423 Heitersheim  
Germany

Tel: +49 (0) 7634 50488 00  
Email: [sales@suto-itec.com](mailto:sales@suto-itec.com)  
Website: [www.suto-itec.com](http://www.suto-itec.com)

---

**SUTO iTEC (ASIA) Co., Ltd.**

Room 10, 6/F, Block B, Cambridge Plaza  
188 San Wan Road, Sheung Shui, N.T.  
Hong Kong

Tel: +852 2328 9782  
Email: [sales.asia@suto-itec.com](mailto:sales.asia@suto-itec.com)  
Website: [www.suto-itec.com](http://www.suto-itec.com)

---

**SUTO iTEC Inc.**

5460 33rd St SE  
Grand Rapids, MI 49512  
USA

Tel: +1 (616) 800-7886  
Email: [sales.us@suto-itec.com](mailto:sales.us@suto-itec.com)  
Website: [www.suto-itec.com](http://www.suto-itec.com)

---

All rights reserved ©

Modifications and errors reserved

S111\_IM\_EN\_V2025-1-1

---