

Instruction and Operation Manual

S605

Portable Breathing Air Quality Analyzer



Dear Customer,

Thank you for choosing our product.

Before starting up the device, please read the manual in full and observe the operating instructions stated. The manufacturer cannot be held liable for any damage which occurs as a result of non-observance or non-compliance with this manual.

Should the device be tampered with in any manner other than a procedure which is described and specified in the manual, the warranty is void and the manufacturer is exempt from liability.

The device is designed exclusively for the described application.

We offer no guarantee for the suitability for any other purpose. We are also not liable for consequential damage resulting from the delivery, capability or use of this device.

Revision: 2025-3



Last modifications: March, 2025

Table of Contents

1	Safety Instructions.....	5
2	Registered Trademarks.....	8
3	Application.....	8
4	Features.....	8
5	Technical Data.....	9
5.1	General Data.....	9
5.2	Operating Conditions.....	9
5.3	Measurement Data.....	10
6	Dimensional Drawings.....	12
7	Installation on Site.....	13
7.1	Compressed Air Inlet.....	14
7.2	Compressed Air Connections.....	15
7.2.1	Installation Requirements.....	15
7.2.2	Installation.....	16
7.3	Electrical Connectors.....	17
7.4	Electrical Connections.....	17
7.4.1	RS-485 Networking (Modbus/RTU).....	17
7.4.2	TCP/IP Networking (Modbus/TCP).....	18
7.4.3	Connect with a PC or an OTG USB Stick.....	18
7.5	Water Filling Connector.....	18
7.5.1	Fill Water to the Humidifier.....	19
7.6	Calibration Connector	20
8	Setup and Configuration.....	20
9	Operation.....	21
9.1	Main Screen.....	23
9.1.1	Quick Buttons and Icons.....	23
9.1.2	Icons in the Status Bar.....	23
9.2	Value View.....	24
9.3	Graphic View.....	24
9.4	Menu.....	25
9.5	Configure S4A Remote Connection.....	26
9.6	SIM Card Requirement for 4G/LTE Option.....	27
9.6.1	Data Traffic.....	27
9.6.2	PIN Code Protection.....	27
10	Guided Measurement.....	28
10.1	Steps for Guided Measurement.....	30
10.2	Reports for Guided Measurements.....	32
11	Firmware Updates.....	33
12	Calibration.....	35

12.1 Calibration for DP Sensor and Oil Sensor.....	35
12.2 Calibration for O2, CO, CO2 Sensor.....	35
12.2.1 Calibration Gases.....	36
12.2.2 Calibration Procedure.....	36
13 Optional Accessories.....	42
14 Maintenance.....	42
15 Disposal or Waste.....	42
16 Warranty.....	42
17 Appendix - Modbus Holding Register Table.....	43
17.1 Modbus Interface.....	43
17.2 Modbus Register Table.....	44
17.3 Unit and Resolution	47

1 Safety Instructions

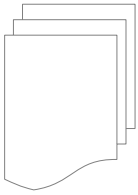

Please check if this instruction manual matches the product type.

Please observe all notes and instructions indicated in this manual. It contains essential information which must be observed before and during installation, operation and maintenance. Therefore this instruction manual must be read carefully by the technician as well as by the responsible user / qualified personnel.

This instruction manual must be available at the operation site of the flow sensor at any time. In case of any obscurities or questions, regarding this manual or the product, please contact the manufacturer.

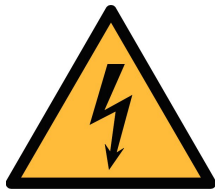

WARNING!

Compressed air!

Any contact with quickly escaping air or bursting parts of the compressed air system can lead to serious injuries or even death!

- Do not exceed the maximum permitted pressure range (see sensors label and/or the specifications written in this manual).
- Only use pressure tight installation material.
- Avoid that persons get hit by escaping air or bursting parts of the instrument.
- The system must be pressure less during maintenance work.

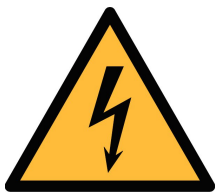

WARNING!

Voltage used for supply!

Any contact with energized parts of the product may lead to an electrical shock which can lead to serious injuries or even death!

- Consider all regulations for electrical installations.
- The system must be disconnected from any power supply during maintenance work.
- Do not exceed the permitted operating parameters as specified in the data sheet, this manual or written on the instrument.
- Make sure the product is operated in its permitted limitations.

- Do not exceed or undercut the permitted storage and operation temperature, pressure and humidity.
- The product should be maintained and calibrated frequently, at least annually. For more information, please contact the customer support.

General safety instructions

- It is not allowed to use the product in explosive areas.
- Please observe the national regulations before/during installation and operation.

Remarks

- It is not allowed to disassemble the product.
- Always check the compressed air connectors in terms of stability and tightness before any operation.



ATTENTION!

Measurement values can be affected by malfunction!

The product must be installed properly and frequently maintained, otherwise it may lead to wrong measurements, which can lead to wrong results.

- The instrument must be operated within or better than compressed air quality Class 4.5.4 according to the ISO8573-1. If the air quality cannot reach the specified class, the device may show wrong measurement values or even may get damaged.
- Do not exceed the maximum operation temperature or pressure.
- Avoid condensation inside the instrument caused by the supplied air or gas because it harms the instrument and affects the accuracy.
- It is recommended that before any operation you examine the instrument in terms of the measurement accuracy and deviations. To do this, you may use high efficiency filters for oil vapor and particle, and the instrument should show low values close to zero. Additionally, it is recommended you examine the dew point measurement to ensure it is working correctly. To do this, you may use a dry gas with a defined dew point value which should be reached within several minutes. Or you may use any reference meter. Only after doing these examinations, you can rely on the measurement results after the instrument have been used for other measurement cycles.

- Always perform a visual inspection in prior to every measurement before connecting compressed air. If any loose objects are found, do not connect the compressed air because it may lead to a damage or injuries.

Storage and transportation

- Make sure that the transportation temperature is between -10... 50°C.
- For transportation it is recommended to use the packaging which comes with the sensor.
- Please make sure that the storage temperature of the sensor is between -10... 50°C.
- Avoid direct UV and solar radiation during storage.
- For the storage the humidity must be < 90%, no condensation.



ATTENTION!

Equipment may get damaged!

Please make sure, that your measuring point is free of excessive contamination/dirt. This should be maintained before every measurement.

- Observe the measuring point always before measurement if it is free of contamination like water drops, oil drops or other rough contaminants.
- Should water hit the inner electronics, the sensors could be seriously damaged.
- Any rough contamination of particles, water, oil or other impurities may damage the instrument or affect the accuracy.
- Check your measurement point with the enclosed test kit, by purging air in prior to the use of the instrument through the test kit. A clean tissue may help to identify oil, water or any other lubricants in the air.

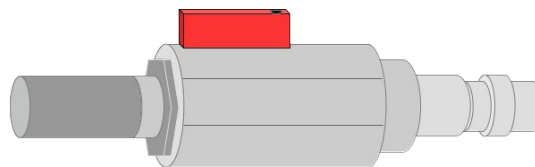

2 Registered Trademarks

SUTO®	Registered trademark of SUTO iTEC
MODBUS®	Registered trademark of the Modbus Organization, Hopkinton, USA

3 Application

The S605 Portable Breathing Air Quality Analyzer measures the content of O₂, CO, CO₂, H₂O and Oil vapor according to the breathing air purity standards. It monitors the contaminant concentration to ensure that the breathing air quality complies with international standards such as EN 12021 or CFSR 1910.134(d).

The S605 is mainly used in an industrial environment. It can not be used in hazardous or explosive environment and it not suited for permanent outside applications.

4 Features

- All-in-one device measures O₂, CO, CO₂, H₂O, Oil, and pressure.
- Portable design makes it to be carried with one hand.
- The device has a DC power supply and additionally a battery which can bridge power failures.
- High resolution 5" color touchscreen display.
- Software guided measurement.
- USB port for transferring data to a USB-OTG memory.
- Modbus/TCP and Modbus/RTU interfaces for communication.
- Data logger with the capacity of 30-million values.
- Only one gas inlet for all parameters.
- 0.4...1.5 MPa(g) pressure at inlet; higher pressure is available with external pressure reducer.
- With optional 4G modem feature (P/N: A1670) and dedicated S4A software, you can check the online measurement values, read out the logging files remotely.

5 Technical Data

5.1 General Data

	
Display	Touchscreen, Size: 5", Resolution: 800 x 480 pix
Power supply	Mains supply adapter (AC/DC) Input: 100 ... 240 VAC, 50/60 Hz, 1.8 A Output: 20 VDC, 3.25 A, 65 W max
Internal battery	7500 mAh Rechargeable for nearly 3.5 hours operation Charging time about 1.5 hours
Process connection	Micro quick connector, full pass through, male (1.5 m hose with coupling included)
Interface	USB M12 (Modbus/RTU) Ethernet (Modbus/TCP) USB-A for 4G/LTE modem (optional)
Data logger	Internal, 30-million values
Housing material	PC + ABS, Aluminum
Protection class	IP54 (cover closed)
Dimension	470 x 365 x 181 mm
Approvals	FCC, EC
Weight	11 kg

5.2 Operating Conditions

Measuring medium	Compressed breathing air
Humidity of the medium	< 40%, non condensation
Temperature of the medium	0°C ... +50°C
Operation pressure	0.4 ... 1.5 MPa(g) Higher pressure needs an external pressure reducer.
Storage & Transport temperature	-10°C ... + 50°C
Ambient temperature	0°C ... +50°C

Ambient humidity	0 ... 90% rH
Sampling flow rate	6 LPM@4 MPa(g), depends on input pressure
Sampling rate	1 sample/sec

5.3 Measurement Data

Oil Vapor Sensor (only for S605-I version)

Measuring range	0.001... 5.000 mg/m ³ (Based on 1000 hPa(a), 20°C, 0% relative humidity)
Accuracy	5% of reading ± 0.003 mg/m ³
Resolution	0.001 mg/m ³
Sensor principle	Photo ionization detector
UV lamp lifetime	6,000 working hours or 1 year, whichever comes first

Oil Mist and Particle Sensor (only for S605-C version)

Measuring range	0.0 ... 10.0 mg/m ³ (Based on 1000 hPa(a), 20°C, 0% relative humidity)
Accuracy	15% of reading ± 0.1 mg/m ³
Resolution	0.1 mg/m ³
Sensor principle	Oil mist and particle sensor
Sensor lifetime	> 5 years

O₂ Sensor

Measuring range	0 ... 25%
Accuracy	±(1% of reading +0.05%)
Resolution	0.1%
Sensor principle	Optical oxygen sensor
Sensor lifetime	> 5 years

CO Sensor

Measuring range	0 ... 20 ppm
Accuracy	±(5% of reading +1 ppm)
Resolution	0.1 ppm
Sensor principle	Electrochemical sensor

Sensor lifetime	2 years
CO₂ Sensor	
Measuring range	0 ... 1000 ppm
Accuracy	±(1% of reading +25 ppm)
Resolution	1 ppm
Sensor principle	NDIR sensor
Sensor lifetime	> 5 years
H₂O (dew point)	
Measuring range	-100 ... +20 °C Td / 0 ... 17458.6 mg/m ³
Accuracy	±1 °C Td (0... 20 °C Td) ±2 °C Td (-70...0 °C Td) ±3 °C Td (-100... -70 °C Td)
Resolution	0.1 °C Td
Sensor principle	QCM + Polymer
Sensor lifetime	> 10 years
Pressure Sensor	
Measuring range	0... 16 bar(g)
Accuracy	0.5% FS
Resolution	0.01 bar
Sensor principle	Piezzo resistive pressure sensor

6 Dimensional Drawings

Dimension of S605 in mm (cover closed):



7 Installation on Site

Please make sure that all components listed below are included in your package.

Qty.	Description	Item No.
1	S605 Portable Breathing Air Quality Analyzer, in a hand carrying case with handle and shoulder belt	
1	USB OTG memory stick	S605-I version:
1	Purge filter for pre-measurement (test kit)	P560 0605 (with oil vapor sensor)
1	Power adapter Input: 100 ... 240 VAC, 50/60 Hz, 1.8A Output: 20 VDC, 3.25 A, 65 W max	S605-C version:
1	1.5 m Teflon hose with a quick connector and a compressed air coupling at each end	P560 1605 (with oil mist and particle sensor)
1	Water filling bottle	
1	Operation and instruction manual	
1	Certificate of calibration	
1	M12 connector	
1	USB 4G/LTE modem, including S4A software (option)	A1670

To replace the items in the preceding list or buy accessories, contact the manufacturer or your local distributor.

7.1 Compressed Air Inlet

The compressed air inlet is located on the right side of the S605 housing.

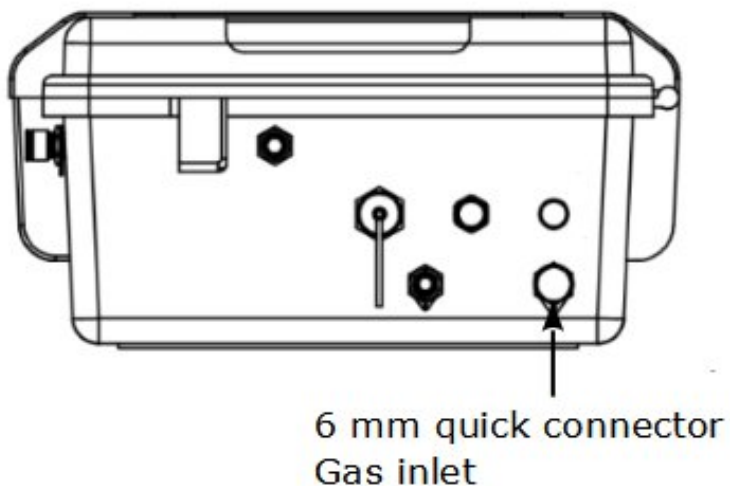

S605-I right view



ATTENTION!

Permissible pressure!

Please observe the maximum permissible inlet pressure. If the pressure exceeds the range, the device will be damaged. If the pressure is too low, the volumetric flow will not be high enough, which leads to wrong results.

7.2 Compressed Air Connections

7.2.1 Installation Requirements

Make sure that the installation meets the following requirements:

- The device must be set up next to the measuring point. Make sure that the device is put on a flat place.
- The tubes should be not bended heavily and should be installed with a big curve radius to avoid turbulence in the air flow.
- Connect the S605 to the power during the measurement, and make sure that the device is not turned off or plugged off during the measurement because data will then be lost.



ATTENTION!

If the device is not installed properly it may lead to wrong measurement results.

- The device is designed to be operated indoors only. To use the device outdoors, protect the device from direct sunlight and rain.
- Before you start the measurement, check your point of measurement for contaminants.



ATTENTION!

Before you connect the device to your point of measurement, make sure that there is no rough contamination like water/oil drops or heavy dust. This may damage the sensor units. For this please use the purge filter test kit.

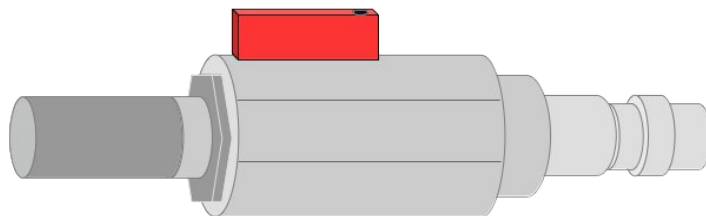

Before each measurement, the measuring point should be checked for coarse contamination. Follow the steps below:

1. Connect the purge filter test kit onto your measuring point first. Turn on the purge valve on the test kit and purge air for a short period.
2. Check the filter in the test kit to identify whether it shows high contamination of water, oil or dust.
3. If the filter is contaminated severely, stop using the S605 for measurement because this may lead to serious damage to the device. In case you are not sure, please contact the manufacturer.

7.2.2 Installation

1. Remove the protection cap from the air inlet of the S605.
2. Connect your compressed air system to the air inlet of the S605 by using the supplied Teflon hose.

Notes:

- Make sure you are using clean and oil-free components when connecting the instrument.
- The compressed air supply must always be applied carefully. If you are using ball valves, turn on them carefully and slowly. If you observe any unexpected noise or air leakage, shut down the compressed air supply immediately and disconnect the instrument.

7.3 Electrical Connectors

Three connectors are available on the right side of the S605.

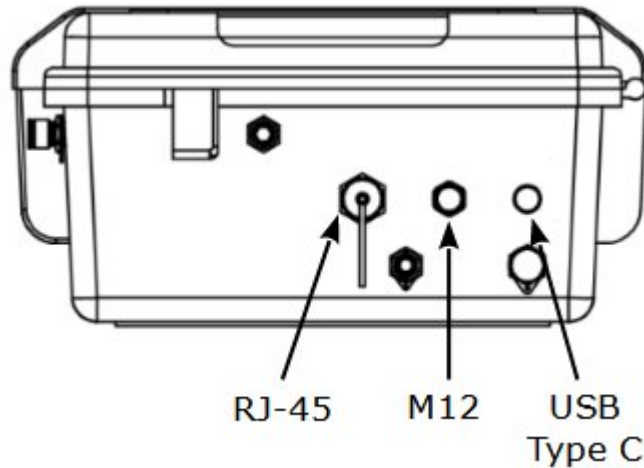

S605-I right view

Type	Description
RJ-45	Modbus/TCP
M12	Modbus/RTU
Type-C USB	Power supply connector /Battery charger interface



ATTENTION!

Please connect the power correctly! If wrong supply is used such as AC power, the instrument may get damaged.

7.4 Electrical Connections

7.4.1 RS-485 Networking (Modbus/RTU)

Through the M12 connector, the S605 can be connected to the RS-485 network over the Modbus/RTU protocol.

The RS-485 networking uses the following 3 pins in the M12 connector. The pin functions are described below.

Pin No.	Assignment	Function
4	Data +	Data + signal
5	Data -	Data - signal
1	GND RS-485	Ground of RS-485

7.4.2 TCP/IP Networking (Modbus/TCP)

Through the RJ-45 connector, the S605 can be connected to the TCP/IP network over the Modbus/TCP protocol.

Remove the protection cap and plug in the network cable (RJ-45).

For more information about the data attributes of measurement channels, see Error: Reference source not found.

7.4.3 Connect with a PC or an OTG USB Stick

Through the USB port on the front panel, the S605 can be connected with:

- An OTG memory stick: To import firmware for upgrade and to export data.
- A PC where data analysis software such as S4A or S4M is installed: To export data to the PC for analysis.

7.5 Water Filling Connector

To ensure that the measured gas is in a reasonable humidity, a humidifier is integrated in the S605, thus the CO sensor will not be damaged because the measured gas is too dry.

The water filling connector of the humidifier is on the front side of the S605. The water draining connector (i.e., air outlet) is on the right of the S605.

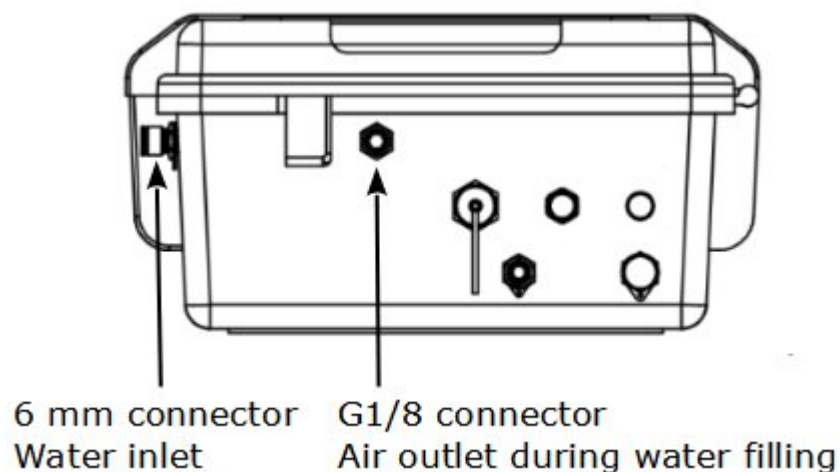

S605-I right view

7.5.1 Fill Water to the Humidifier

When the water level is too low, the low water level indicator  in the status bar will blink, signaling the need to replenish water for the humidifier. The humidifier has a capacity of approximate 200 ml.

Preparation:

- Use pure or demineralized water for the humidifier.
- A water filling bottle is included in the package.

Filling Process:

1. Fill the supplied bottle with a sufficient amount of pure or demineralized water.
2. Remove the protection caps from both the water inlet and air outlet.
3. Insert the bottle nozzle into the water inlet connector, then squeeze the bottle to dispense water into the humidifier.
4. Monitor the water level indicator on the status bar during filling.

Stop when the high water level indicator  appears.

5. Disconnect the water filling bottle from the connector, and secure the protective caps onto both the water inlet and air outlet.



ATTENTION!

Before using the product for the first time, ensure it is filled with pure or demineralized water. Use of unclean water may lead to scaling and contamination of sensors.

If the product remains unused for an extended period, drain the water.

Once the S605 is operational, promptly replenish the water to maintain functionality.

Under typical conditions, the humidifier's lifespan is approximately 18 days. Inadequate water levels can significantly reduce the lifespan of the CO sensor or potentially damage it.

7.6 Calibration Connector

The calibration connector is located on the right side of the S605. When the sensors need to be calibrated, remove the connector cap, then connect the calibration hose. When the calibration is finished, put on the cap to avoid the dust or other substance entering. For more information on calibration procedure, see section 12 Calibration.

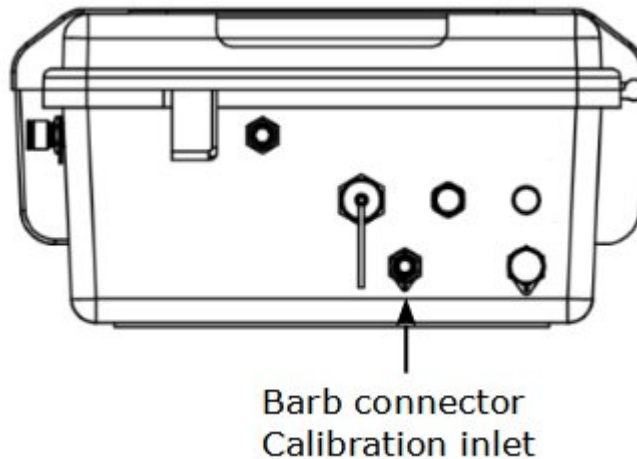

S605-I right view

8 Setup and Configuration

The S605 is configured ex-works and ready to work when you get it. The S605 provides a guided measurement procedure to take you through device setup for each measurement parameter. All these setup settings are automatically saved into the device even on a power failure.

For more information about the guided measurement procedure, see section 10 Guided Measurement.



ATTENTION

If you are facing problems setting up your device, contact the manufacturer or your local dealer for assistance.

If power outage occurs during the measurement, the measurement data will not be saved!

9 Operation



After the S605 is powered on, the initialization screen is displayed with an active progress bar.

During the initialization, the device configures the sensors and runs initialization routines.

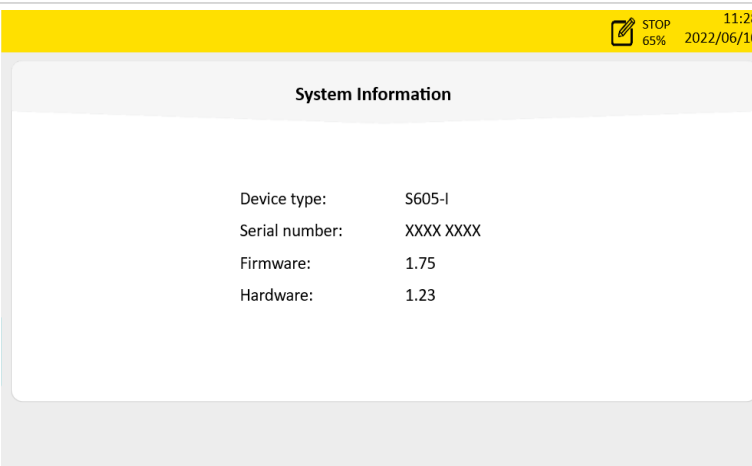

After the initialization is completed, the system information is shown including device type, serial number, and more. This information displays for 3 seconds then moves to the next page.

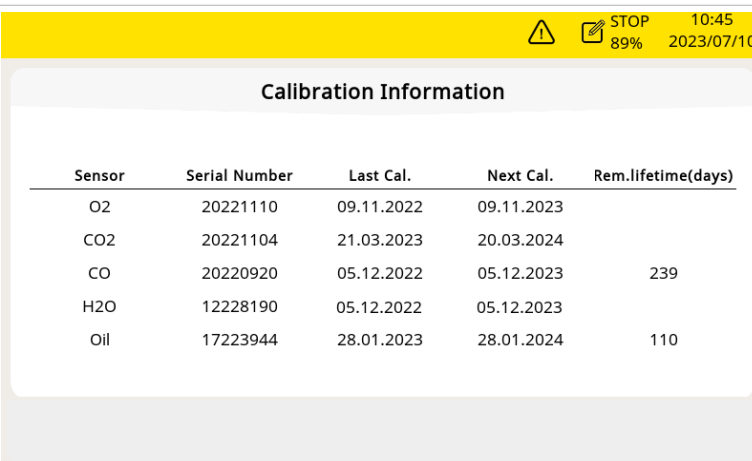

The sensor information screen shows the important maintenance information of the sensor. This screen displays for 3 seconds then moves to the next page.

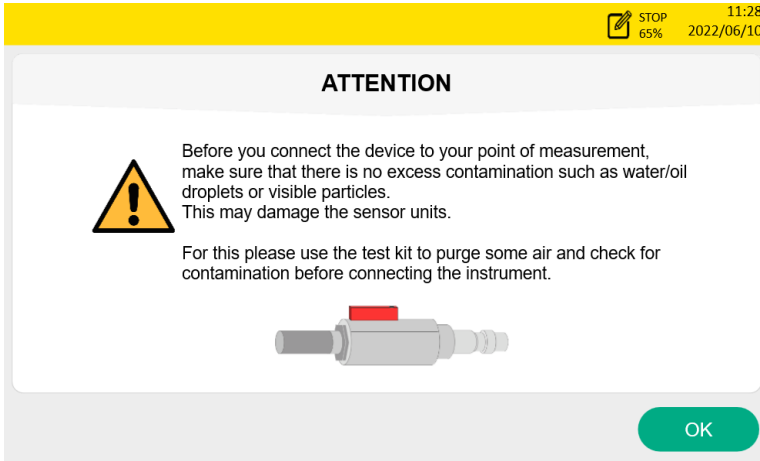

The attention screen reminds to use the test kit to avoid the sensor damage. Click **OK** to move to the next screen.

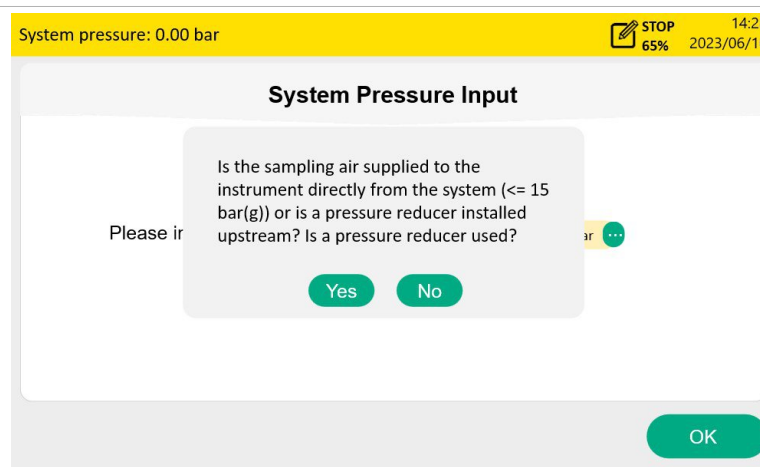

This screen asks if the system pressure needs to be entered. If you perform a high pressure measurement (>15 barg) through a pressure reducer, enter the system pressure before the pressure reducer. Click **Yes** to input the system pressure. Clicking **No** goes to the Value screen.

Note: If your system pressure is greater than 15 bar, make sure to enter your system pressure correctly, otherwise it may affect the measurement!

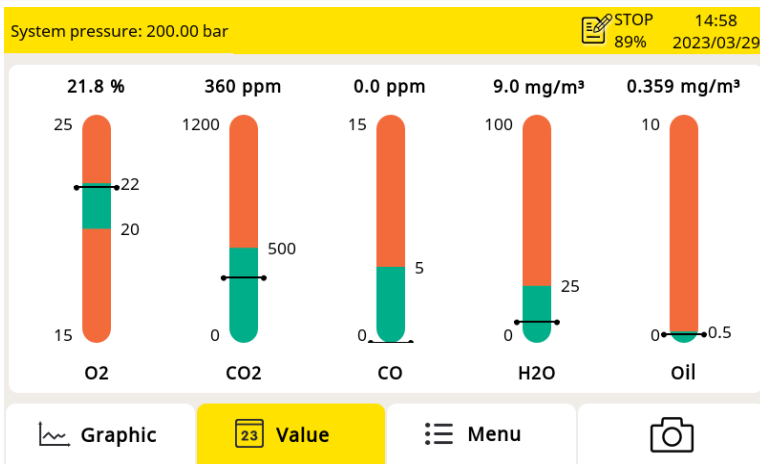

The value screen appears, as shown on the left.

9.1 Main Screen

The following figure shows the main screen in the value view.

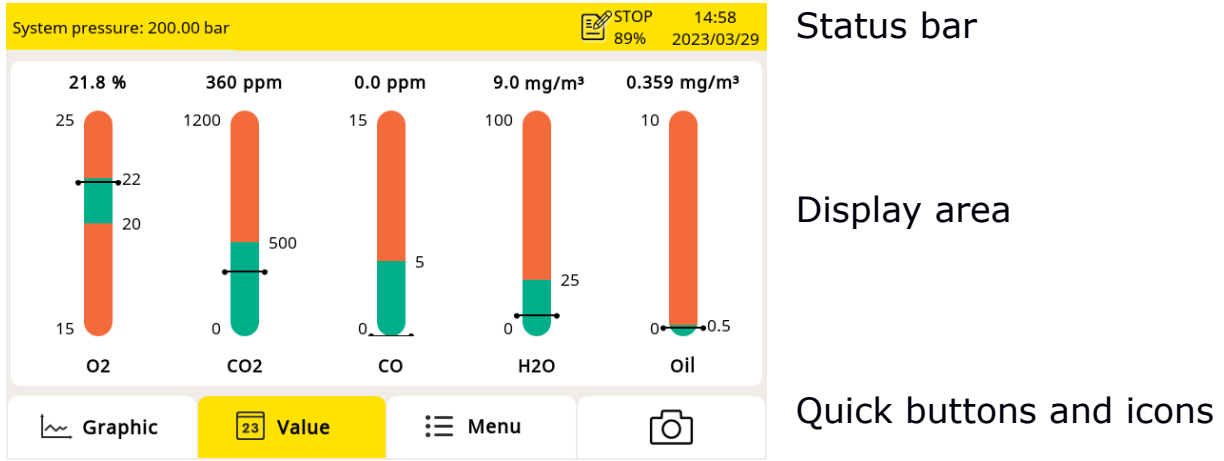

9.1.1 Quick Buttons and Icons

Buttons and icons	Description
	To switch to the graphic view of measurement data
	To switch to the value view of measurement data
	To access the operation menus
	To take a screenshot

9.1.2 Icons in the Status Bar

	System errors occur. Press this icon to get further information.		Calibration is expired. Contact the manufacturer or your local dealer.
	Low water level indicator		High water level indicator
	4G/LTE signal strength		S4A remote connected
	Data logger status: - STOP—Indicates that the data logger is not running. - LOG—Indicates that the data logger is running.		

9.2 Value View

All measured values, channel range, limit value, alarms can be viewed in realtime.

The green color bar area indicates the valid range; the red color bar area indicates the invalid range. When the measured value exceeds the alarm threshold, the data color will be red and keep blinking.

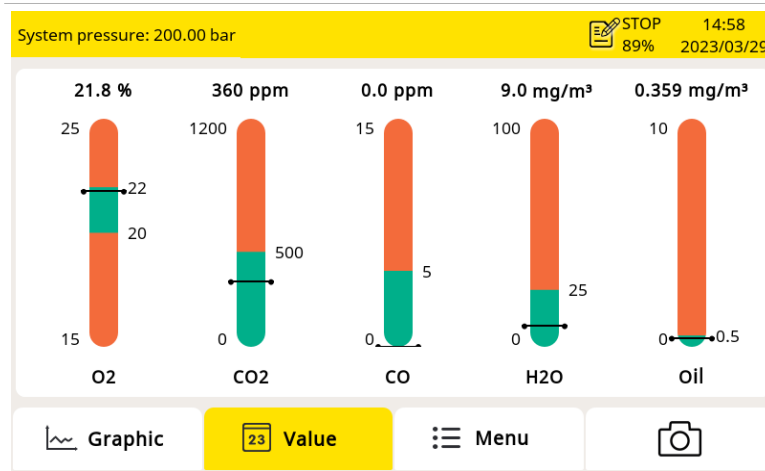

To switch to the value view, click **Value** in the bottom.

9.3 Graphic View

The measured result is shown in a curve when the recording is activated. It shows the last 30 minutes by default.

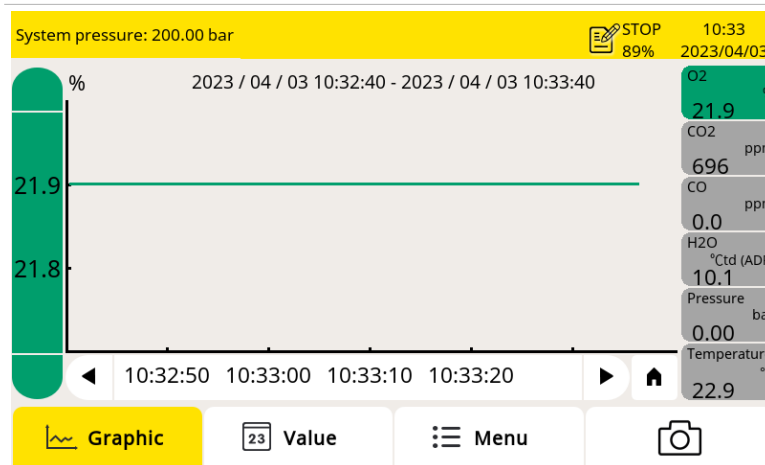

To switch to the Graphic view, click **Graphic** on the bottom.

The graphic view is pre-configured in the factory, and you do not need to change anything.

If you make changes, follow the description below.

Item	Description
Y-axes	Touch Y-axes to scale it.
X-axes	Touch X-axes to define viewing period.

Item	Description
	Scroll time.
	Click the icon to go back to the current time.
Channel data area	- Short touch can switch through single channel. - Long touch is for settings.

9.4 Menu

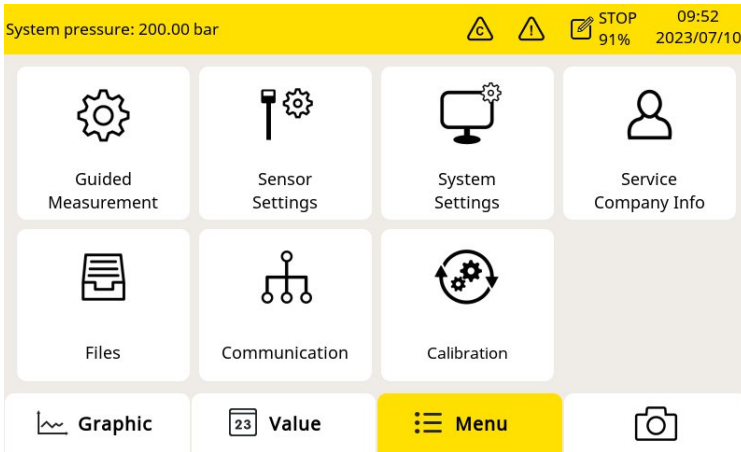

To access the main menu, click **Menu** in the bottom bar. All operation menus are displayed.

These operation menus are described below.

Guided Measurement

To start the guided measurements, which lead you through a complete measurement cycle.

For more information, see Chapter 10 Guided Measurement.

Sensor settings

To choose the different standards. When choosing the standard, the limit value is automatically set. The customer also can manually set the limit value according to requirements.

System settings

To configure system-level settings:

- To perform general settings on access code, date, time and language and so on.
- To view device information, such as the serial number, firmware and hardware versions.
- To calibrate the touch screen if it does not respond to user inputs correctly or precisely.
- To update the system firmware.

Service Company info

Show the service company contact information. You can import a logo file to the S605 through the USB port.

Files

To copy and delete the report files, recording files, calibration record files, captured screenshots and check the memory status.

Communication

To configure communication parameters. Only the following sub-menus are applicable to S605:

- **Modbus/TCP:** The S605 can be connected to the TCP/IP network over the Modbus/TCP protocol. In this sub-menu, select the communication protocol as required, and configure the IP address of the S605.
- **Modbus/RTU:** The S605 can be connected to the RS-485 network over the Modbus/RTU protocol. You can configure the communication parameters such as address, baud rate etc.
- **S4A Remote:** Used to configure the S605 to connect to the S4A remote server, viewing the measurement values, and reading out the logging files via the S4A software.

Calibration

This is used for the zero and span calibration for the O₂, CO, CO₂ sensors. You can check the calibration information for all the sensors include the exchange sensor unit.

9.5 Configure S4A Remote Connection

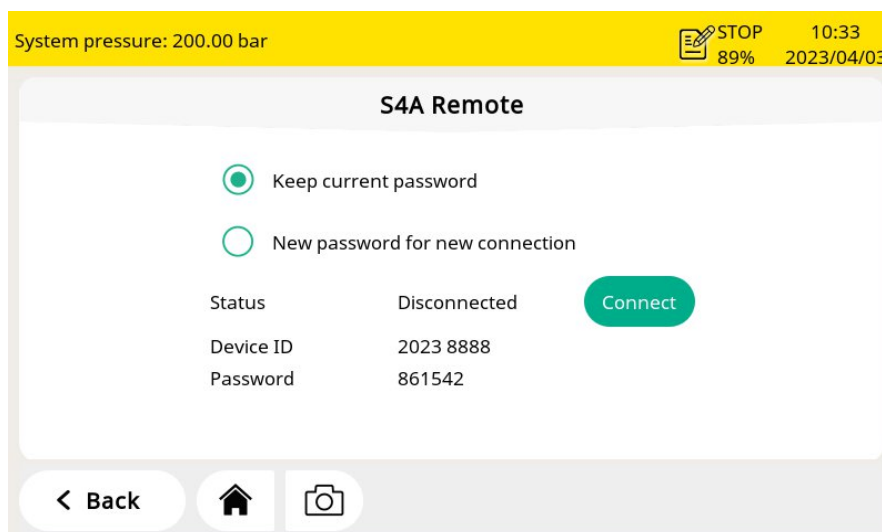

Follow steps below to connect S4A remote:

1. Install a SIM card into the provided 4G/LTE Modem and insert the 4G/LTE modem into the USB port.
Note: Turn off the S605 before inserting the 4G module, and turn on the S605 after the 4G module is inserted.
2. Click **Menu > Communication > S4A remote** to enter the S4A configuration page.
3. Input the device ID and password. Click **Connect** to connect the S605 to the S4A remote server.
4. Start the S4A software to establish the connection. Then you can view the online measurement values, and read out the logging files remotely with the S4A software.

For the detailed configuration steps, watch the instruction video which can be found on SUTO website.

9.6 SIM Card Requirement for 4G/LTE Option

To establish the 4G/LTE communication between S605 and S4A software with S4A remote function, customer needs to buy a SIM card locally.

9.6.1 Data Traffic

Data traffic required is 7 GB/month if the system is running 7×24 hours.

9.6.2 PIN Code Protection

The S605 does not support modifying PIN code on the screen. If your SIM card has PIN code protection, disable it by using other devices, for instance using your mobile phone.

10 Guided Measurement

The S605 provides a software-based guided measurement which takes you through the complete measurement. This leads to a simplified measurement process and prevents you from wrong measurements.

To start a guided measurement, do the following:

1. Click **Menu > Guided measurement**.

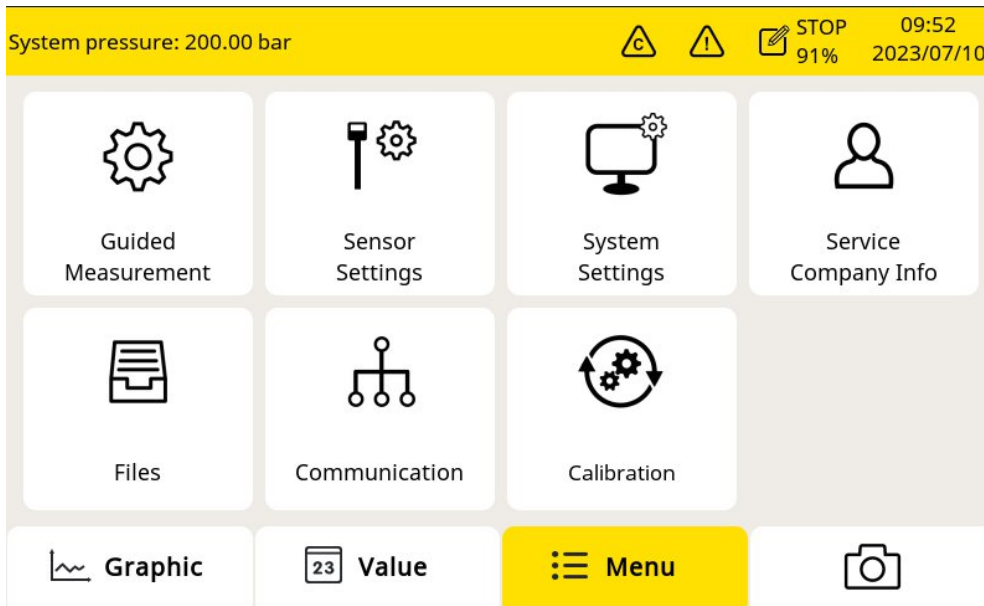

2. Select the type of measurement that you want to perform.

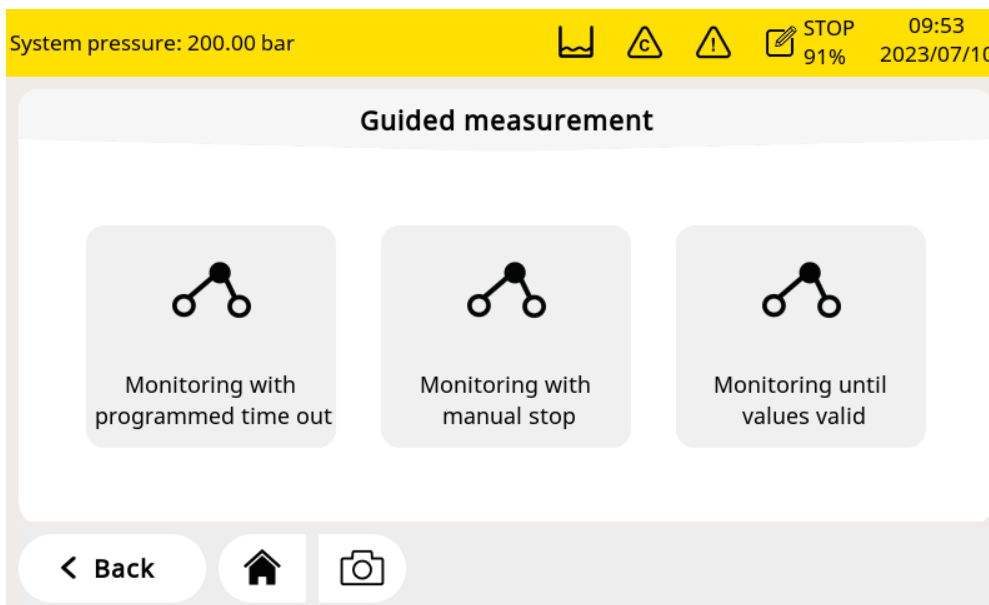

- **Monitoring with programmed time out:** It starts a measurement with a user-programmed period of measurement

time. You can set the measurement time during the process of measurement preparation. The system will then, after finishing the programmed measurement duration, stop the measurement automatically and save the data. This mode is ideally used for audits where you must measure at several points. You can program for each point a duration of e.g. 2 hours and then you can compare the measurements.

- **Monitoring with manual stop:** It starts the measurement without a programmed stop time. You can click it to start the measurement and stop it whenever you want. This mode can be used to monitor changes of values.
 - **Monitoring until values valid:** The measurement will stop when all values are within valid ranges for a certain time. This mode records the complete alarm information. The user can freely set the time out according to the requirement.
3. To perform the guided measurement, follow the onscreen instructions. For more information, see section 10.1 Steps for Guided Measurement.
 4. Before starting the measurement, it is recommended to select the standard to be followed first. The S605 will set the alarm threshold according to the selected standard, evaluate the air quality according to the standard, and show all the information in the report.
 5. To manage the measurement files generated, click **Menu > Files > Reports**.

10.1 Steps for Guided Measurement

After you start a guided measurement, follow steps below to go through the whole process.

1. Input the location information (that is, customer's data), which will be shown in the report.

2. Enter how long the measurement will last.
The longer it lasts, the more stabilized the values will be and the more closer it will approximate to the system reality.

Notes:

- In order to ensure the best measurement results, it is recommended to set the measurement time greater than 45 minutes.
- The step 2 comes up only when the **Monitoring with programmed time out** is selected.
- The **Monitoring with manual stop** indicates that no measurement duration needs to be entered.
- The **Monitoring until values valid** indicates the measurement duration and the valid time duration need to be entered.

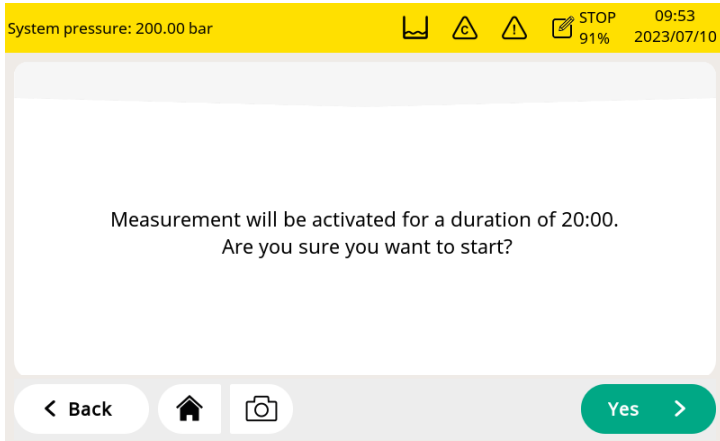

3. A confirmation displays before the measurement starts. Click **Yes** to start.

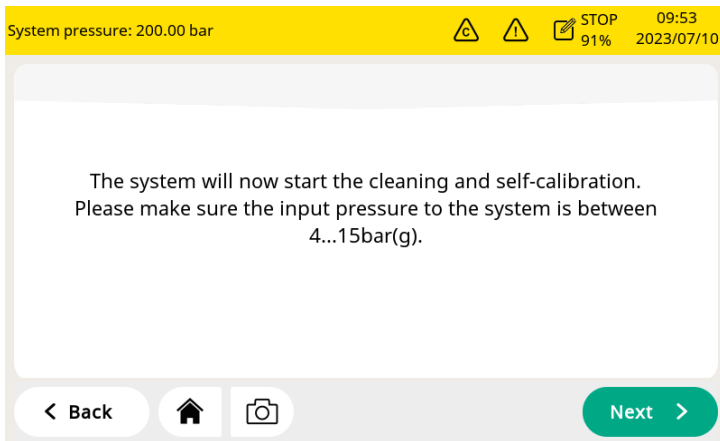

4. The system checks whether the pressure is in the valid range or not.

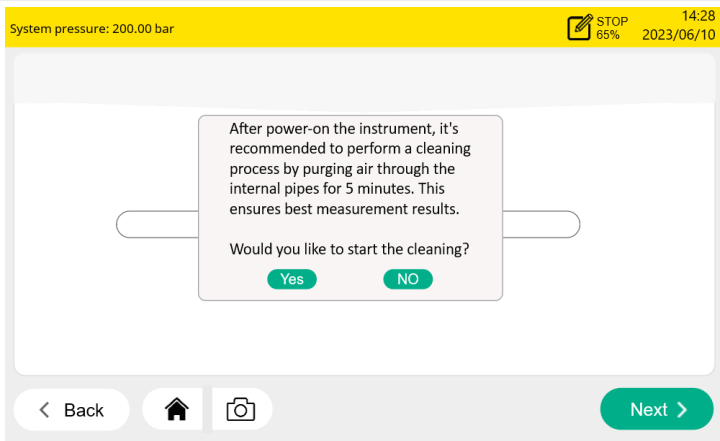

5. A pop-up appears and asks if the cleaning is needed. If you click **Yes**, the cleaning process starts. If you click **NO**, the measurement starts.

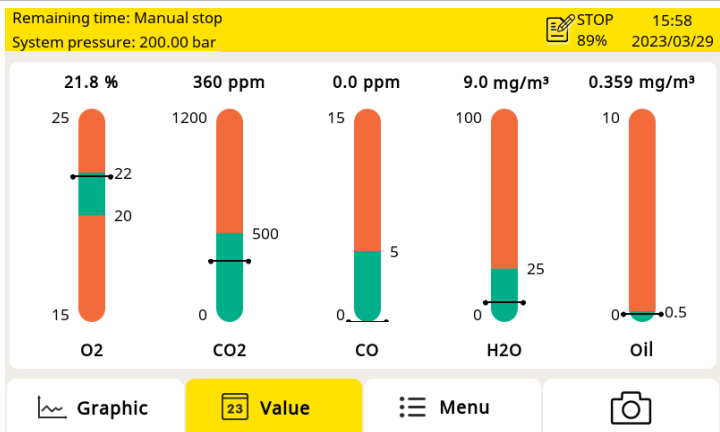

During the measurement, the data logger status icon on the status bar switches from **STOP** to **LOG**. The remaining time is displayed on the upper left corner. Please wait until the system completes the measurement.

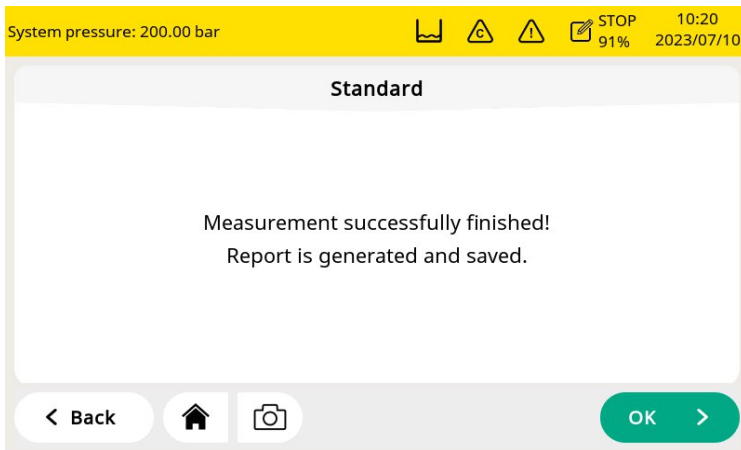

When the measurement is successfully completed, the screen on the left appears. Click **OK** to finish the measurement.

10.2 Reports for Guided Measurements

After performing guided measurements, you can view and manage measurement files through **Menu > Files > Reports**.

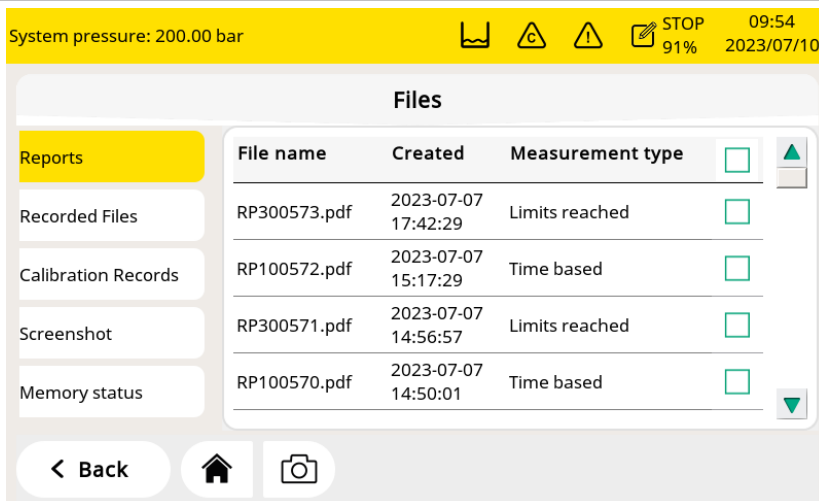

To copy or delete files, select the checkboxes, and click the corresponding button at the bottom.

Note: When the sensor data cannot be read out due to some abnormal conditions, the reading of the sensor will be shown ---- on the display and shown -9999 on the PDF report. In this case, the quality evaluation will be shown as N/A on the PDF report.

11 Firmware Updates

To update the firmware, just need a OTG-USB drive(supplied with the S605) and the firmware file (format like DIS605_1.82.tar)



1. Insert the USB drive to the connector on the front panel.
Make sure to do this after the S605 has fully booted.

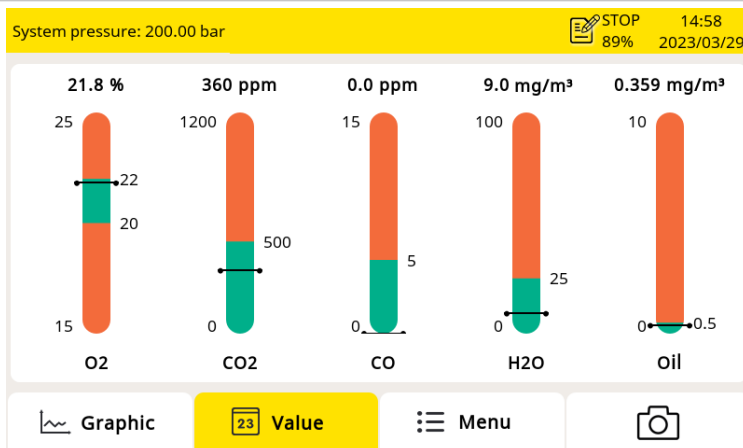

2. Click **Menu** to enter the Menu page.

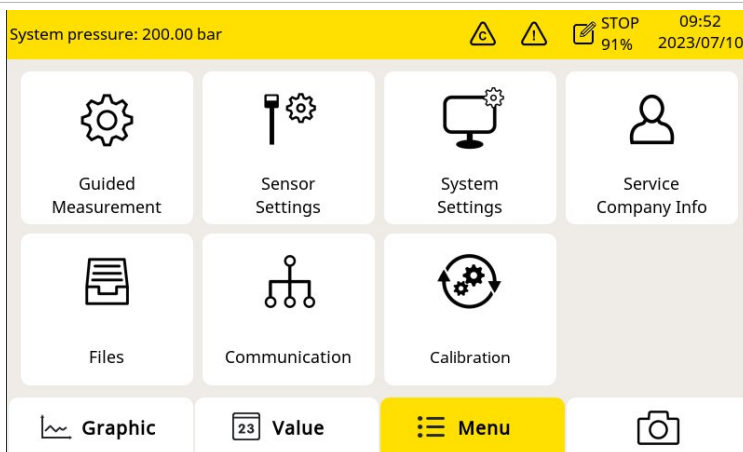

3. Click **System settings**.

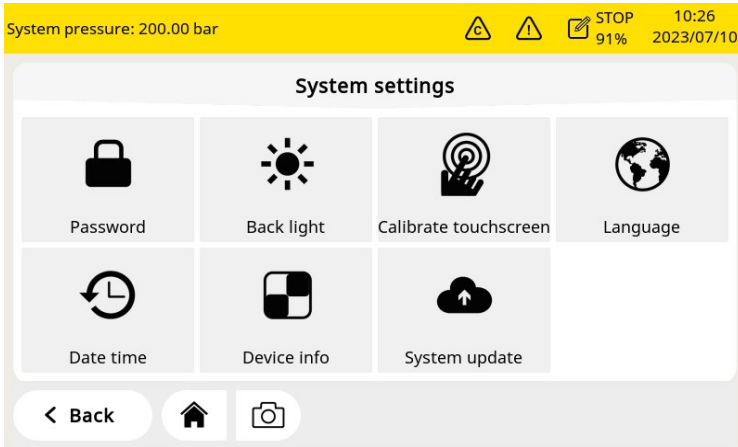

4. Click **System Update**.

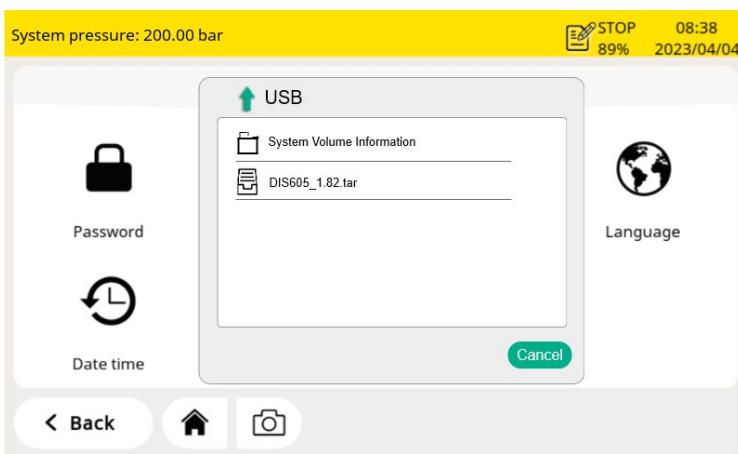

5. A pop up will be shown. Then click on the firmware file in this example DIS605_1.82.tar.

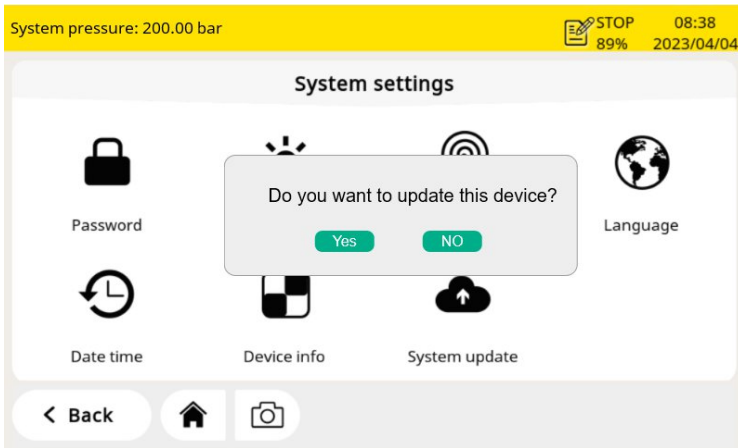

6. A new pop up will ask you to confirm the update. Click **Yes** to start the update. Click **NO** to abort the operation.

Notes:

Make sure you do not turn off the power.

Make sure you do not disconnect the USB drive.

Wait until the device is fully booted again before removing the USB drive.

After the update is done, you can select the new language or use new functions offered in the update.

12 Calibration

Because the sensor accuracy is affected by the environment conditions, it is recommend to calibrate the device at least once per year. It's also a good engineering practice to test the accuracy of the gas sensors from time to time before measurement and adjust the reading if required. The calibration should be done by trained personnel. You can check calibration information through **Menu > Calibration > Calibration Information**.

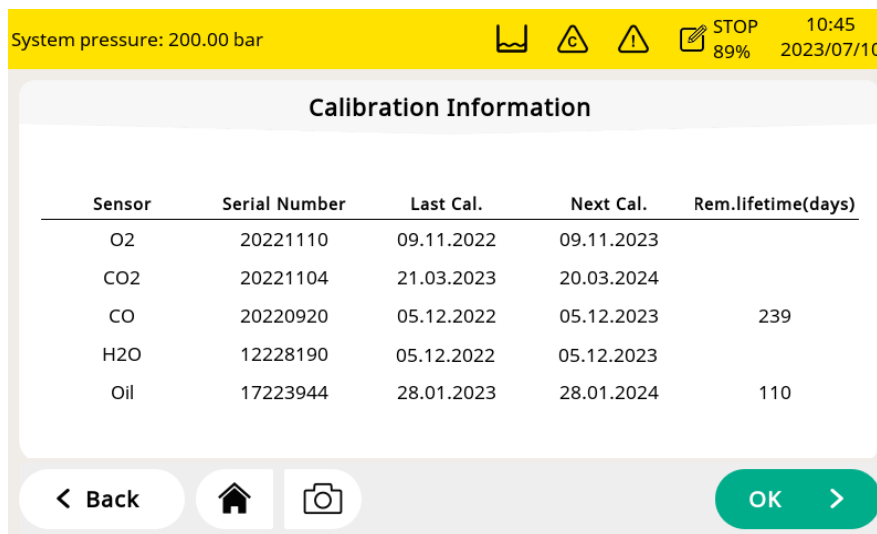

Sensor	Serial Number	Last Cal.	Next Cal.	Rem.lifetime(days)
O2	20221110	09.11.2022	09.11.2023	
CO2	20221104	21.03.2023	20.03.2024	
CO	20220920	05.12.2022	05.12.2023	239
H2O	12228190	05.12.2022	05.12.2023	
Oil	17223944	28.01.2023	28.01.2024	110

12.1 Calibration for DP Sensor and Oil Sensor

For the dew point sensor and oil sensor, the calibration operation is complicated and time consuming, so SUTO provides the exchange service, that is, the complete sensor unit is exchanged with a newly-calibrated unit. This saves time and costs.

12.2 Calibration for O₂, CO, CO₂ Sensor

The O₂ sensor, CO sensor, and CO₂ sensor can be calibrated on site or replaced with calibrated sensors using the exchange service of SUTO.



ATTENTION!

Please save all your measurement data on an external device before returning the instrument to calibration and service. It might be necessary to reset the displays storage during calibration and service.

12.2.1 Calibration Gases

Depending on the type of calibration, different calibration gases are used.

Zero gas

The zero gas is a test gas used for zero-point adjustment. The zero gas must be free from the measured gas or other substances that have cross-sensitivity.

Calibration and test gas

The span gas is a calibration gas used for sensitivity adjustment or verification of the calibration result. The span gas used can be the measured gas.

Here is recommended gases for the calibration and test gases:

Zero gas: 8%...12% O₂, N₂ background

Calibration gas O₂: 20%...24% O₂, N₂ background

Calibration gas CO: 16...20 ppm CO, N₂ background

Calibration gas CO₂: 800...1000 ppm CO₂, N₂ background

The test gas can be the ones in the middle. For example:

Test gas CO: 10 ppm CO, N₂ background(the calibration gas is 20 ppm CO)

Test gas CO₂: 500 ppm CO₂, N₂ background(the calibration gas is 1000 ppm CO₂)

Uncertainty of gases is 1% (K=2)



Attention!

Please select the suitable calibration gas, otherwise the sensor measurement accuracy will be affected.

12.2.2 Calibration Procedure

You can enter the calibration through **Menu > Calibration.**

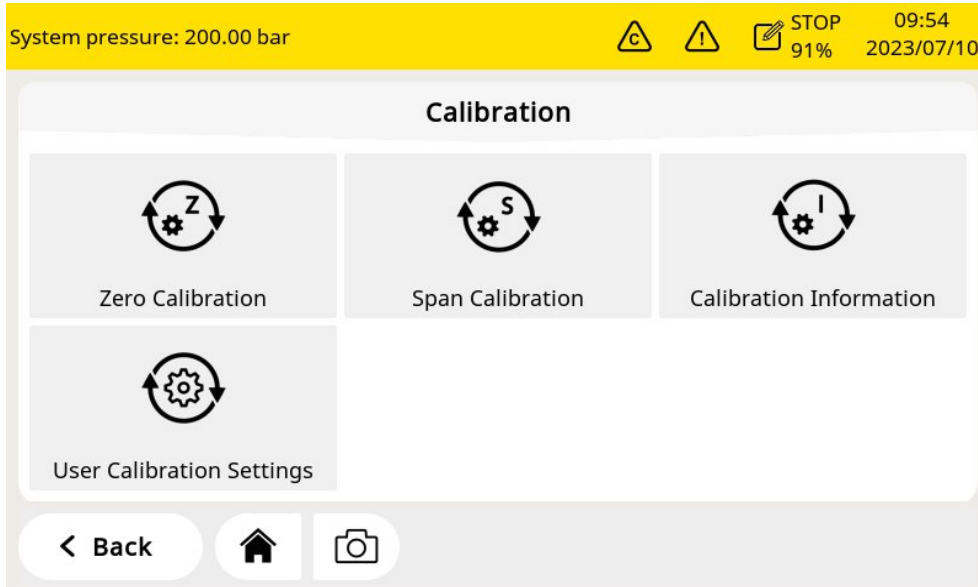

WARNING!

Do the calibration after the sensor is ready to work, for example the warm-up phase of the sensor is completed.

Do not inhale the calibration gas. It can be harmful to health or even death!

User Calibration Settings

The calibration reference data can be set before the calibration through **Menu > Calibration > User Calibration Settings**.

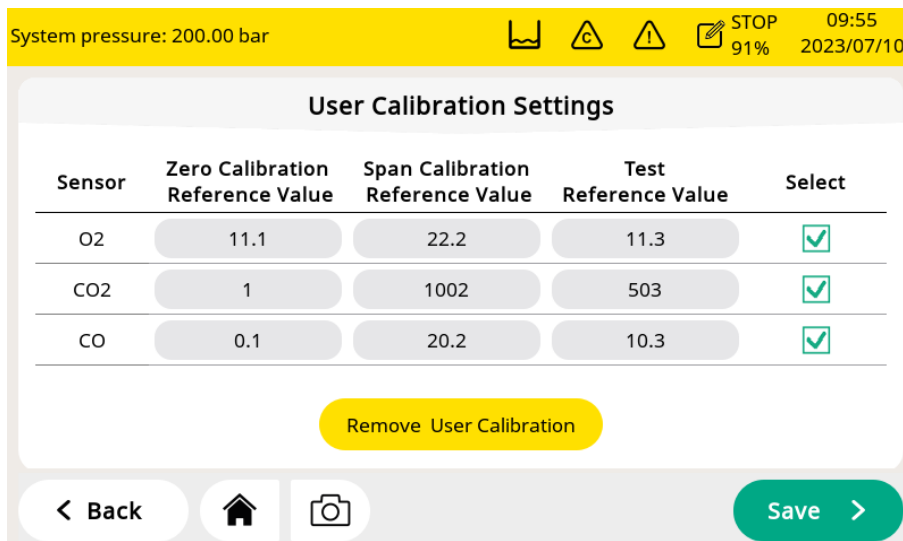

Zero calibration

Enter the zero calibration through **Menu > Calibration > Zero**

calibration.

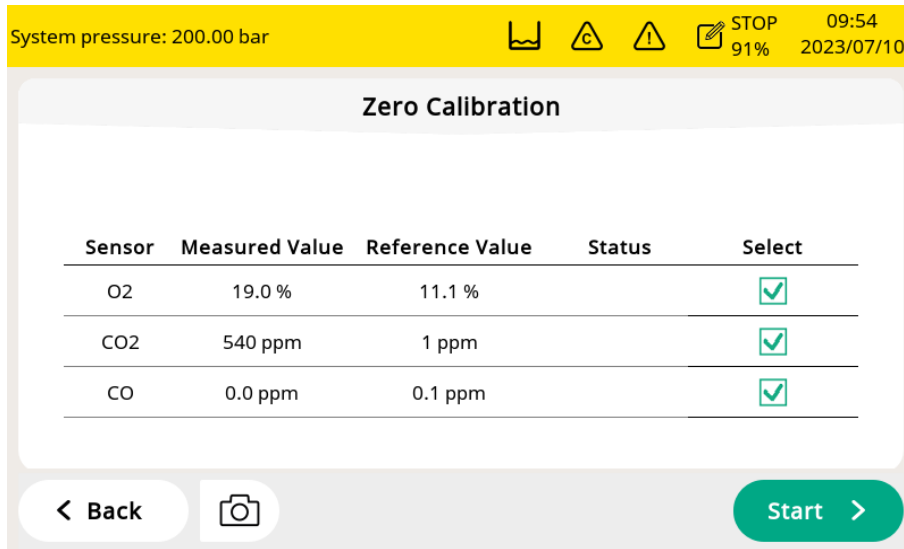

Span calibration

Enter the span calibration through **Menu > Calibration > Span calibration.**

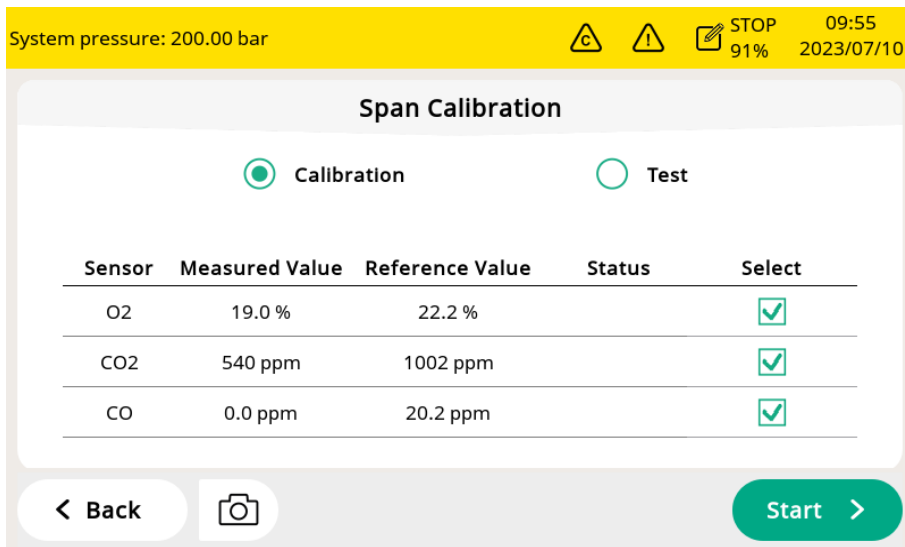

Zero/Span calibration procedures

1. Cut off air supply from main inlet.
2. Screw off the cap from calibration connector if not.
3. Connect the calibration hose from the gas cylinder to the calibration connector.
4. Adjust the flow controller at the gas cylinder to 0.5 l/min and the output pressure must 0 bar(g).
5. Select **Menu > Calibration > Zero/Span calibration.**

6. Select the sensor to be calibrated.
7. Supply zero/span gas. Make sure the flow rate of 0.5L/min.
8. Click **Start** button, and a progress bar will show with the calibration remaining time.
9. Zero/Span calibration takes nearly ten minutes. When the calibration is finished, you can check the calibration result in the **Status** field.
10. After the calibration is done, close the gas supply and remove the hose.

After the calibration, you can check the calibration result, by using another span gas. Just perform the same steps as above, but select the **test** in the span calibration menu.

Note:

It is recommended to test sensors using the standard gas every 3 months.

Please use the above steps to execute the test through **Menu > Calibration > Zero/Span calibration > Test**. When the test is finished, and the test result is passed, the sensor does not need to be re-calibrated. If the result is failed, it means that the accuracy of the sensor has been a big deviation, you need to re-calibrate the sensor immediately.

Calibration Records

You can check the calibration records through **Menu > Files > Calibration Records**.

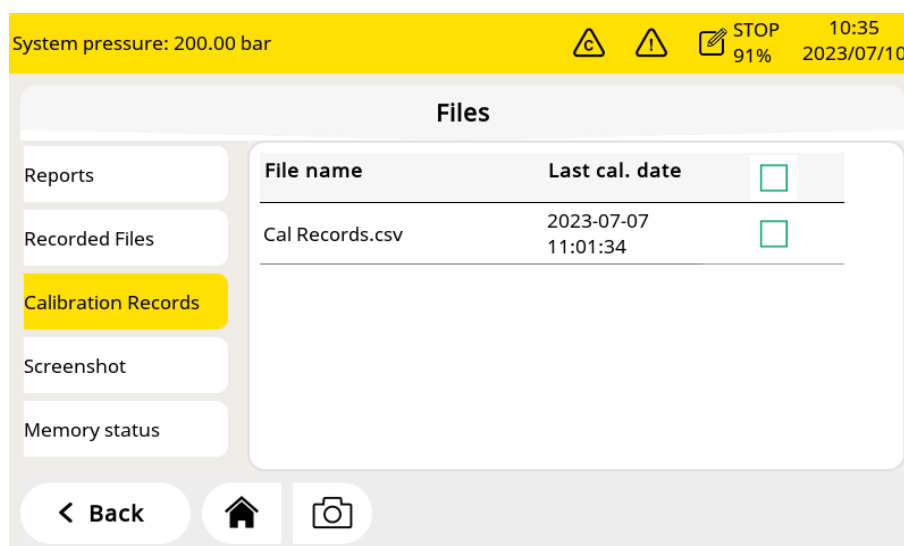



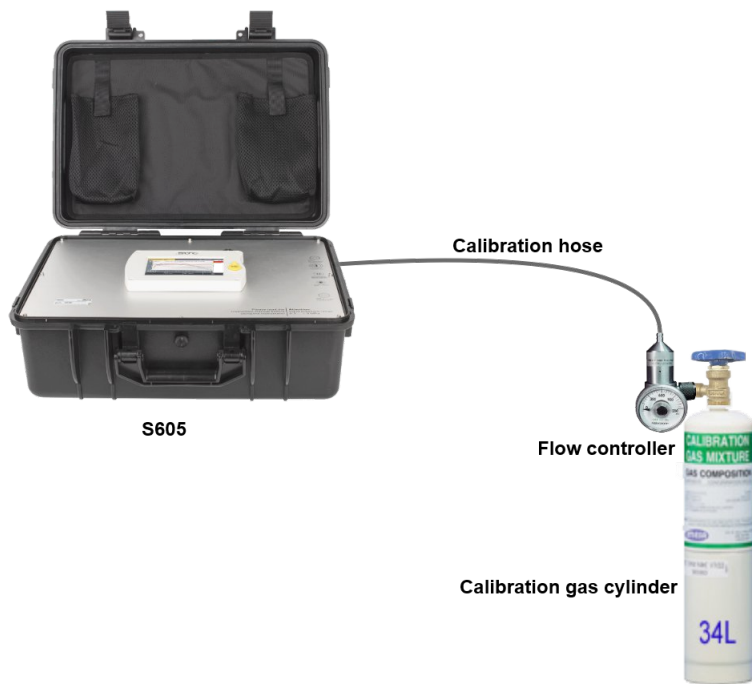

Example for calibration records file:

Calibration / Test Records								
S606 Breathing Air Quality Analyzer								
Item	Cal/Test	Sensor	Date	Reference value	Unit	Measured value Before calibration	Measured value After calibration	Status
1,	Cal,	O2 sensor,	2023.05.31,	11.0,	%	17.3,	17.3,	Failed
2,	Cal,	CO2 sensor,	2023.05.31,	500	ppm	1035,	1035,	Failed
3,	Cal,	CO sensor,	2023.05.31,	0.0,	ppm	0.0,	0.0,	Passed
4,	Cal,	O2 sensor,	2025.05.29,	11.0,	%	17.4,	17.4,	Failed
5,	Cal,	CO2 sensor,	2025.05.29,	0,	ppm	1020,	1026,	Failed
6,	Cal,	CO sensor,	2025.05.29,	0.0,	ppm	0.0,	0.0,	Passed
7,	<u>Kal.</u> ,	O2-Sensor,	2025.05.29,	11.0,	%	17.4,	17.4,	<u>Nicht</u>
8,	<u>Kal.</u> ,	CO2-Sensor,	2025.05.29,	0,	ppm	1020,	1030,	<u>Nicht</u>
9,	<u>Kal.</u> ,	CO-Sensor,	2025.05.29,	0.0,	ppm	0.0,	0.0,	<u>Bestanden</u>
10,	Cal,	O2 sensor,	2025.05.29,	11.0,	%	17.4,	17.4,	Failed
11,	Cal,	CO2 sensor,	2025.05.29,	500	ppm	1035,	1035,	Failed
12,	Cal,	CO sensor,	2025.05.29,	0.0,	ppm	0.0,	0.0,	Passed
7,	Cal,	O2 sensor,	2023.05.31,	11.0,	%	17.3,	17.3,	Failed
8,	Cal,	CO2 sensor,	2023.05.31,	500	ppm	1035,	1035,	Failed
9,	Cal,	CO sensor,	2023.05.31,	0.0,	ppm	0.0,	0.0,	Passed

The figure below is an example for the gas connection.



Here is the recommended supplier and accessories list:

Item	Brand	Description	Picture
Flow controller	MESA	Series 400 Fixed Flow Regulator ID:400-LPM	
Calibration Gas	MESA	Zero gas O ₂ : 11% O ₂ , N ₂ background O ₂ : 22% O ₂ , N ₂ background CO: 20 ppm CO, N ₂ background CO ₂ : 1000 ppm CO ₂ , N ₂ background 34L, steel calibration gas cylinders	
Test Gas	MESA	CO: 10 ppm CO, N ₂ background CO ₂ : 500 ppm CO ₂ , N ₂ background 34L, steel calibration gas cylinders	
Transport casing	MESA	Carrying cases ID:500	

Website: <https://mesagas.com/>

13 Optional Accessories

To purchase optional accessories, please contact the manufacturer or your local dealer:

- Teflon hoses and sorts of adapters
- USB 4G modem, including S4A software (P/N: A1670)
- Pressure reducer, including transport case (P/N: A604 0004)

14 Maintenance

The S605 must be serviced on a regular basis. It is recommended to do the following:

- Check the humidifier condition (See section 7.5.1).
- Test the sensor (See section 12.2.2).

Use a moist fabric to clean the device. For the use in GMP areas, the device must be disinfected through wipe disinfection. For more information, please contact the manufacturer or your local dealer.



ATTENTION!

Please dry the device after cleaning using a clean and dry fabric. Always take care, that the fabric for cleaning is not wet because water could get into the device and lead to damage.

15 Disposal or Waste



Electronic devices are recyclable material and do not belong in the household waste.

The sensor, the accessories and its packing must be disposed according to your local statutory requirements. The dispose can also be carried by the manufacturer of the product, for this please contact the manufacturer.

16 Warranty

Please find the warranty as a separated warranty card included with the instrument delivery.

The warranty does not cover any wear parts or consumables, therefore the UV lamp with limited lifetime as well as the internal filter are not covered by the warranty.

17 Appendix - Modbus Holding Register Table

17.1 Modbus Interface

The default settings of the Modbus interface are as follows:

Communication parameters (Modbus/RTU)

Baud rate	: 19200
Device address	: Last two digits of serial number
Framing / parity / stop bit	: 8, N, 1
Response time	: 1 second
Response delay	: 0 ms
Inter-frame spacing	: 7 char

Communication parameters (Modbus/TCP)

DHCP	: Yes
MAC	: Set ex-factory
IP address	: Dynamic or Static
Subnet	: Dynamic or Static
Gateway	: Dynamic or Static
Timeout	: ≥ 200 ms

Response message that the device returns to the master:

- Function code: 03

The information of the byte order is shown in the table below:

Byte Order	Sequence				Data Type
	1st	2nd	3rd	4th	
1-0-3-2	Byte 1 (MMMMMMMM*)	Byte 0 (MMMMMMMM *)	Byte 3 (SEEEEEEE)	Byte 2 (EMMMMMMM *)	FLOAT
1-0-3-2	Byte 1	Byte 0 LSB	Byte 3 MSB	Byte 2	UINT32 INT32
1-0	Byte 1 MSB	Byte 0 LSB	---	---	UINT16 INT16
1-0	Byte 1 XXX *	Byte 0 DATA	---	---	UINT8 INT8

* S: Sign, E: Exponent, M: Mantissa, XXX: no value

Explanations of MSB and LSB

- MSB** MSB refers to Most Significant Byte first, which follows the Big-Endian byte order.
 For example, if the main system follows the MSB first order:
 When the 4-byte floating number, in the order of Byte1-Byte0-Byte3-Byte2, is received from the slave (sensor), the master must change the byte order to Byte3-Byte2-Byte1-Byte0 for the correct display of the value.
-
- LSB** LSB refers to Least Significant Byte first, which follows the Little-Endian byte order.
 For example, if the main system follows the LSB first order:
 When the 4-byte floating number, in the order of Byte1-Byte0-Byte3-Byte2, is received from the slave (sensor), the master must change the byte order to Byte0-Byte1-Byte2-Byte3 for the correct display of the value.

17.2 Modbus Register Table

The following table lists specifications of the Modbus output channels in this device.

Holding register	Data type	Data Length	Channel Description	R/W	Remark
Common System Information					
2000	INT16U	2-Byte	Group ID (=6)	R	Gas flow sensor, water flow etc.
2001	INT16U	2-Byte	Device ID	R	Unique identification
2002	INT32U	4-Byte	Serial number	R	Factory S/N
2004	INT16U	2-Byte	High = 0xFF, Low byte HW version	R	Before it was SW version in High Byte, but in future there will be a 3 BYTE version and the High Byte is set to 0xFF
2005	DOUBLE	8-Byte	Calibration date	R	Date time (8-bytes) format is time-variant (Microsoft)
2009	INT16U	2-Byte	Valid days from calibration date	R	
2010	INT16U	2-Byte	Number of Measuring Channels	R	1 ... 96
2011	STRING	16-Byte	Device description	R/W	"S605" etc.
2019	INT16U	2-Byte	Version of Modbus Definition	R	0x0201 = 02.01
2020	INT16U	2-Byte	Version of this register table	R	Start from 0x100 = 1.00

2021	INT32U	4-Byte	Calibration date	R	unix time format
2023	INT32U	4-Byte	Production date	R	unix time format
2025	INT32U	4-Byte	FW version (low 3 Bytes used)	R	New firmware version format: XX.XX.XX
2027	STRING	16-Byte	Device Location	R/W	User can enter a text
2035	STRING	16-Byte	Measurement Point	R/W	User can enter a text
2043	INT16U	2-Byte	Number of sensors	R	How many and which SUTO sensors are connected to the main unit. Their settings are found from 10000 up.
Modbus/RTU Settings					
2100	INT16U	2-BYTE	Write Password	W	Response: 0 → access permitted 1 → authorization required password: 0XA5A5
2110	INT16U	2-Byte	Modbus baud rate index 0---1200 1---2400 2---4800 3---9600 4---19200 5---38400 6---57600 7---115200	R/W	
2111	INT16U	2-Byte	Modbus parity	R/W	
2112	INT16U	2-Byte	Modbus stop bit	R/W	
2113	INT16U	2-Byte	Device Address	R/W	
Modbus/TCP Settings					
2120	INT32U	4-Byte	Static IP address	R/W	
2122	INT16U	2-Byte	Portal number	R/W	
2123	INT32U	4-Byte	Subnet mask	R/W	
2125	INT16U	2-Byte	DHCP enabled	R/W	
2126	INT32U	4-Byte	IP address	R	For DHCP only
Measurement Channel Information					
2200	INT16U	2-Byte	O2 : unit+resolution+type	R	These are the fix information that doesn't need to be read frequently.
2201	INT16U	2-Byte	CO2 : unit+resolution+type	R	
2202	INT16U	2-Byte	CO : unit+resolution+type	R	
2203	INT16U	2-Byte	H2O : unit+resolution+type	R	

2204	INT16U	2-Byte	Oil: unit+resolution+type	R	
2205	INT16U	2-Byte	Pressure: unit+resolution+type	R	
2206	INT16U	2-Byte	Temp.: unit+resolution+type	R	
2207	INT16U	2-Byte	Humidity Gas Sensor: unit+resolution+type	R	
Measurement Channel Status and Values					
2301	FLOAT	4-Byte	Channel Value O2	R	Status information, with 2 bits: 00 all OK 01 Out of range 10 Sensor broken 11 Other error
2303	FLOAT	4-Byte	Channel Value CO2	R	
2305	FLOAT	4-Byte	Channel Value CO	R	
2307	FLOAT	4-Byte	Channel Value H2O	R	
2309	FLOAT	4-Byte	Channel Value Oil	R	
2311	FLOAT	4-Byte	Channel Value Pressure	R	
2313	FLOAT	4-Byte	Channel Value Temperature	R	
2315	FLOAT	4-Byte	Channel Value Humidity Gas	R	
Device specific System Information for S605					
					Bit1 bit0(water level): 00: normal 01: low level indicator 10: high level indicator 11: N/A
2600	INT32U	4-Byte	General System status	R	Bit 2: O2 Bit 3: CO2 Bit 4: CO Bit 5: H2O Bit 6: Oil Bit 7: Pressure Bit 8: temperature Bit 9: Humidity for Gas . 0: normal 1: calibration overdue.
2602	INT32U	4-Byte	Alarm status 1: Bit 0-1: O2 Bit 2-3: CO2 Bit 4-5: CO Bit 6-7: H2O Bit 8-9: Oil Bit 10-11:Pressure Bit 12-13: Temp. Bit 14-15: Humidity Gas Bit 16-32: reserved for future	R	2 bits for alarm status: 00: no alarm 01: High alarm 10: Low alarm 11: N/A In Total 16 alarm status
2604	FLOAT	4-Byte	Total work time	R	The total operating

					time since delivery
2606	FLOAT	4-Byte	Minimum value O2	R	Only can be reset with default setting.
2608	FLOAT	4-Byte	Maximum value O2	R	
2610	FLOAT	4-Byte	Minimum value CO2	R	
2612	FLOAT	4-Byte	Maximum value CO2	R	
2614	FLOAT	4-Byte	Minimum value CO	R	
2616	FLOAT	4-Byte	Maximum value CO	R	
2618	FLOAT	4-Byte	Minimum value H2O	R	
2620	FLOAT	4-Byte	Maximum value H2O	R	
2622	FLOAT	4-Byte	Minimum value Oil	R	
2624	FLOAT	4-Byte	Maximum value Oil	R	
2626	FLOAT	4-Byte	Minimum value pressure	R	
2628	FLOAT	4-Byte	Maximum value pressure	R	
2630	FLOAT	4-Byte	Minimum value temperature	R	
2632	FLOAT	4-Byte	Maximum value temperature	R	
2633	FLOAT	4-Byte	Minimum value humidity gas	R	
2635	FLOAT	4-Byte	Maximum value humidity gas	R	
2637	FLOAT	4-Byte	Minimum value barometer	R	
2639	FLOAT	4-Byte	Maximum value barometer	R	

Notes: For any settings (write operation) the password needs to be entered into address 2100 at first. After restart all write operations are disabled by default.

17.3 Unit and Resolution

The first byte is for unit.

Bit7	Bit6	Bit5	Bit4	Bit3	Bit2	Bit1	Bit0
Data type: UINT32				Unit: 1 °C 2 °F 7 mg/m ³ 36 MPa 38 bar 39 psi 109 % 110 ppm 149 °C Td (PDP) 150 °C Td (ADP) 151 ml/m ³ 152 °F Td (PDP) 153 °F Td (ADP)			

The second byte is for resolution.

Bit7	Bit6	Bit5	Bit4	Bit3	Bit2	Bit1	Bit0
Data type:				Resolution:			
0 FLOAT				0 0			
1 UINT32				1 0.0			
2 DOUBLE				2 0.00			
3: UINT16 [0 to 65535]				3 0.000			
4: INT16 [-32768 to 32767]				4 0.0000			
5: INT32 [-2147483648 to 2147483647]							
6: INT64 [-9223372036854775808 to 9223372036854775807]							

SUTO iTEC GmbH

Grißheimer Weg 21
D-79423 Heitersheim
Germany

Tel: +49 (0) 7634 50488 00
Email: sales@suto-itec.com
Website: www.suto-itec.com

SUTO iTEC (ASIA) Co., Ltd.

Room 10, 6/F, Block B, Cambridge Plaza
188 San Wan Road, Sheung Shui, N.T.
Hong Kong

Tel: +852 2328 9782
Email: sales.asia@suto-itec.com
Website: www.suto-itec.com

SUTO iTEC Inc.

5460 33rd St SE
Grand Rapids, MI 49512
USA

Tel: +1 (616) 800-7886
Email: sales.us@suto-itec.com
Website: www.suto-itec.com

All rights reserved ©

Modifications and errors reserved

S605_IM_EN_V2025-3.odt