

Instruction and Operation Manual

S335

IoT Gateway



Dear Customer,

Thank you for choosing our product.

Before you start up the device, please read this manual in full and carefully observe instructions in this manual. The manufacturer cannot be held liable for any damage that occurs because of non-observance or non-compliance with this manual.

Should the device be tampered with in any manner other than a procedure described and specified in the manual, the warranty is void and the manufacturer is exempt from liability.

The device is destined exclusively for the described application.

SUTO iTEC offers no guarantee of suitability for any other purpose. SUTO iTEC is also not liable for consequential damage resulting from the delivery, capability or use of this device.

Revision: 2025-2



Last modifications: March, 2025

Table of Contents

1	Safety Instructions.....	5
2	Registered Trademarks.....	6
3	Applications.....	7
4	Features	7
5	Technical Data.....	8
	5.1 General Data.....	8
	5.2 Electrical Data	8
	5.3 Input Signals	8
	5.4 Output Signals.....	8
6	Dimension.....	9
7	Installation	10
	7.1 Installation Requirements.....	11
	7.2 Install the S335.....	11
8	Electronic Connection.....	13
	8.1 Introduction	13
	8.2 Pin Assignment.....	14
	8.2.1 5-Pin M12.....	14
	8.2.2 4-Pin M12.....	15
	8.3 LED Indicators.....	15
9	Operation on the Display.....	16
	9.1 Information on the Display.....	16
	9.2 Icons in the Status Bar.....	18
	9.3 Alarm and Error Code.....	18
	9.4 Update S335 Firmware.....	18
	9.4.1 Update Firmware via a USB-C Stick.....	19
	9.4.2 Update Firmware via S4C-Web.....	19
10	Configuration using S4C-Web.....	20
	10.1 Establish Communication between the S335 and S4C-Web.....	21
	10.1.1 Connect via Direct Ethernet Cable.....	21
	10.1.2 Connect through a LAN.....	23
	10.2 Username and Role.....	24
	10.3 Change Password and Language	24
	10.3.1 Change Password.....	25
	10.3.2 Reset Password.....	25
	10.3.3 Change Language.....	25
	10.4 Sensor Settings.....	26
	10.4.1 Add SUTO iTEC Sensors.....	26
	10.4.2 Add 3rd Party Sensors.....	28
	10.4.3 Assign Channels to Measurement Location and Point.....	30
	10.5 Communication Settings.....	31
	10.5.1 4G Settings.....	32

10.5.2 Ethernet Settings.....	33
10.5.3 Modbus Setting.....	35
10.5.4 S4M SaaS Settings.....	36
10.5.5 Export Holding Register.....	36
10.6 System.....	37
10.6.1 System Information.....	37
10.6.2 Date/Time Setting.....	37
10.6.3 Firmware Update	37
10.6.4 Import/Export Configuration File.....	38
11 Maintenance.....	38
12 Disposal or Waste.....	38
13 Appendix – Modbus Interface.....	39

1 Safety Instructions

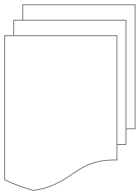

Please check if this instruction manual matches the product type.

Please observe all notes and instructions indicated in this manual. This manual contains essential information that must be observed before and during installation, operation, and maintenance. Therefore, this manual must be read carefully by the technician as well as by the responsible user or qualified personnel.

This instruction manual must be available at the operation site of the product at any time. In case of any obscurities or questions regarding this manual or the product, please contact the manufacturer.

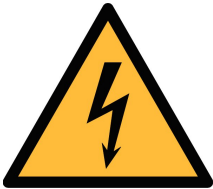

WARNING!

Voltage used for supply!

Any contact with energized parts of the product, may lead to an electrical shock which can lead to serious injuries or even death!

- Consider all regulations for electrical installations.
- The system must be disconnected from any power supply during maintenance work.
- Any electrical work on the system is only allowed by authorized qualified personnel.

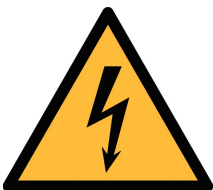

WARNING!

Permitted operating parameters!

Observe the permitted operating parameters, any operation exceeding these parameters can lead to malfunctions and may lead to damage to the instrument or the system.

- Do not exceed the permitted operating parameters.
- Make sure the product is operated on its permitted limitations. Store and operate the product at the permitted temperature and pressure.

General safety instructions

- It is not allowed to use the product in explosive areas.
- Please observe the national regulations before/during installation and operation.

Remarks

- It is not allowed to disassemble the product.



ATTENTION!

Measurement values can be affected by malfunction!

The product must be installed properly and frequently maintained, otherwise, it may lead to wrong measurement values, which can lead to wrong results.

Storage and transportation

- Make sure that the transportation temperature of the device is between -20°C ... $+60^{\circ}\text{C}$.
- For transportation it is recommended to use the packaging which comes with the device.
- Please make sure that the storage temperature of the device is between -20°C ... $+70^{\circ}\text{C}$.
- Avoid direct UV and solar radiation during storage.
- For storage the humidity must be $<90\%$ with no condensation.

2 Registered Trademarks

Trademark	Trademark owner
SUTO®	SUTO ITEC
MODBUS®	Modbus Organization, Hopkinton, USA
Android™, Google Play	Google LLC

3 Applications

The S335 IoT gateway serves as a central hub for IoT devices. It helps to connect devices to the cloud and ensures that they can communicate with each other. It also filters the collected data and converts it into useful information.

The S335 works well with platforms such as SUTO iTEC S4M SaaS and various sensors. Equipped with a built-in web server, the S335 can easily manage and set up both SUTO iTEC sensors and sensors from other manufacturers via a user-friendly, browser-based interface (the S4C web interface). In this way, everything can be configured without additional software.

4 Features

- Connects all SUTO iTEC and third-party sensors.
- Configure the S335 via the user-friendly browser-based S4C-Web, no additional software required.
- Enables remote retrieval of measured values when an optional 4G/LTE modem is installed.
- Avoids duplication of work by exporting or importing the same configuration file to the S335.
- Can be connected to factory automation systems with the RS-485 (Modbus/RTU) or Ethernet (Modbus/TCP) interface.
- Provides 65 W sensor power supply (24 VDC).
- Supports up to 80 measuring channels.
- Enables remote monitoring with the integrated web server.
- Supports wall mounting and DIN rail mounting.

5 Technical Data

5.1 General Data

CE	
Operating temperature	0 ... +50°C
Housing material	PC+ABS
Protection class	IP65
Dimensions	124 x 102 x 70 mm
Display	2.4" color (640 x 480) graphic display, 1 touch button
Weight	0.4 kg

5.2 Electrical Data

Power supply	24 VDC, 7 W ... 72 W
Sensor supply	24 VDC, up to 65 W (depending on supply)

5.3 Input Signals

Digital input	16 x RS-485 Modbus/RTU Sensors Modbus/TCP
---------------	--

5.4 Output Signals

Interface	Ethernet (Modbus/TCP), RS-485 (Modbus/RTU), USB-C port
-----------	--

6 Dimension

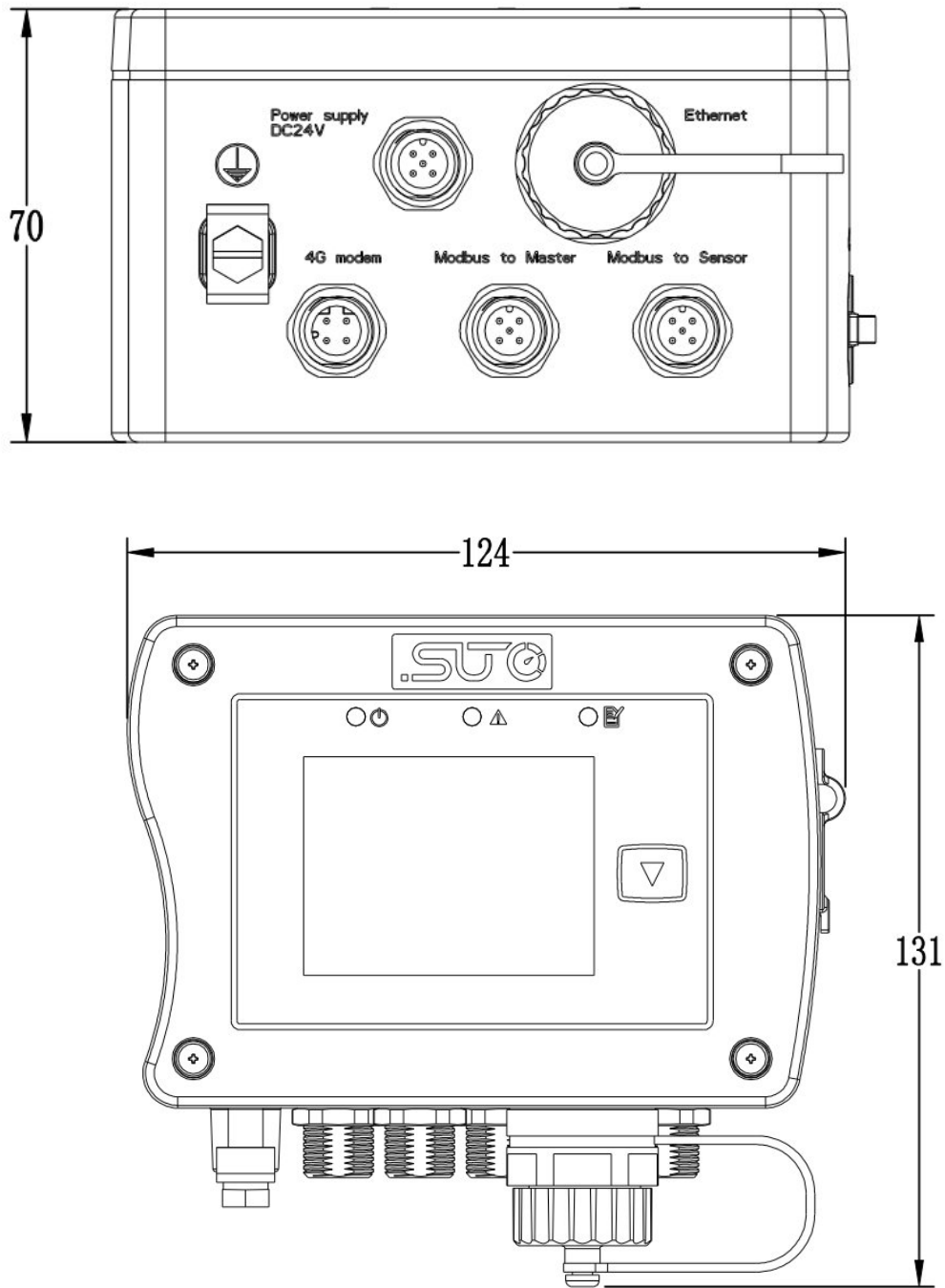

7 Installation

Make sure that all components listed below are included in your package.

Qty	Description	Item No.
1	S335 IoT Gateway with display, Modbus/RTU (RS-485), Modbus/TCP (Ethernet), USB-C, M12 connector for 4G modem, M12 connectors for Sensors, Power supply and RS-485 Supply: 24 VDC min.7 W / max. 72 W (up to 65 W supply to sensors)	D500 0336
1	No mounting	A4602
	or Wall mounting plate	A4603
	or 35 mm DIN hat rail mounting plate	A4604
1	Instruction manual	No P/N

The following accessories are available for you to choose from.

Item No.	Description
Cables	
A553 0104	Sensor cable 5 m with M12 connector, open ends, 5 poles, AWG 24 (0.2 mm ²)
A553 0105	Sensor cable 10 m with M12 connector, open end, 5 poles, AWG 24 (0.2 mm ²)
A553 0165	Sensor cable, 5 poles, AWG24 (0.2 mm ²), 50 m
A553 0166	Sensor cable, 5 poles, AWG24 (0.2 mm ²), 100 m
A553 0167	RS-485 (Modbus) cable, 4-pole twisted pairs with shield, AWG24 (0.2 mm ²), 50 m reel
A553 0168	RS-485 (Modbus) cable, 4-pole twisted pairs with shield, AWG24 (0.2 mm ²), 100 m reel
A554 3310	M12-Splitter, for Modbus Daisy chain wiring, including 2 x M12 plug
C219 0055	M12 connector with RS-485 termination resistor (120 Ω) , for Modbus daisy chain termination
Converters and gateways	
A554 0011	RS-485 repeater

A554 0331 RS-485 / USB converter

4G Modem for remote connection

A1670 USB 4G dongle, excl. SIM card

A554 0131 Wall casing for USB 4G dongle, with 2m cable and M12 connector

7.1 Installation Requirements

- The S335 is for indoor use only! In the event of an outdoor installation, the device must be protected from sunlight and rain.
- It is strongly recommended not to install the S335 permanently in a damp environment, such as the compressor outlet.

7.2 Install the S335

The S335 can either be mounted on a wall or on a hat rail when ordered with the optional wall plate or DIN hat rail mounting plate.



ATTENTION!

Wrong measurement is possible if the S335 is not installed correctly.

Installation steps:

1. Install the S335 at the designated location. Optional accessories are available for mounting the S335 on a wall or on a DIN hat rail.

Mount on the wall

The mounting plate must be fixed on the wall using suitable dowels and screws.

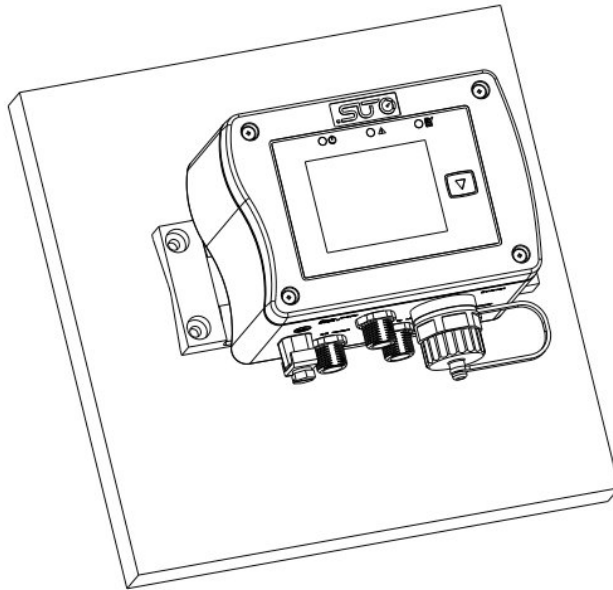
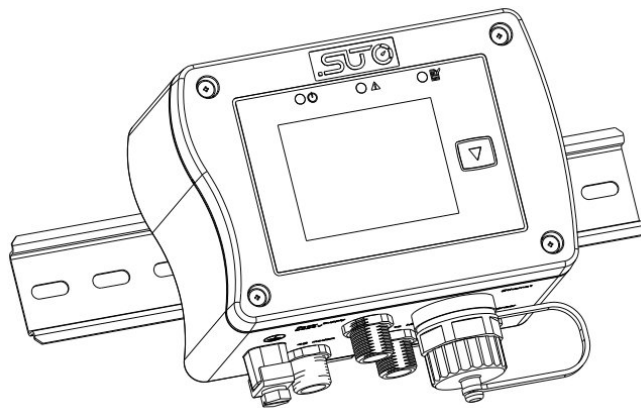
**Mounted on a DIN hat rail**



2. Connect the relevant devices as described in the section 8 Electronic Connection.
3. Connect the ground terminal to the earth if the S335 is operated in an environment with high electrical interference.

8 Electronic Connection

8.1 Introduction

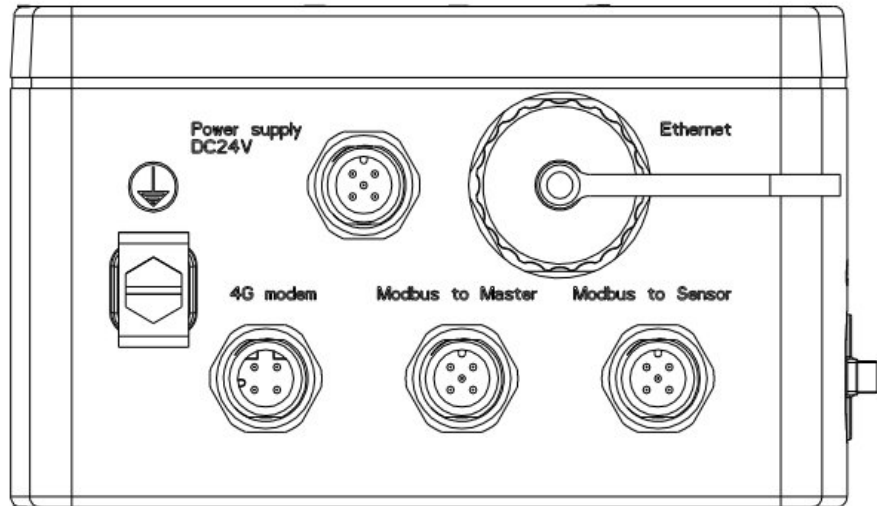
Connectors on the S335 for external connections are shown in the figure on the right.



Name	Type	Function
Power Supply DC24V	5-pin M12	24 VDC, min. 7 W / max. 72 W up to 65 W supply to sensors
4G Modem	4-pin M12	Connection of the optional 4G modem.
Modbus to Master	5-pin M12	Modbus/RTU output - Connect the S335 to a higher-level system/software.
Modbus to Slave	5-pin M12	Modbus/RTU input - Connect Modbus/RTU Slaves/Sensor to the S335.
	Earth terminal	When the S335 is operating in an environment with high electrical interference, it is recommended to connect the terminal to the earth.
	USB-C	USB port for the S335 firmware update.
Ethernet	RJ-45	The Ethernet port used for several purposes. <ol style="list-style-type: none"> 1. Configure the S335 via the S4C-Web. 2. Connect to the S335 to read live values via the S4C-Web. 3. Modbus/TCP communication (Slave) The S335 has 2 different modes for different network connections: operation mode and configuration mode.

- Operation mode:** The S335 is in this mode after start-up. After configuration, the S335 remains in this mode. When the S335 connects to the local network, it automatically retrieves an IP address via DHCP. When the S335 has received an IP address, it can be accessed via the S4C-Web interface. This facilitates connection and configuration after switching on. If the network is not available, you can switch the S335 from operation mode to configuration mode to configure the S335.
- Configuration mode:** This mode is used for configuration only. After the configuration is done, you must exit this mode. In this mode, the S335 acts as its own DHCP server, assigning an IP address to the directly connected PC. You can connect to the S335 using a LAN cable by entering the fixed IP address 192.168.8.8. In this way, the PC can be connected to the S335 directly via a LAN cable for configuration.

Note: In this mode, do not connect S335 to the local network. Otherwise, the integrated DHCP server can change IP addresses of devices in the network. This results in other devices in the same network no longer functioning correctly.

8.2 Pin Assignment

8.2.1 5-Pin M12

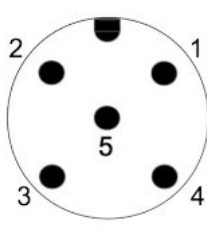
 <p>5-pin M12, male, view onto the connector</p>	Connector	Pin	Function	Description
	Modbus to Master	1	GND _M	Ground for Modbus/RTU
		2	-V _B	Negative supply voltage
		3	+V _B	Positive supply voltage
		4	D+	Modbus/RTU data +
		5	D-	Modbus/RTU data -
	Modbus to Slave	1	GND _S	Ground for Modbus/RTU
		2	-V _B	Negative supply voltage
		3	+V _B	Positive supply voltage
		4	D+	Modbus/RTU data +
		5	D-	Modbus/RTU data -
	Power supply	1	NA	NA
		2	-V _B	Negative supply voltage
		3	+V _B	Positive supply voltage
		4	NA	NA
5		NA	NA	

8.2.2 4-Pin M12

 <p>4-pin M12, male</p>	Connector	Pin	Function	Description
	4G modem	1	V _{BUS}	Positive supply voltage
		2	D-	USB data -
		3	D+	USB data +
4		GND	Negative supply voltage	





ATTENTION!

Do not screw the M12 connector using force. Otherwise, it might damage the connecting pins.

8.3 LED Indicators

Three LED indicators are on the S335 panel. Two of them are available.

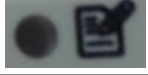
LED	Function	LED on	LED off
	24 VDC Power supply	S335 is powered on.	S335 is powered off.
	Error status indication	An error occurs. *	No error occurs.
	N/A	N/A	N/A

* The status and their error codes are described in the section 9.3 Alarm and Error Code.

9 Operation on the Display

Operation the S335 is simple as only a few steps are required after switching on the S335. Operations include the following:

- View information, such as connected devices, the S335 information, IP address etc.
- Update the S335 firmware.
- Switch the S335 mode from the operation mode (DHCP client) to configuration mode (DHCP server) to configure the S335 directly with the PC via a LAN cable..

Note: The language on the S335 display can be set to English, Chinese, or German via the S4C-Web.

9.1 Information on the Display

The S335 displays a total of 6 pages of information and press  to go into the next page.

Note: The pages below can only be seen when the S335 is in the operation mode.

10:30 P 1/6	
Status Info	
Modbus/RTU:	OK

Page 1, home page, displays the status Info.

Note: When an alarm occurs, the error code is shown. See section 9.3 for details.

10:30 P 2/6	
Connected Devices	
RTU Sensors:	5
Channels:	20

Page 2 displays information about the connected devices.

10:30 P 3/6	
Device Info	
Oder Number:	D500 0336
Serial Number:	1624 6066
Firmware Version:	1.00
Hardware Version:	1.00

Page 3 displays the S335 information.

10:30 P 4/6	
Modbus/RTU	
Master Baud Rate:	19200
Timeout(s):	10
Slave Baud Rate:	115200
Address:	1

Page 4 displays information of Modbus/RTU settings.

10:30 P 5/6	
IP Config	
DHCP: YES	MAC: 40:d8:55:05:10:18
IPv4:	192.168.000.040
Subnet:	255.255.255.000
Gatway:	192.168.000.001

Page 5 displays the IP information and settings of the S335.





10:30 P 6/6	
Configuration	
<p>This allows the S335 to act as a DHCP server and connect directly to a PC via Ethernet cable. Press and hold the button to enter configuration mode.</p>	

Page 6 displays the configuration mode information.

The configuration mode is used to establish a direct connection between the S335 and your PC for configuration when the S335 cannot access a LAN. For details, see the section 10.1 Establish Communication between the S335 and S4C-Web.

Note: If the screen remains inactive for 3 minutes, it will revert to the first page. Following an additional 15 minutes of inactivity, the screen will turn black. Press  to wake it up.

9.2 Icons in the Status Bar

	Cellular signal strength		USB stick connected
	Both cellular and Internet connected		System error
	Connected to S4M SaaS		

9.3 Alarm and Error Code

When an alarm is raised, the corresponding error code displays on the **Status Info** page.

All error codes associated with alarms and their respective definitions are as follows.

Error code	Description
0x00000001	Disk full
0x00000002	RS-485 communication lost
0x00000008	USB format is not FAT32
0x00000100	No 4G SIM card
0x00000200	APN cannot be verified
0x00000400	4G call failed

Note: If multiple alarms are raised, only one error code is displayed, and the error code is the sum of all the alarms triggered.

You can view the alarm descriptions by pressing and holding the  button on the S335.

When all alarms are cleared, the error code is no longer shown.

9.4 Update S335 Firmware

The S335 firmware file is named with .suto as suffix. Two ways are available to update the S335 firmware.

- Update via a USB-C stick by connecting it to S335 directly.
- Update through the S4C-Web by connecting your PC to the S335, whatever the S335 in the configuration mode or operation mode.

9.4.1 Update Firmware via a USB-C Stick

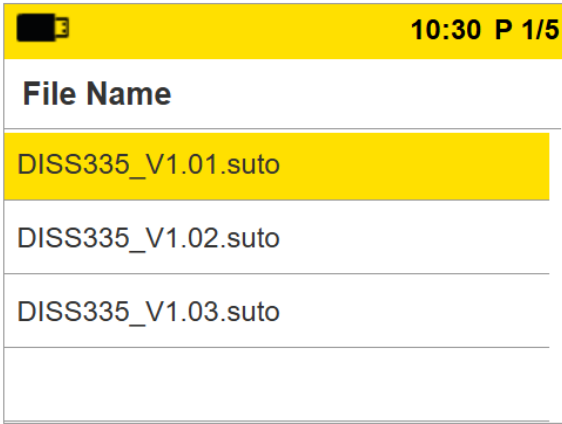

Follow steps below to update the S335 firmware.

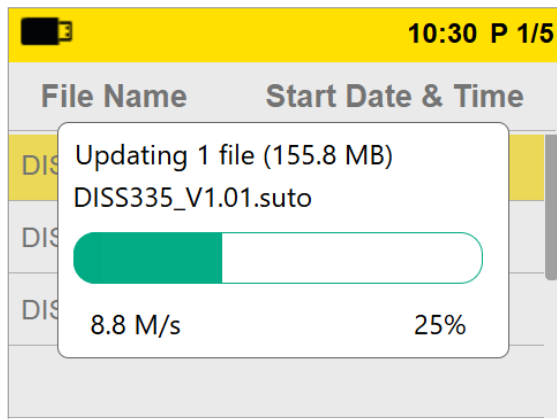

1. Insert the USB-C stick into the S335, then the firmware files with the .suto suffix are displayed automatically.

Note: The firmware files must be saved in the root directory of the USB stick. Otherwise, they will not be displayed.



2. Click the  button to select the specific firmware file; hold the  button to confirm the update.

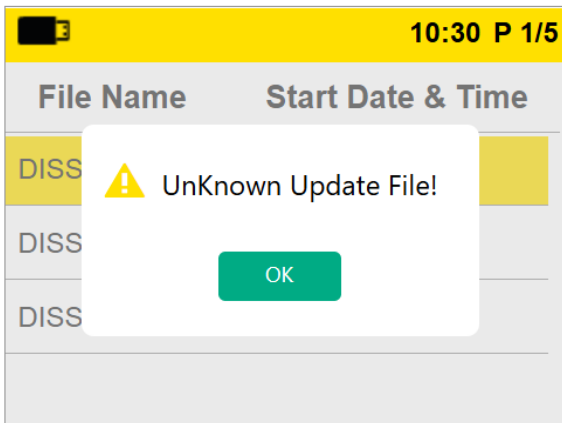

If you select a wrong firmware file, the S335 will pop up with a warning message.

Click  to cancel the update.

Note: The format of the USB stick must be FAT32. Otherwise, an alarm occurs.

9.4.2 Update Firmware via S4C-Web

Users can update the S335 firmware via the S4C-Web too. For details, see section 10.6.3 Firmware Update .

10 Configuration using S4C-Web

The S335 cannot automatically identify connected sensors. You need to use the S4C-Web to configure sensors. The S4C-Web is web browser-based software, and you do not need to install any software on your PC. You can use any web browser by inputting the IP address of the S335 to do configurations.

The figure below describes the general procedure of configurations via the S4C-Web.

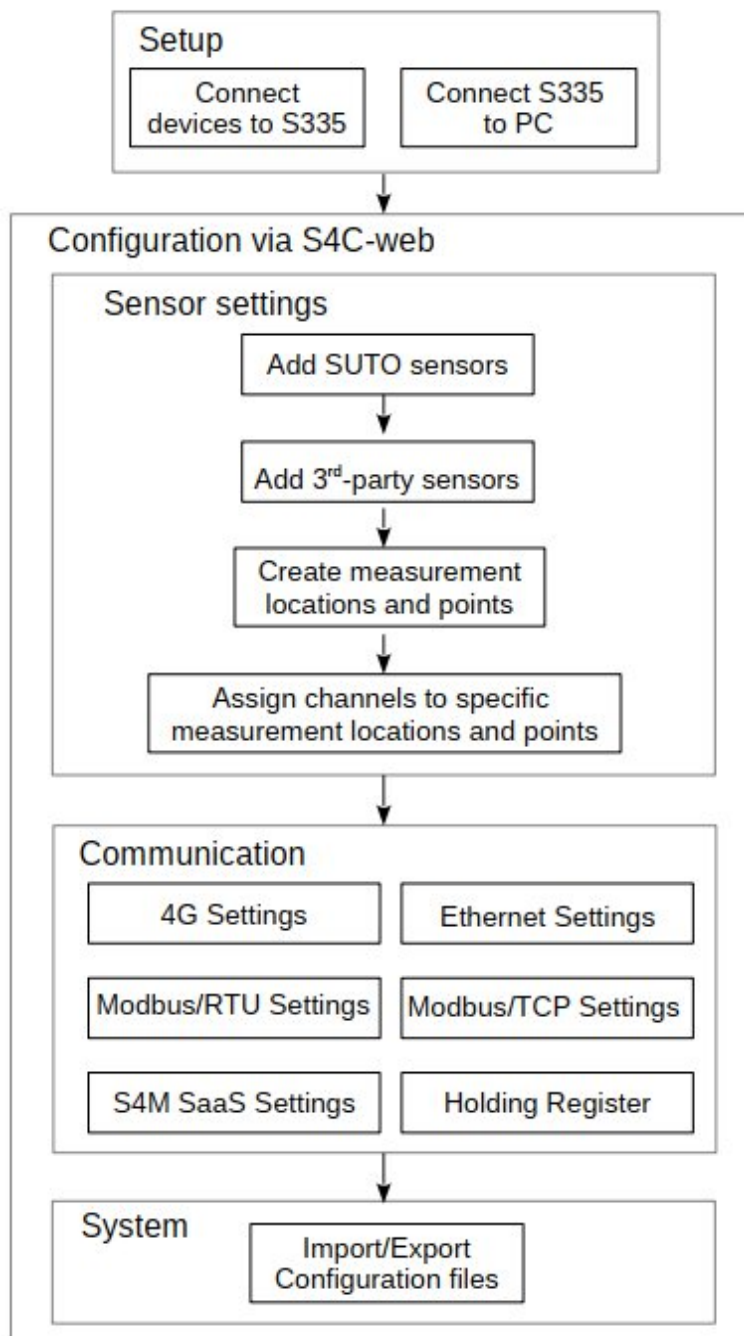

This section introduces the steps required to set up and configure the S335, including the following:

- Establish communication between the S335 and the S4C-Web.
- Log into the S4C-Web.
- Perform Sensor Settings.
- Perform Communication settings.
- Export the holding register table.
- Import/Export configuration files.
- Perform other settings.

10.1 Establish Communication between the S335 and S4C-Web

Before configuring on the S4C-Web, you need to establish communication between the S335 and the S4C-Web. For the purpose, the following software and hardware are required:

- A PC with Windows 10 or Windows 11, and a web browser installed
- A USB-C to RJ-45 converter (included in the S335)
- An Ethernet cable to connect the S335 to your PC (included in the S335)

Two ways are available to establish communication:

- Connect via a direct Ethernet cable.
- Connect over a LAN network.

10.1.1 Connect via Direct Ethernet Cable

1. Power on the S335.
2. Connect your PC to the S335 directly via the Ethernet cable supplied.
3. Change the S335 from the operation mode (default mode) to the configuration mode.
4. Log on to the S4C-Web by entering the S335 IP address, which is the fixed IP 192.168.8.8.

Follow steps below to switch the S335 to the configuration mode.





Configuration

This allows the S335 to act as a DHCP server and connect directly to a PC via LAN.
Press and hold the button to enter configuration mode.

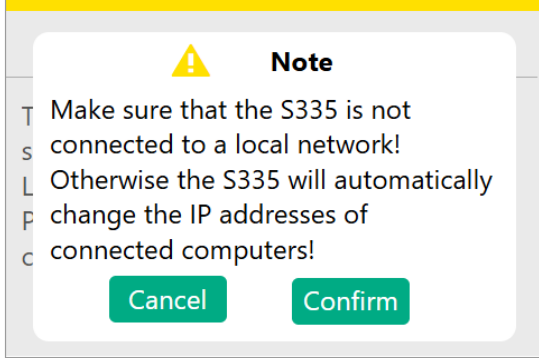
1. Press and hold the button  to enter the configuration mode.



A note reminds you to disconnect the S335 to any LAN.

2. Press the button  to select **Confirm** to enter the configuration mode or select **Cancel** to stay in the operation mode.
3. To confirm your selection, press the button  again.



Configuration Mode Enabled!

Connect your PC to the S335 with an Ethernet cable. Enter the IP add. 192.168.8.8 in the browser to set up the connection.
Do not connect to a local network while in Configuration Mode!
To exit, press and hold the key.



Successful switching to the configuration mode.

4. Input the IP address 192.168.8.8 in the URL of the browser in your PC.



Attention!

In the configuration mode, the S335 works as a DHCP server, which can assign new IP addresses to devices in the local area network (LAN). Please ensure that the S335 is not connected to a LAN before switching it to the configuration mode. The configuration mode is intended solely for direct PC connection for the configuration via the S4C-Web.

Switch from configuration mode to the operation mode:

In the configuration mode, press and hold the  button to enter the operation mode.

10.1.2 Connect through a LAN

1. Power on the S335.
2. Make sure the S335 is in the operation mode.
3. Connect the S335 and PC to the same local network.
4. Log on to the S4C-Web by entering the S335 IP address in the browser.

Note: The IP address can be got on page 5 of the S335 screen.

By default, the S335 is in operation mode. The following describes how to identify the S335 is in the operation mode or is in the configuration mode.

10:30 P 6/6

Configuration

This allows the S335 to act as a DHCP server and connect directly to a PC via LAN.

Press and hold the button to enter configuration mode.

In the operation mode, the S335 screen on page 6 displays the information shown on the left.

10:30 P 6/6

Configuration Mode Enabled!

Connect your PC to the S335 with an Ethernet cable. Enter the IP add. 192.168.8.8 in the browser to set up the connection.
Do not connect to a local network while in Configuration Mode!
To exit, press and hold the key.

Exit

In the configuration mode, the S335 screen on page 6 displays the information shown on the left.

10.2 Username and Role

The S335 supports only 2 user roles to log on the S4C-Web: **admin** and **user**. The **admin** can view and modify settings, and the **user** can only view data.

Both usernames are fixed and cannot be changed. Both username and initial password list below. Only the **admin** can change its password.

admin	Username	admin (cannot be changed)
	Initial password	SUTOadmin@2005 (can be changed)
user	Username	user (cannot be changed)
	Initial password	SUTOuser@2005 (cannot be changed)

Note:

- If you, as an **admin**, changed the initial password and cannot remember it, please contact the SUTO iTEC service team and provide the device serial number.
- The following setting operations from section 10.3 to section 10.6 can only be done by the **admin**.

10.3 Change Password and Language

After you log on to the S4C-Web, you can change the interface language and password.

10.3.1 Change Password

Only the **admin** can change its password.

Note: Both the **admin** and **user** cannot modify the username.

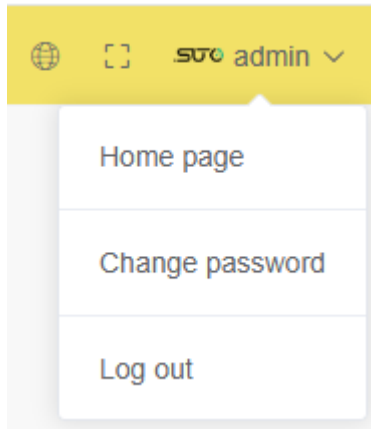

1. Click **admin** on the upper-right page.
 - If logging on as an **admin**, you can see **Change Password** and **Logout**.
 - If logging on as a **user**, you can only see **Logout**.

Change password ×

Old password

New password

Confirm password

2. Click **Change Password**.
3. On the pops up window, enter the old and new password, then click **Confirm**.

10.3.2 Reset Password

1. If you forget the password you set, contact the SUTO iTEC service team and provide the device serial number. STUO iTEC provides a one-time password.
2. Click **Forget password?** on the login page of the S4C-Web to reset your password.

10.3.3 Change Language

You can change the S4C-Web language by clicking the  icon on the top-right bar.

Note: After the language on the S4C-Web interface is changed, the language on the S335 display is changed accordingly.

10.4 Sensor Settings

After the S335 communicates with your PC, the S4C-Web will read out data from S335. For a brand-new S335, sensor settings are all blank.

The following sections describe how to add SUTO iTEC sensors and the 3rd-party sensors, as well as assign sensor channels to specified measurement location and points.

10.4.1 Add SUTO iTEC Sensors

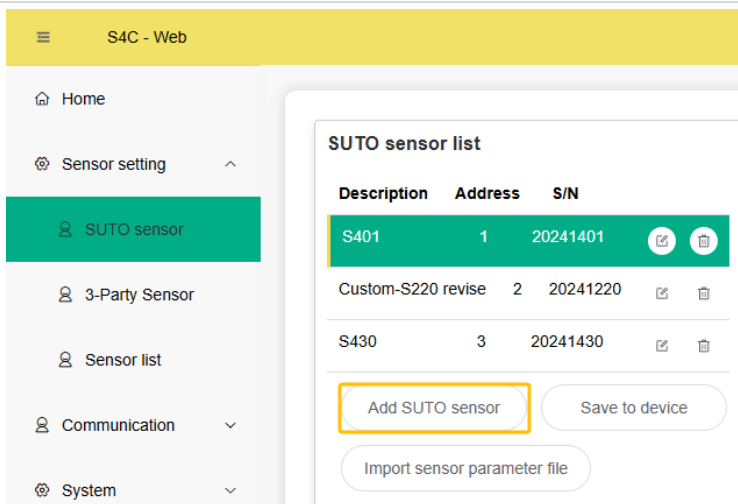

1. Click **Sensor setting > SUTO sensor > Add SUTO sensor** on the S4C-Web home page.

Add SUTO sensor

Sensor type: SUTO-S401

Description: S401

Address: 0

S/N: 00000000

Confirm Cancel

2. From the drop-down list, select the desired sensor, then the description field shows a predefined SUTO iTEC sensor name.
Note: use different descriptions for the same type of sensors.
3. Click **Add** to add the sensor.

After the SUTO iTEC sensor is added, it is displayed on the left page with green background. The right page shows the sensor’s predefined channels.

The **Show** checkbox: As the S335 screen does not display live data, you need to select **Show** for a channel, the channel is then displayed on the higher-level system and on the sensor list of the S4C-Web interface.

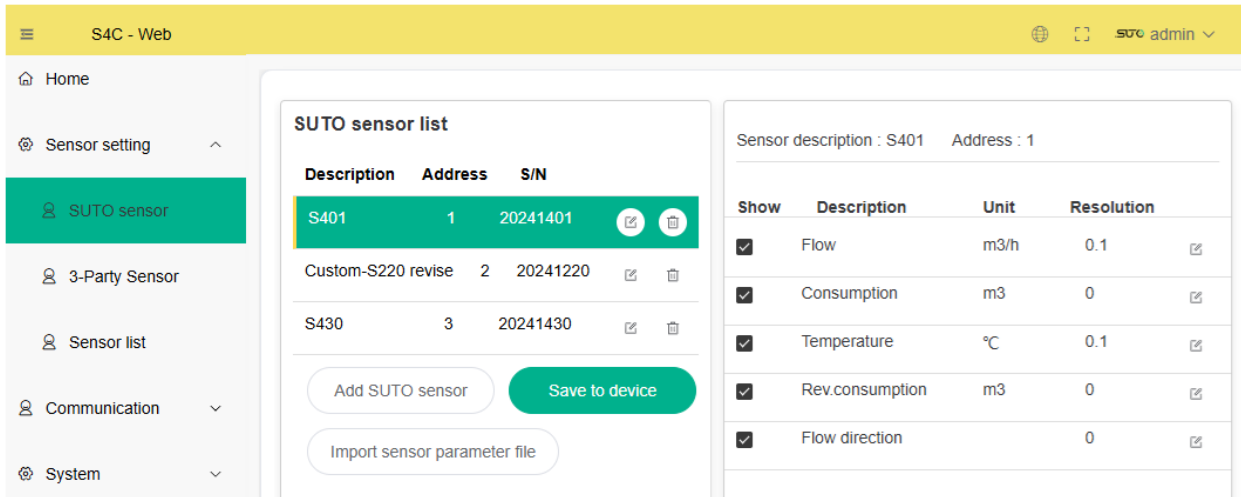

SUTO sensor list

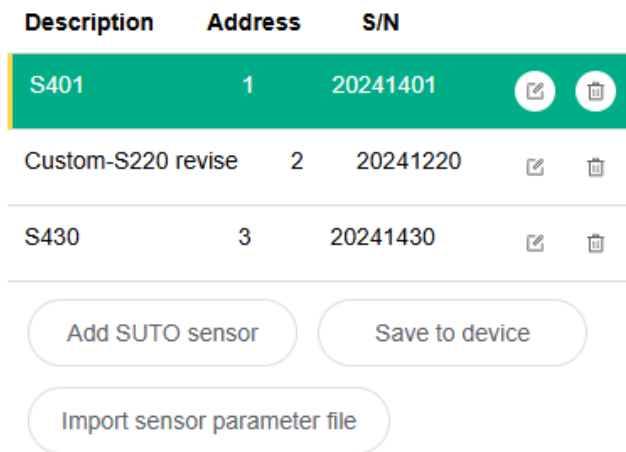

- Click the edit icon to modify the sensor description and Modbus address.
- Click the delete icon to delete the sensor.

Add another SUTO iTEC sensor. The newly created sensor is displayed with green background.

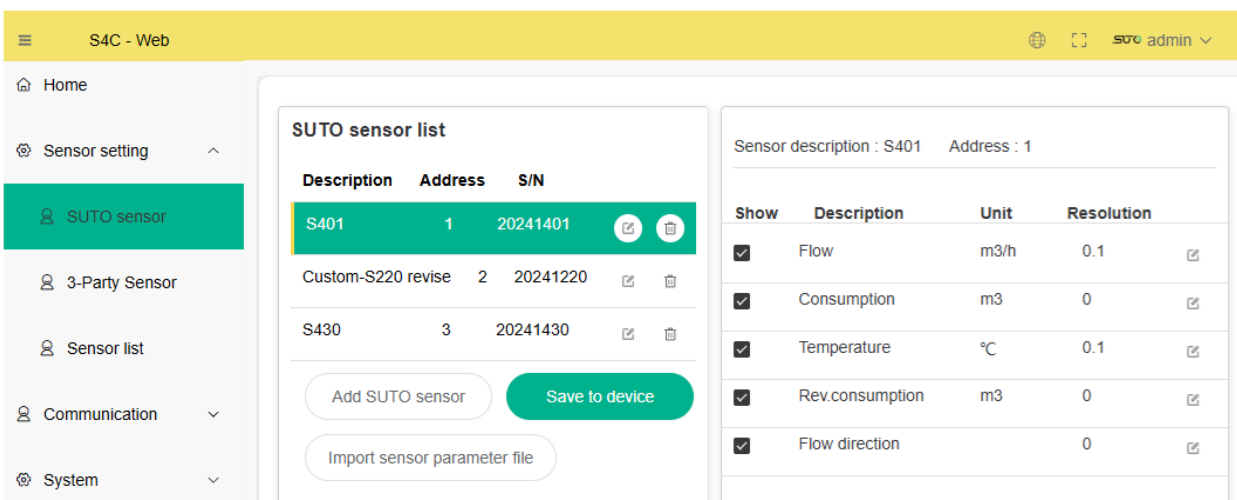

Click **Save to Device** to download the current settings to the S335. This takes a few seconds.

If you want to exit the current page without saving the settings and switch to another page during the operation, the S4C-Web will display a pop-up window as shown below.

Warning !

You have changed settings that are not saved to the device. If you leave this page, you will lose these changes.
Do you want to leave this page?
If Yes, we will not save his changes.
If No, you will be taken back to the page where you made your changes.

No Yes



Click **Yes** to switch to another page without saving the current settings. Click **No** to go back to the current page.

10.4.2 Add 3rd Party Sensors

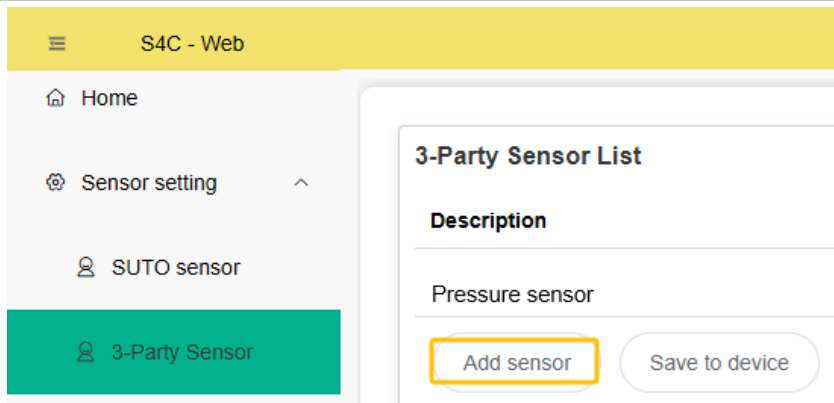

1. Click **Sensor setting > 3-Party Sensor > Add sensor.**

Add sensor

Description: Pressure sensor
Address: 12
S/N: 12268826

2. Input description and Modbus address.

Confirm Cancel

Edit channel
✕

Channel description

Address

Resolution ▼

Unit

Input value type ▼

Output value type ▼

MB function code

Error value

Cancel
Confirm

3. Click **Confirm** and enter the **Edit channel** page.

After the sensor and its channel are created, the sensor is shown in the list, and the channel is also displayed on the right.

The screenshot shows the S4C-Web interface. On the left is a navigation menu with 'Sensor setting' selected. The main area is titled '3-Party Sensor List' and contains a table with one sensor entry: 'Sensor' at address '12' with S/N '00000000'. Below the table are 'Add sensor' and 'Save to device' buttons. To the right, a panel shows 'Sensor description : Sensor Address: 12' and a table with one channel entry: 'Channel1' at address '12' with unit 'm/s'. Below this table is an 'Add channel' button.

Sensor description : Sensor Address: 12

Index	Description	Address	Unit
1	Channel1	12	m/s
2	Channel2	2	m/s

Add channel

- Click to edit the sensor description and address. Click to delete the sensor.
- Click **Add channel** to add an additional channel. Click to delete the specified channel.

4. Click **Save to Device** to download current settings to the S335. It takes a few seconds for the S335 to load settings.

10.4.3 Assign Channels to Measurement Location and Point

After sensors are all added, the right side of the page shows all the sensor channels one by one.

If there is no location or point created, the drop-down lists are all blank.

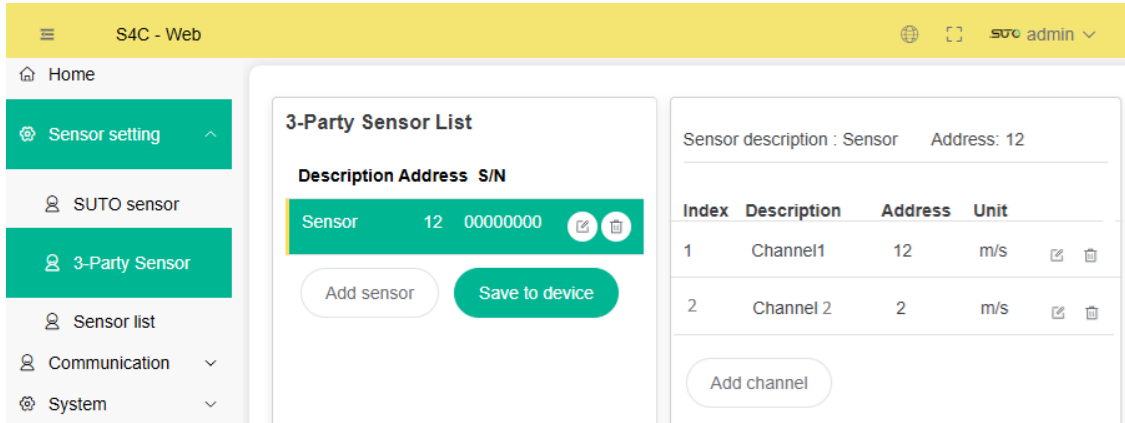

Follow steps below to assign channels to desired measurement location and measurement point.

Add measurement location ×

Description

Confirm
Cancel

1. Click **Sensor list** > **Add measurement location** to enter the page.

Sensor list

Measurement location	Measurement point
Location 1	✎ 🗑

Add measurement location

Save to device

2. Enter the location name and confirm to add the location.

Click ✎ to edit the measurement location.
 Click 🗑 to delete the location.

Create measurement point
×

Description

Confirm
Cancel

3. Click a specific location, and then click **Add measurement point** to add a measurement point.

4. After all measurement locations and points are created, assign each channel to a specific location and point from the drop-down list.

Sensor list

Measurement location	Measurement point		
Location 1	P1	<input checked="" type="checkbox"/>	<input type="checkbox"/>
Location 2	Location2 - P1	<input checked="" type="checkbox"/>	<input checked="" type="checkbox"/>

Add measurement location

Add measurement point

Save to device

Assign locations

Sensor	Channel	Measurement location	Measurement point
Sensor	Channel1	Location 1 <input type="text"/>	P1 <input type="text"/>
Sensor	Channel2	Location 2 <input type="text"/>	... <input type="text"/>

10.5 Communication Settings

The **Communication** menu provides the following functions:

- 4G settings
- Ethernet settings
- Modbus/RTU settings
- S4M SaaS settings
- Export holding register

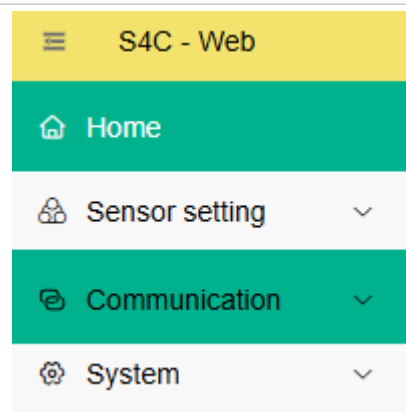

10.5.1 4G Settings

1. Click **Communication > 4G setting** to enter the 4G setting interface.

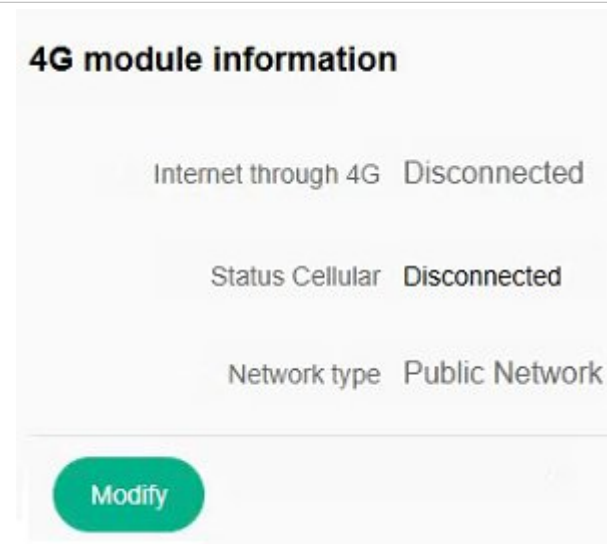

Two statuses on the 4G modem: Internet status and cellular status.

- The Internet status indicates whether the S335 is successfully connected to the Internet.
- The cellular status indicates whether the S335 is connected to the mobile network.

2. Click **Modify** to modify the network type, authentication mode, APN, username, and password.

Network types	<ul style="list-style-type: none">• Public network: For most cases• Private network: Only for some special cases
Authentication mode	<ul style="list-style-type: none">• None• PAP• CHAP• PAP or CHAP

10.5.2 Ethernet Settings

Click **Communication** > **Ethernet information** to enter the interface.

The Ethernet settings can be modified in both operation mode and configuration mode.

Settings in the operation mode

Ethernet information

Internet through Ethernet Connected

Ethernet status Connected

IP address 192.168.0.91

Subnet mask 255.255.255.0

Default gateway 192.168.0.1

Mac address 74:a5:8c:ef:28:f5

DHCP Enabled

Modify

On the **Ethernet information** page, click **Modify**, then you can modify relevant IP settings.

Info: In default mode, the S335 acts as a client which can fetch IP address from a router; While in configuration mode, the S335 acts as a router which can assign IP address to the connected PC automatically.

Settings in the configuration mode

Ethernet information

IP address 192.168.8.8
Mode Configuration Mode

Modify

The IP address on the page is for configuration mode. It is fixed, and cannot be modified.

Info: In default mode, the S335 acts as a client which can fetch IP address from a router; While in configuration mode, the S335 acts as a router which can assign IP address to the connected PC automatically.

Click **Modify** to modify IP settings for the operation mode.

Ethernet information

IP address 192.168.0.103 ✓
Subnet mask 255.255.255.0 ✓
Default gateway 192.168.0.1| ✓
DHCP

Cancel Confirm

On this page, input IP settings for the operation mode.

Info: In default mode, the S335 acts as a client which can fetch IP address from a router; While in configuration mode, the S335 acts as a router which can assign IP address to the connected PC automatically.

Notes:

- The IP configured here is for the operation mode. This IP takes effect only when the S335 goes to the configuration mode.
- When DHCP is enabled, IP settings of the S335 are assigned automatically and cannot be configured manually.

10.5.3 Modbus Setting

The S335 features two Modbus/RTU ports, acting as the Modbus/RTU master and slave separately.

1. Click **Communication > Modbus setting (Master)** to enter the interface.
2. Click Modify to set related parameters.

Modbus setting (Master)

Modbus connection information

Protocol RTU

Baud rate 19200

Response timeout(s) 10

[Modify](#)

Info: This is the input for the sensor via Modbus/RTU (RS485)

The Modbus/RTU master port is the input for the sensor via Modbus/RTU (RS-485).

RS485 setting (Slave)

Filed-Bus RS485 Connection Information

Protocol RTU

Modbus address 1

Baud rate 115200

[Modify](#)

Info: This is the connection to a higher level system / software (e.g. Building Management System) via Modbus/RTU (RS485)
Please find the Slave Holding Register under Holding Register

The Modbus/RTU slave port is to connect to a higher-level system / software via Modbus/RTU (RS-485). You can find the slave holding register under **Holding Register**.

10.5.4 S4M SaaS Settings

The S4M SaaS (Software as a Service) is a software hosted on the cloud and accessed via an Internet connection using a web browser. The S4M SaaS solution is designed to facilitate the monitoring and optimization of compressed air systems.

Before establishing a connection between the S4C-Web and the S4M SaaS, it is necessary to complete the following configurations on the S4C-Web.

1. Click **Communication > SaaS connection information > Modify**.

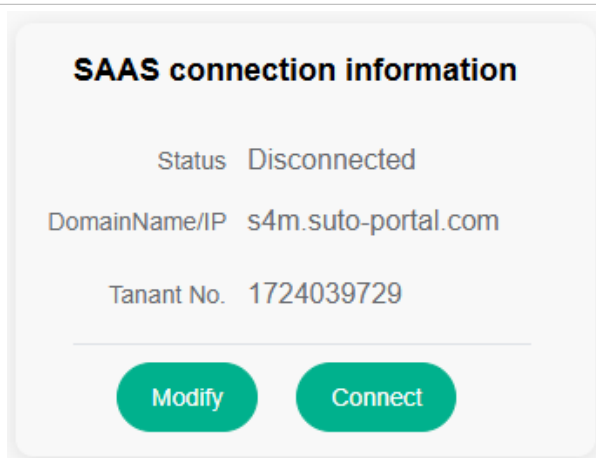

2. Enter the domain name or IP address of the S4M SaaS server.
3. Enter the Tenant Number created by the S4M SaaS.

Note: S4M SaaS is a paid service, please contact SUTO service team if necessary.

Note: If the S335 is connected to the S4M SAAS with both the 4G modem and an Ethernet cable, the 4G modem connection is on priority. That is, the S335 communicates with the S4M SaaS only through the 4G modem.

10.5.5 Export Holding Register

To export the register table, navigate to the **Holding register table** menu and click **Export PDF**.

10.6 System

The **System** menu provides the following functions:

- View system information
- Change Date/Time Setting
- Update the S335 firmware
- Import/Export configuration File

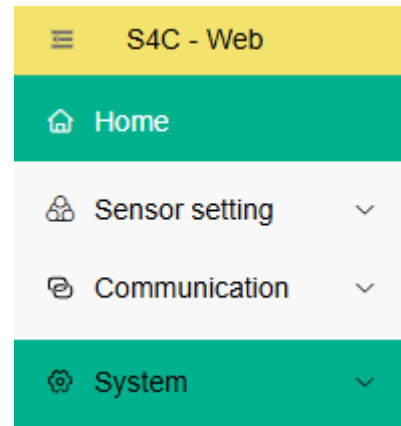

10.6.1 System Information

It shows the S335 information, including P/N, S/N, firmware, and hardware version.

10.6.2 Date/Time Setting

It is used to set the S335 date/time. You can set time for the S335 either from the Internet or by manually.

10.6.3 Firmware Update

The S335 firmware update can be done via the S4C-Web.

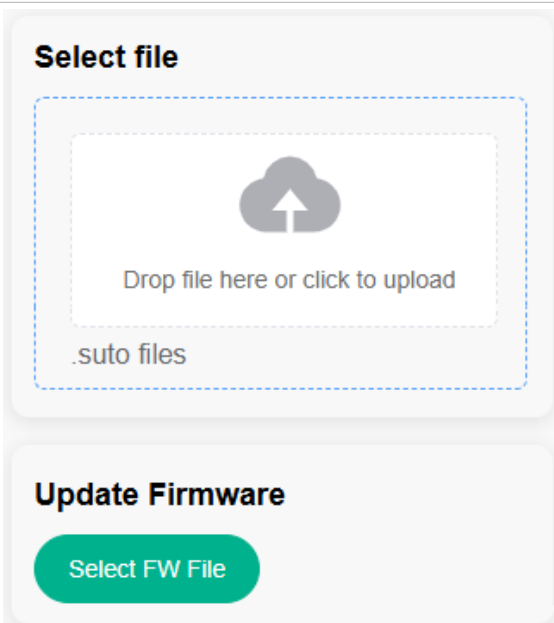

1. Click **System** > **Firmware update**.
2. Drag the S335 firmware file into the upload area or click **Select FW File** to select the firmware file.
3. Click **Firmware Update** to start the update process.

Notes:

- Select and click on the file name with *.suto* suffix to initiate the firmware update.
- DO NOT upload firmware files other than S335.

10.6.4 Import/Export Configuration File

If the configurations among several S335 are nearly identical, you can configure the first S335 and export its configurations to a file. A configuration file contains sensor settings, communication settings, and time zone setting.

Then establish the communication between S4C-Web and another S335, import the configuration file, and modify it. This approach can result in time and cost savings.

Click **System > Import/Export configure** to import/export the configuration file.

Import/Export configure

Info:
Here you can save the configuration file of the S335 to your local drive. Or use this function to import an existing configuration file to this S335.

Export configure

Import configure to device

11 Maintenance

To clean the S335 and its accessories, it is recommended to use moist cloth only.



ATTENTION!

Do not use isopropyl alcohol to clean the S335!

12 Disposal or Waste



Electronic devices are recyclable material and do not belong in the household waste.

The device, the accessories and its packing must be disposed of according to your local statutory requirements. The dispose can also be carried by the manufacturer of the product. Please contact the manufacturer for details.

13 Appendix – Modbus Interface

The default settings of the Modbus interface are as follows:

Mode	: TCP
DHCP	: Yes
MAC	: Set ex-factory
IP address	: Dynamic or Static
Subnet	: Dynamic or Static
Gateway	: Dynamic or Static
Timeout	: ≥ 200 ms
Mode	: RTU
Baud rate	: 19200
Device address	: 1
Framing / parity / stop bit	: 8, N, 1
Response time	: 1 second
Response delay	: 0 ms
Inter-frame spacing	: 7 char

Response message that the device returns to the master:

- Function code: 03

The information on the byte order is shown in the table below:

Byte Order	Sequence				Data Type
	1st	2nd	3rd	4th	
1-0-3-2	Byte 1 (MMMMMMMM*)	Byte 0 (MMMMMMMM *)	Byte 3 (SEEEEEEE)	Byte 2 (EMMMMMMM *)	FLOAT
1-0-3-2	Byte 1	Byte 0 LSB	Byte 3 MSB	Byte 2	UINT32 INT32
1-0	Byte 1 MSB	Byte 0 LSB	---	---	UINT16 INT16
1-0	Byte 1 XXX *	Byte 0 DATA	---	---	UINT8 INT8

* S: Sign, E: Exponent, M: Mantissa, XXX: no value

Explanations of MSB and LSB

MSB MSB refers to Most Significant Byte first, which follows the Big-Endian byte order.

For example, if the main system follows the MSB first order:

When the 4-byte floating number, in the order of Byte1-Byte0-Byte3-Byte2, is received from the slave (sensor), the master must change the byte order to Byte3-Byte2-Byte1-Byte0 for the correct display of the value.

LSB LSB refers to Least Significant Byte first, which follows the Little-Endian byte order.

For example, if the main system follows the LSB first order:

When the 4-byte floating number, in the order of Byte1-Byte0-Byte3-Byte2, is received from the slave (sensor), the master must change the byte order to Byte0-Byte1-Byte2-Byte3 for the correct display of the value.

SUTO ITEC GmbH

Grißheimer Weg 21
D-79423 Heitersheim
Germany

Tel: +49 (0) 7634 50488-00

Email: sales@suto-itec.com

Website: www.suto-itec.com

SUTO ITEC (ASIA) Co., Ltd.

Room 10, 6/F, Block B, Cambridge Plaza
188 San Wan Road, Sheung Shui, N.T.
Hong Kong

Tel: +852 2328 9782

Email: sales.asia@suto-itec.com

Website: www.suto-itec.com

SUTO ITEC Inc.

5460 33rd St SE
Grand Rapids, MI 49512
USA

Tel: +1 (616) 800-7886

Email: sales.us@suto-itec.com

Website: www.suto-itec.com
