



Be smart. Measure it.

English

# Instruction and Operation Manual

## S532

### Acoustic Imaging Detector



Dear Customer,

Thank you for choosing our product.

The operating instructions must be read in full and carefully observed before you start up the device. The manufacturer cannot be held liable for any damage which occurs because of non-observance or non-compliance with this manual.

Should the device be tampered with in any manner other than a procedure which is described and specified in the manual, the warranty is void and the manufacturer is exempt from liability.

The device is designed exclusively for the described application.

SUTO offers no guarantee of the suitability for any other purpose. SUTO is also not liable for consequential damage resulting from the delivery, capability or use of this device.

Revision: 2025-1-1



Last modifications: December, 2025

## Table of Contents

1 Overview .....	8
1.1 Device Description.....	8
1.2 Main Function.....	8
1.3 Technical Data.....	9
1.4 Scope of Delivery .....	10
1.5 Appearance.....	12
2 Procedure of Detecting Leaks.....	15
3 Preparation.....	16
3.1 Mount Hand Strap.....	16
3.2 Operation Method.....	17
3.3 Charge Device.....	18
3.3.1 Charge Device via Cable Interface.....	18
3.3.2 Charge Device via Charging Base.....	19
3.4 Power On/Off.....	20
3.4.1 Set Auto Power-off Countdown.....	21
3.5 Sleep and Wake.....	21
3.6 Live Interface and Menu.....	21
3.6.1 Live View Interface.....	21
3.6.2 Menu.....	24
4 Acoustic Wave Detection.....	25
4.1 Set Detection Mode.....	25
4.1.1 Partial Discharge Types and Levels.....	25
4.1.2 Gas Leakage Estimation.....	27
4.2 Select Frequency Range.....	28
4.2.1 Switch among Pre-defined Target Frequency Ranges.....	29
4.2.2 Set Target Frequency Range Manually .....	29
4.3 Set Acoustic Palettes.....	30
4.3.1 Set Palette Color.....	30
4.3.2 Set Palette Opacity.....	30
4.3.3 Set Intensity Range for Palettes.....	31
4.4 Set Sound Source Distance.....	32
4.5 Set Detection Sensitivity.....	32
4.6 More Tools.....	32
4.6.1 Mark and Display Peak Intensity.....	32
4.6.2 Regional Detection Frame.....	33
4.6.3 Show Multiple Sound Sources.....	34

---

5 Display Settings.....	34
5.1 Set Screen Brightness.....	34
5.2 Adjust Digital Zoom.....	35
5.3 Display OSD Info.....	35
5.4 Set Grayscale of Visual Image.....	35
6 Picture and Video.....	36
6.1 Capture Picture.....	36
6.2 Record Video.....	37
6.3 View and Manage Local Files.....	37
6.3.1 Manage Albums.....	38
6.3.2 Manage Files.....	39
6.3.3 Edit Files.....	40
6.4 Export Files.....	41
7 Maintenance.....	42
7.1 View Device Information.....	42
7.2 Set Language.....	42
7.3 Set Time and Date.....	42
7.4 Upgrade Device.....	42
7.5 Restore Device.....	43

## **Safety instructions**

These instructions are intended to ensure that users can use the product correctly to avoid danger or property loss.

### **Laws and Regulations**

- Use of the product must be in strict compliance with the local electrical safety regulations.

### **Transportation**

- Keep the device in original or similar packaging while transporting it.
- Keep all wrappers after unpacking them for future use. In case any failure occurred, you need to return the device to the factory with the original wrapper. Transportation without the original wrapper may result in damage to the device and the company shall not take any responsibilities.
- DO NOT drop the product or subject it to physical shock. Keep the device away from magnetic interference.

### **Power Supply**

- Please purchase the charger by yourself. Input voltage should meet the Limited Power Source (5 VDC, 2 A) according to the IEC61010-1 standard. Please refer to technical specifications for detailed information.
- Make sure the plug is properly connected to the power socket.
- DO NOT connect multiple devices to one power adapter, to avoid over-heating or fire hazards caused by overload.

### **Battery**

- Improper use or replacement of the battery may result in explosion hazard. Replace with the same or equivalent type only. Dispose of used batteries in conformance with the instructions provided by the battery manufacturer.
- The built-in battery cannot be dismantled. Please contact the manufacturer for repair if necessary.
- For long-term storage of the battery, make sure it is fully charged every half year to ensure the battery quality. Otherwise, damage may occur.

- DO NOT charge other battery types with the supplied charger. Confirm there is no flammable material within 2 m of the charger during charging.
- DO NOT place the battery near the heating or fire source. Avoid direct sunlight.
- DO NOT swallow the battery to avoid chemical burns.
- DO NOT place the battery in the reach of children.

### **Maintenance**

- If the product does not work properly, please contact your dealer or the nearest service center. We shall not assume any responsibility for problems caused by unauthorized repair or maintenance.
- Wipe the device gently with a clean cloth and a small quantity of ethanol, if necessary.
- If the equipment is used in a manner not specified by the manufacturer, the protection provided by the device may be impaired.



### **Application Environment**

- Make sure the running environment meets the requirement of the device. The operating temperature shall be -20°C to 50°C (-4°F to 122°F), and the operating humidity shall be 90% or less.
- DO NOT expose the device to high electromagnetic radiation or dusty environments.
- Do not use the product in explosive and hazardous environments.
- DO NOT aim the lens at the sun or any other bright light.

## Emergency

If smoke, odor, or noise arises from the device, immediately turn off the power, unplug the power cable, and contact the service center.

## Symbol Conventions

Symbol	Description
 <b>Danger</b>	Indicates a hazardous situation which, if not avoided, will or could result in death or serious injury.
 <b>Caution</b>	Indicates a potentially hazardous situation which, if not avoided, could result in equipment damage, data loss, performance degradation, or unexpected results.
<b>Note</b>	Provides additional information to emphasize or supplement important points of the main text.

## Registered trademarks

SUTO®	Registered trademark of SUTO iTEC
MODBUS®	Registered trademark of the Modbus Organization, Hopkinton, USA
Android™, Google Play	Trademarks of Google LLC

## 1 Overview

### 1.1 Device Description

The Acoustic Imaging Detector S532 is a professional product for sound source localization. With its 64 low-noise MEMS microphones and adjustable bandwidth range, it provides an easy and effective way to locate pressurized air leaks or partial discharge in industrial environments. By using a large 4.3" LCD touch screen, the results overlaying on a visual image allows you to quickly find the source of the problems. Adopting this lightweight and easy-to-use tool, you can discover the potential safety risks, minimize troubleshooting, and save extra costs of equipment failures and downtime.

### 1.2 Main Function

#### **Acoustic Imaging**

The device detects the real-time sound intensity of the sources, and locates the sources in the scene.

#### **Partial Discharge Detection (PD)**

The device detects partial discharge activities, estimates their types based on sound frequency, and displays the real-time estimation in live view for your reference.

#### **Gas Leakage Detection (LD)**

The device detects and estimates real-time gas leak rate, leak cost, and leak level for reference.



#### **Palette**

The device supports multiple palettes to display the detected sound sources and their intensities.

#### **Record Videos & Capture Snapshots**

The device supports recording videos, capturing snapshots, and managing albums.

### 1.3 Technical Data

 		
<b>Acoustic</b>		
Microphones	64 low-noise MEMS microphones	
Bandwidth	0 kHz ... 96 kHz	
Measuring distance	0.3 m ... 100 m	
Acoustic image palette	White Black, Black White, Rainbow, Fusion, Ironbow, Red Black, Rain, Blue Red	
Dynamic range	Low Limit: <-15 dB High Limit: >120 dB	
Leak rate	>0.008 l/min @ 6 bar from 0.5 m >0.013 l/min @ 5 bar from 1 m	
Discharge detection	Automatic detection 50 / 60 Hz	
Discharge type	Corona Discharge, Particle Discharge, Floating Discharge, Surface Discharge	
<b>Data Storage and Communication</b>		
Storage media	Removable 64 GB SD Card	
Image storage capacity	20,000 images	
Annotations	Voice note: max. 60 seconds Text note: max. 255characters	
Video storage capacity	60 hours	
Video file format	MP4	
<b>General</b>		
Display	800 × 480 resolution, 4.3" LCD touch screen	
Digital zoom	1.0x to 16.0x continuous	
USB interface	USB Type-C	
HDMI interface	HDMI-D	
Battery	Operating time	Approx. 3.5 hours
	Type	Dis-mountable and rechargeable Li-ion Battery
	Parameter	3.6 VDC, 6230 mAh (22.43 Wh)
	Charging time	5 hours to full charge

Protection level	IP54
Approvals	CE, UKCA, RCM
Power supply	5V DC/2A (Charging via USB)
Working temperature	-20°C ... 50°C
Storage temperature	-20°C ... 60°C
Relative humidity	<90% non-condensing
Weight	Approx. 940 g
Dimension	292.2 × 127 × 110.7 mm

## 1.4 Scope of Delivery

Qty	Description	Item No.
1	S532 Acoustic Imaging Detector Set	P601 0105
1	Battery packs, exchangeable, set of 3 pcs., 3.6 VDC, 6230 mAh (22.43 Wh)	A654 0001
1	MIC protective case, protect the MEMS microphones	A654 0002
1	Charger, input 100...240V AC, output 12 VDC, 2A	A654 0003
1	Charging base, input 12 VDC, 2A	A654 0004
1	Transport case S532	A654 0005
1	Leak tags to mark found leaks, 100 pieces	A554 0122
1	LMS (Leak Management Software), local installation, 1 license (bound to local PC), no subscription, one-time payment	M599 7045
1	Quick Start Guide	N/A
Optional accessory		
1	Ultrasonic transmitter	A554 0133

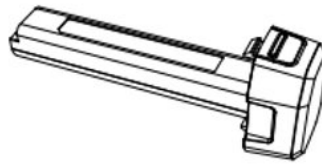
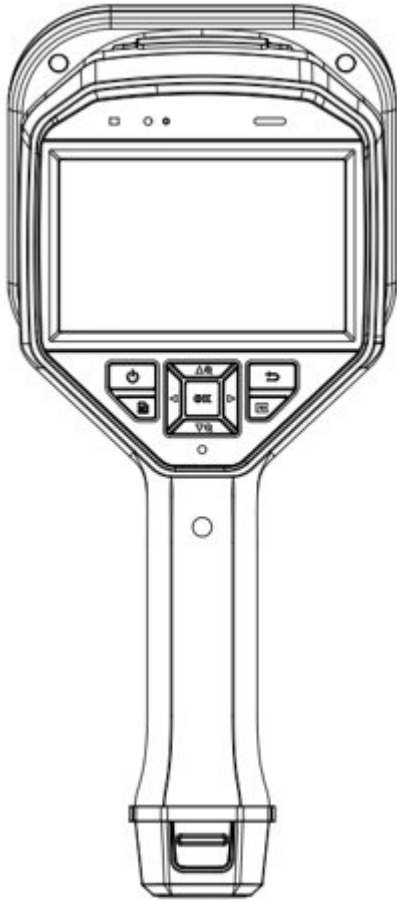

Battery (x2)

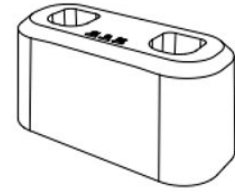

Charging base (x1)

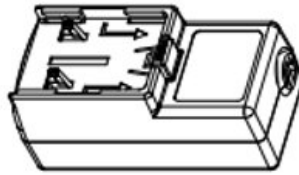

Charger (x 1)

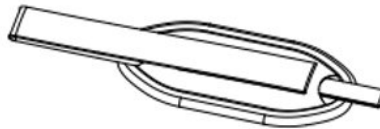
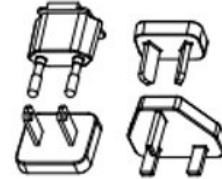

Hand strap (x1)



USB cable (x1)



HDMI cable (x1)



SD card (x1)

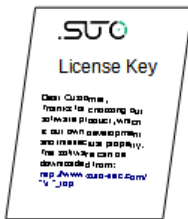

LMS license key (x1)

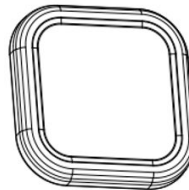

MIC protective case(x1)

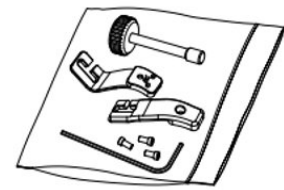

Accessories bag (x1)



Leak tag (x100)



Quick Start Guide (x1)

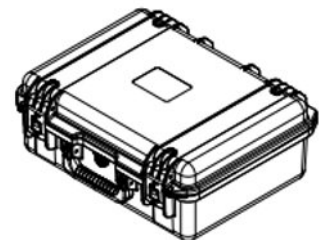

Transport case (x1)

### 1.5 Appearance

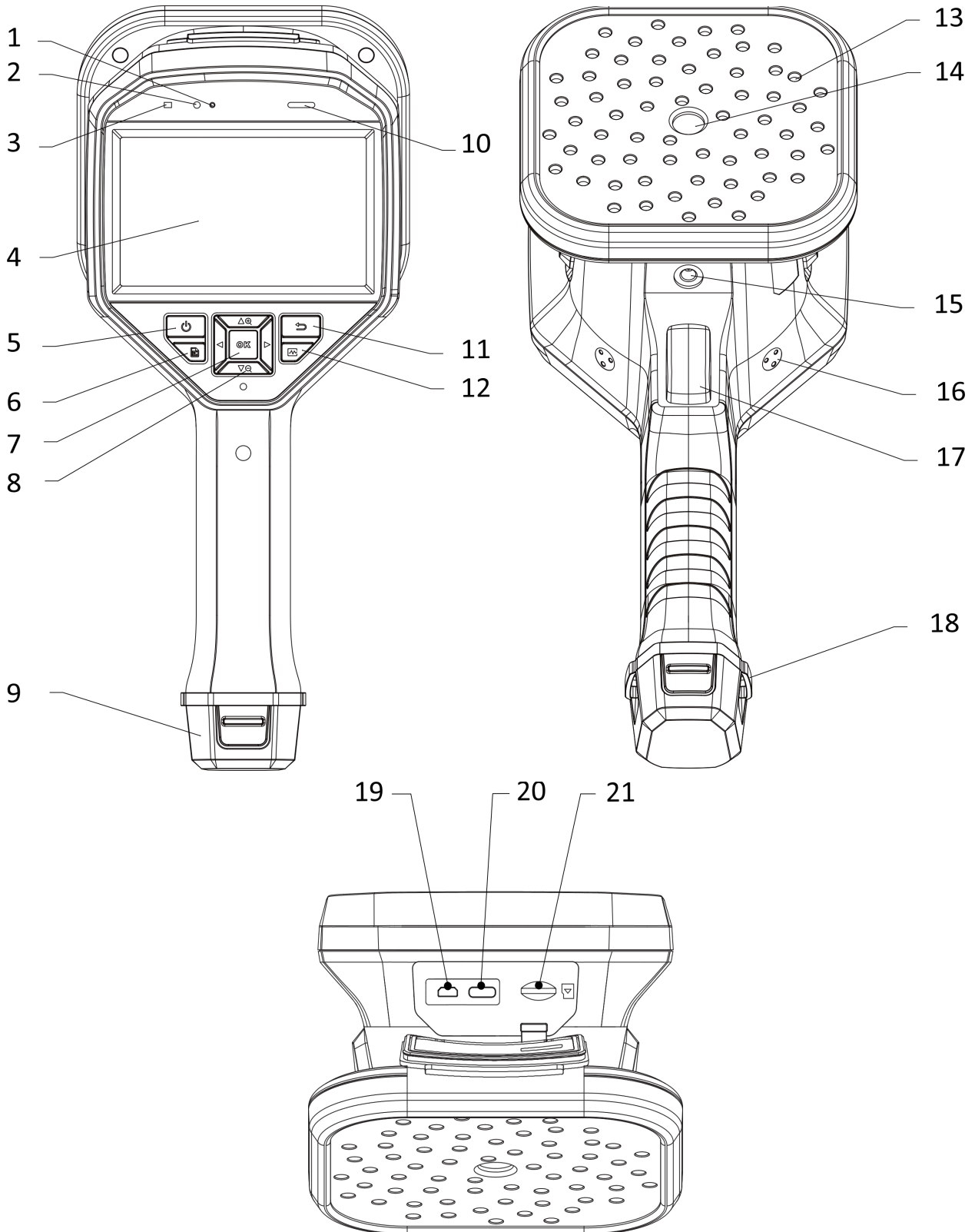





Figure 1-1 Appearance: 64-Microphone Array

## Interface Description

No.	Component	Function
1	Light Sensor	Senses the ambient brightness.
2	Microphone	Records voice remarks.
3	Power Indicator	Solid red: Charge normally. Solid green: Fully charged.
4	LCD Touch Screen	Allows live view and touch-screen operation.
5	Power Button	Hold  to power on/off.
6	File Button	Press  to access the albums.
7	Confirm Button	Non-Menu Mode: Press <b>OK</b> to enter menu. Menu Mode: Press <b>OK</b> to confirm.
8	Navigation Button	Non-Menu Mode: <ul style="list-style-type: none"> <li>Press <math>\Delta\oplus</math> or <math>\nabla\ominus</math> to zoom in or zoom out by 0.1x continuously.</li> <li>Hold <math>\Delta\oplus</math> or <math>\nabla\ominus</math> to zoom in or zoom out by 1x continuously.</li> </ul> Menu Mode: Press $\Delta\oplus$ , $\nabla\ominus$ , $\triangleleft$ and $\triangleright$ to select parameters.
9	Battery Compartment	For holding the battery.
10	Loudspeaker	Plays voice remarks.
11	Back Button	Press  to save the parameters and return to previous menu.
12	Frequency Button	Press to select the frequency range frame edges and configure the frequency parameters.
13	Microphone Array	Detects sound in the scene.
14	Visual Light Lens	Views the visual images.
15	Tripod Attachment Point	Mounts the tripod.
16	Hand Strap Attachment Points	Mounts the hand strap.
17	Trigger	Non-Menu Mode: <ul style="list-style-type: none"> <li>Press: Capture snapshots.</li> </ul>

		<ul style="list-style-type: none"><li>• Hold: Record videos.</li></ul> Menu Mode: Press to return to live view interface.
18	Hand Strap Attachment Holes	Fixes the lower part of the hand strap to the device.
19	Micro HDMI Interface	Displays the image and menu interface via HDMI output.
20	Type-C Interface	Charges the device or exports files with supplied cable.
21	MicroSD Card Slot	For holding the MicroSD card.

## 2 Procedure of Detecting Leaks

Before leak detection, preparations are needed, like mounting the hand strap and charging the battery.

A leak detection is managed by the "Project". By defining a project, the leak data are recorded. Multiple projects can be created in one S532.

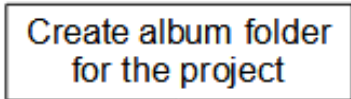
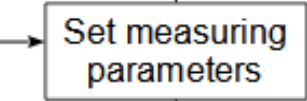
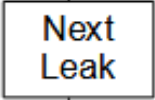
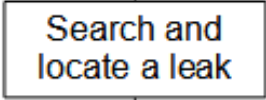
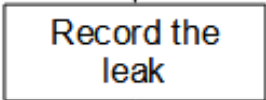
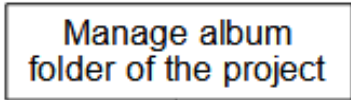
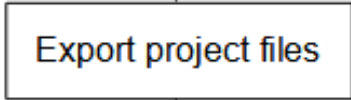
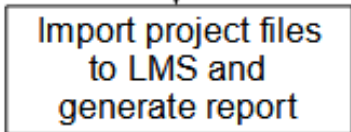
Procedure	Explanation
	Turn on the S532; click file button (📁), then click + in the upper right corner to create a new folder and name it. The folder name is the project name.
	Set the price per loss, currency unit, sensitivity, detection distance, frequency range, etc.
	Set correct distance for each leak point.
	Press the trigger button to take the picture. Each leak is assigned a leak number and a photo. The photo is named after the leak number.
	Delete photos, make voice memos and message notes in the project's album folder.
	When exporting project files, connect the S532 to the computer using the supplied USB cable, and then copy the entire project folder to the computer.
	
	

To learn how to install and use the LMS, see *LMS Installation Guide* by scanning the QR code.



## 3 Preparation

### 3.1 Mount Hand Strap

The hand straps aim at attaching to the device and stabilizing it. Please make sure to wrap your hands with the hand straps to prevent the device from accidentally falling or bumping.

The upper part of the hand strap is attached to the device by a buckle. There are two buckle attachment points on both sides of the device. The lower part of the hand strap is threaded through the holes at the base of the device.

1. Insert the upper part of the hand straps into the buckles.

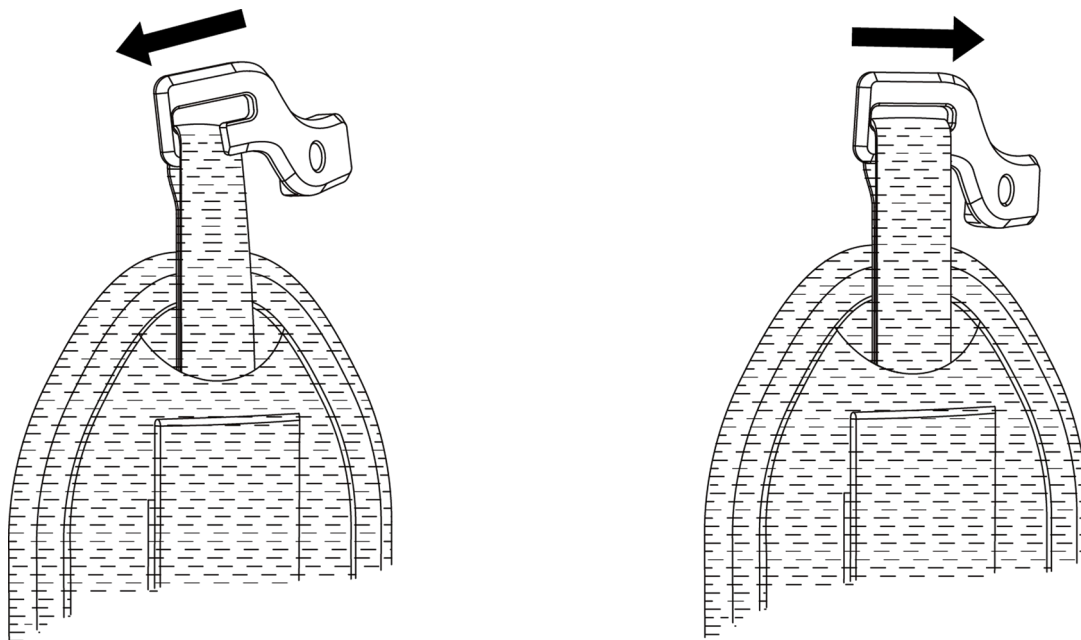

Figure 3-1 Insert Upper Part of Hand Strap

2. Fit the buckle on the device and tighten the screw with the supplied wrench.
3. Thread the lower part of the hand strap through the hole at the base of the device.
4. Secure the hand strap with the hook-and-loop fastener. Adjust the tightness according to your hands.

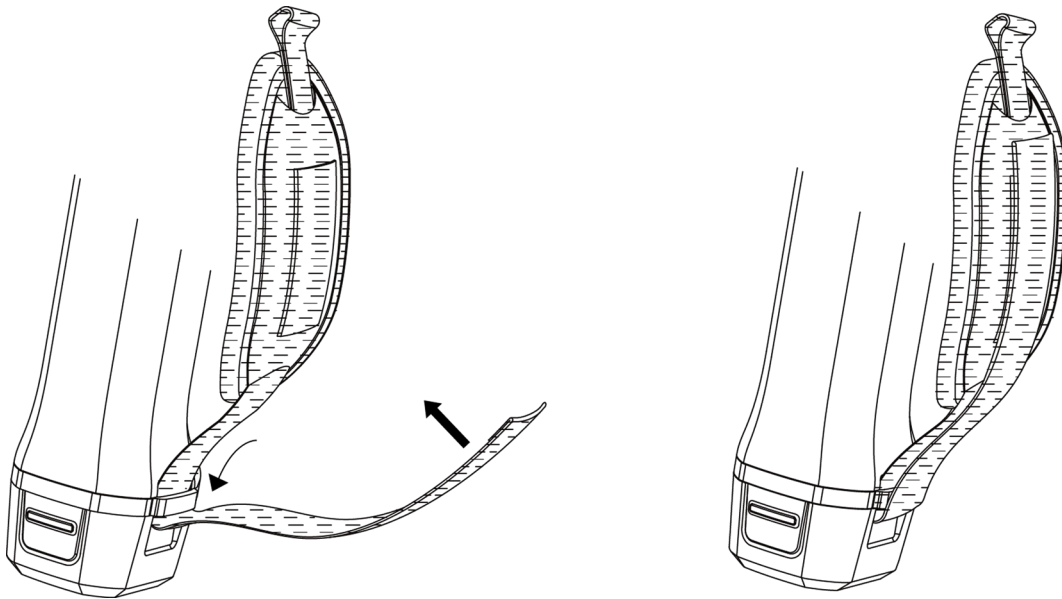

Figure 3-2 Secure Lower Part of Hand Strap

### 3.2 Operation Method

The device supports both touch-screen control and button control.

#### Touch-Screen Control

Tap on the screen to set parameters and configurations.

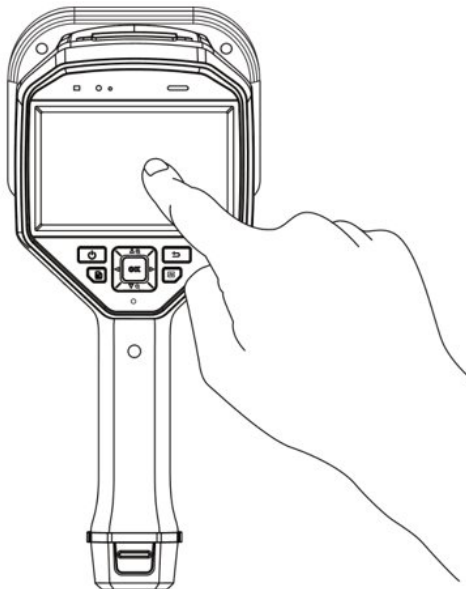

Figure 3-3 Touch-Screen Control

## Button Control

Press the navigation buttons to set parameters and configurations.

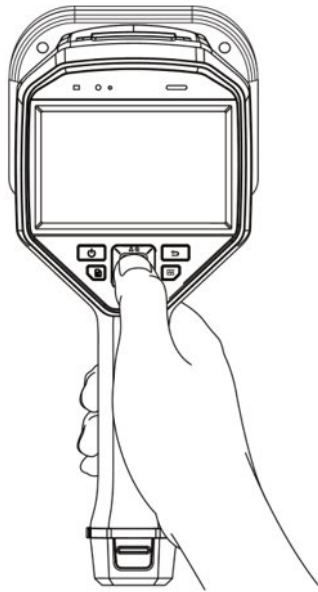

Figure 3-4 Button Control

## 3.3 Charge Device

Please fully charge the device before it is used for the first time or when it is in low battery.

### 3.3.1 Charge Device via Cable Interface

#### Before You Start

Please make sure the battery is installed before charging via cables.

#### Steps

1. Open the connector cover of the device.
2. Plug the type-C male connector of the charging cable to the device and the other type-A connector to power adapter.

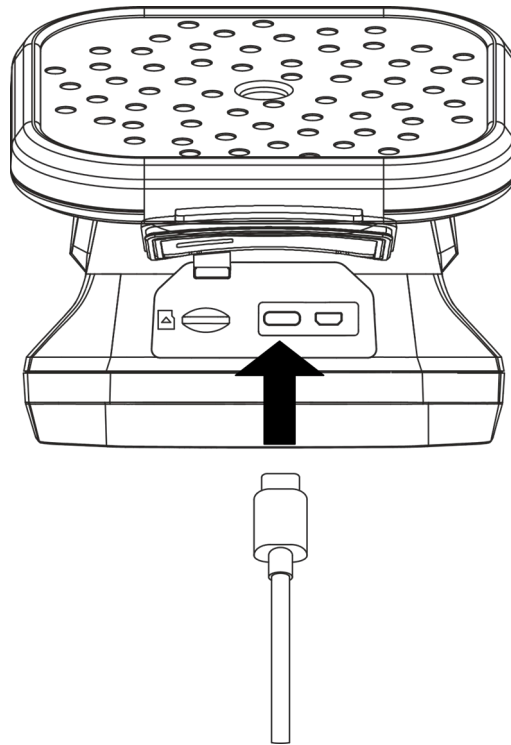

Figure 3-5 Charge via Type-C Cable

### 3.3.2 Charge Device via Charging Base

You can take out the battery and insert it into the charging base for fast charging.

#### Before You Start

Please make sure the device is powered off before removing the battery.

#### Steps

1. Hold the device, and press both battery lock catches of the device.

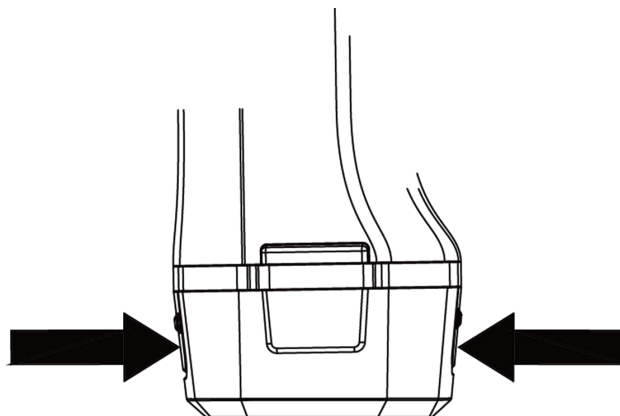

2. Hold the lock catches and draw the battery base to take out the battery.

3. Insert the battery into the charging base. You can see the charging status via the pilot lamp on the charging base.

**Note:** The red indicating light is on if the battery is charging properly, and the green indicating light is on if the battery is fully charged.

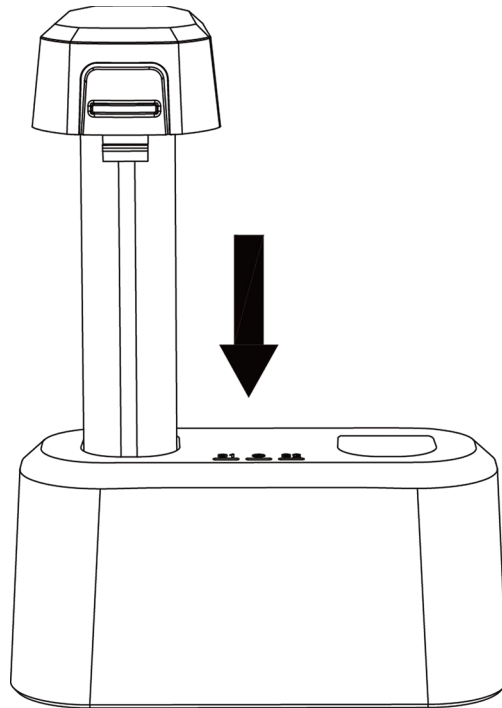

4. When the battery is fully charged, draw the battery from the charging base.
5. Insert the battery into the device and push it into the locked position.

### 3.4 Power On/Off

#### Power On

Hold  to turn on the device. You can observe the target when the live view interface is stable.

**Note:** If the battery of the device is low, please charge it in time or replace it with a fully charged standard battery, to ensure that the device functions normally.

#### Power Off

When the device is turned on, hold  to power off the device.

### 3.4.1 Set Auto Power-off Countdown

#### Steps

1. Press **OK** in the live view interface to show the menu.
2. Go to **Settings** → **Device Settings** → **Auto Off**.
3. Tap **Auto Off** or press **OK** to enable auto power-off.
4. Set the automatic shutdown time for device as required.
5. Press  to save and return to previous menu.

### 3.5 Sleep and Wake

Sleep and wake are used to save energy and increase battery time.

#### Sleep and Wake Manually

Press  to enter sleep mode and press again to wake device up.

#### Set Auto Sleep

In live view, press **OK** to call the main menu. Go to Settings → Device Settings → Auto Sleep to set

waiting time before auto sleep. When there is no button pressing or screen tapping operation on

device for more than the set waiting time, device enters sleep mode automatically.

#### Device Sleep, Scheduled Capture and Video Recording

When the device is recording a video clip or on scheduled capturing, auto sleep will not be triggered. However, pressing  will stop the video recording or scheduled capture and force the device into sleep mode.

### 3.6 Live Interface and Menu

#### 3.6.1 Live View Interface

After starting up, the device screen shows the live view interface with detected acoustic wave.

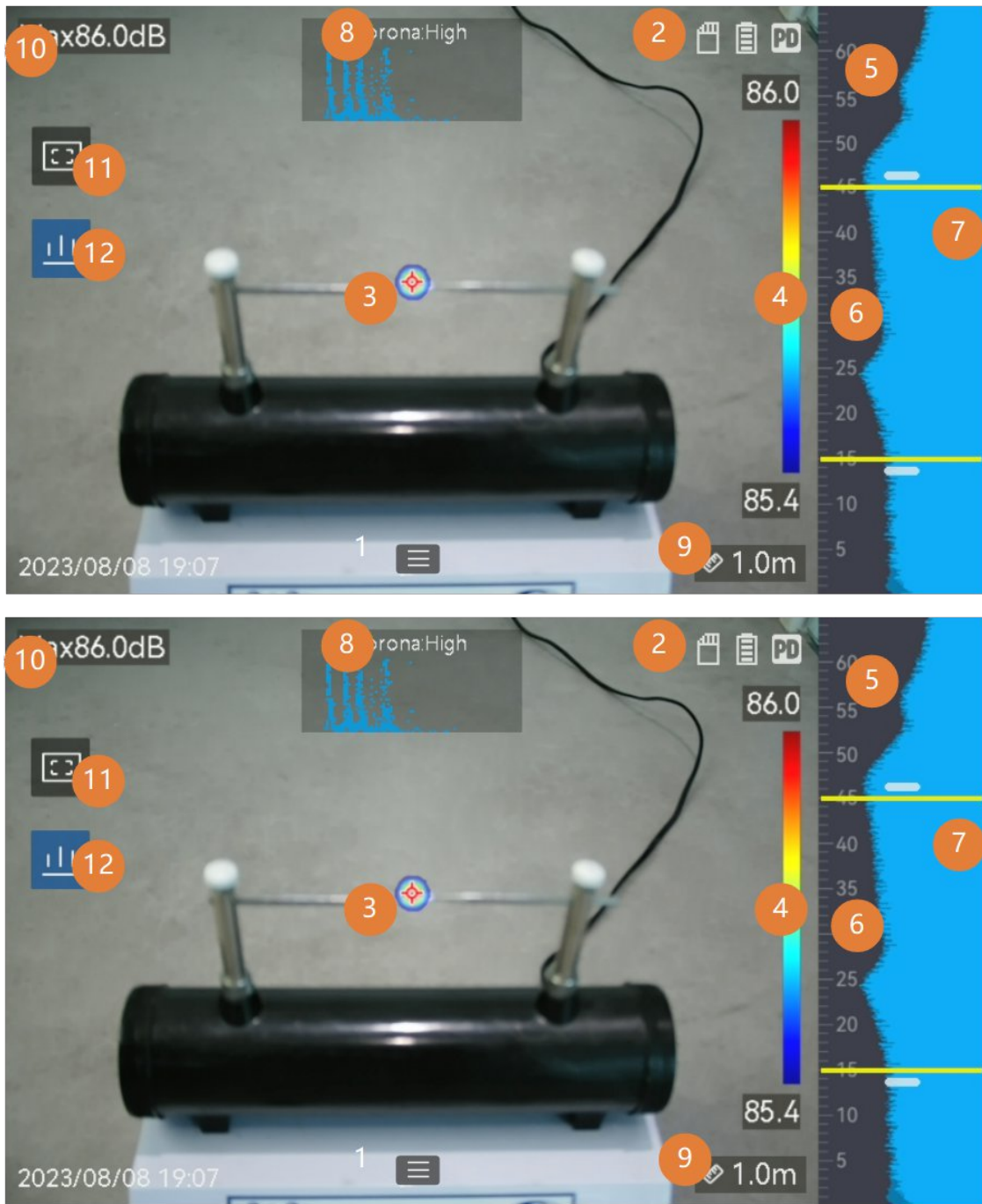

Table 3-1 Live View Interface Description

No.	Part Name	Function
1	Menu Icon	Tap on the icon to call the main menu.
2	Status Bar	Device working status icons are displayed in the bar. You can turn on/off the display from <b>Settings</b> → <b>Display Settings</b> → <b>Status Icons</b> .
3	Acoustic	The location and intensity of detected sound source

	Palette	are converted to palette colors overlaying on the visual image for easy observation. The size of palette stands for the intensity of the sound source. Bigger acoustic palette means higher sound intensity.
4	Intensity Scale (Palette Bar)	Intensity scale (palette bar) shows the relation between displayed color and sound intensity. The value at the end of the bar stands for the maximum and minimum intensity of the set frequency range. See 4.3.1 Set Palette Color for setting instructions.
5	Frequency Band	Shows the supported frequency band of the device.
6	Selected Frequency Band / Target Frequency Range	The sound intensity of this frequency band is detected and converted to acoustic palette.  See 4.2 Select Frequency Range for instructions.
7	Dynamic Intensity of All Frequencies	Shows the intensity change of supported frequencies.
8 & 12	PRPD and its Control Icon	Only available in PD mode. Tap on icon (12) to display phase resolved partial discharge (PRPD) diagram for better PD activity diagnosis. Tap on PRPD diagram (8) to enlarge the display.
9	Sound Source Distance	Shows the set distance of sound source. See 4.4 Set Sound Source Distance for setting instructions.
10	Maximum Intensity	Stands for the detected maximum intensity of the scene. See 4.6.1 Mark and Display Peak Intensity for setting instructions.
11	Regional Detection Frame	Tap on the icon to show a frame in the middle of the screen. The device only detects sound sources in the frame to reduce interference from less interesting areas. See 4.6.2 Regional Detection Frame for more information.
13	Gas Leakage Info.	Only available in LD mode. Shows detected gas leakage estimation. See 4.1.2 Gas Leakage Estimation for more information.

### 3.6.2 Menu

In the live view interface, tap  or press **OK** to show the menu bar, and swipe down to call the swipe-down menu.

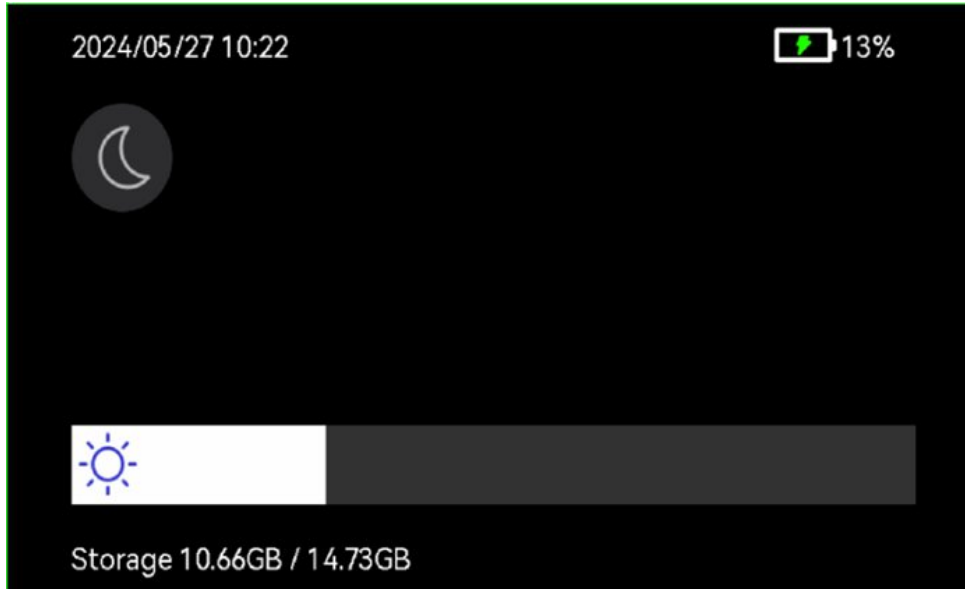









Figure 3-6 Main Menu and Swipe-Down Menu

Table 3-2 Menu Description

Icon	Function
	Detection mode switch. Partial Discharge Detection (PD) and Gas Leakage Detection (LD) are supported.
	Adjusts detection sensitivity. A bigger value means higher sensitivity. See 4.5 Set Detection Sensitivity for setting instructions.
	Pre-defined target frequency ranges for quick switching.
	Distance to sound source.
	Local albums of captured images and videos. See 6.3 View and Manage Local Files for setting instructions.
	Settings of all device function.
	Tap to switch menu themes between dark and light.
	Swipe to adjust screen brightness.

## 4 Acoustic Wave Detection

The device supports acoustic wave detection among different frequency ranges. Detected sound source is marked acoustic palettes to show its dynamic location and intensity.



### 4.1 Set Detection Mode

The device supports partial discharge detection (PD) and gas leakage detection (LD).

Application of PD and LD

Detection Mode	Application
Partial Discharge (PD)	Often used in electrical equipment and facility inspection. It detects abnormal partial discharges faults and instructs maintenance activities.
Gas Leakage (LD)	Often used in gas leakage detection of gas pipelines, tanks, valves, etc.

#### Steps

1. In the live view interface, tap  or press **OK** to show the menu.
2. Select  to switch detection modes.



Switch Detection Mode

#### 4.1.1 Partial Discharge Types and Levels

When detecting a partial discharge sound source, the device automatically identifies the type and strength level, and display the result on screen.

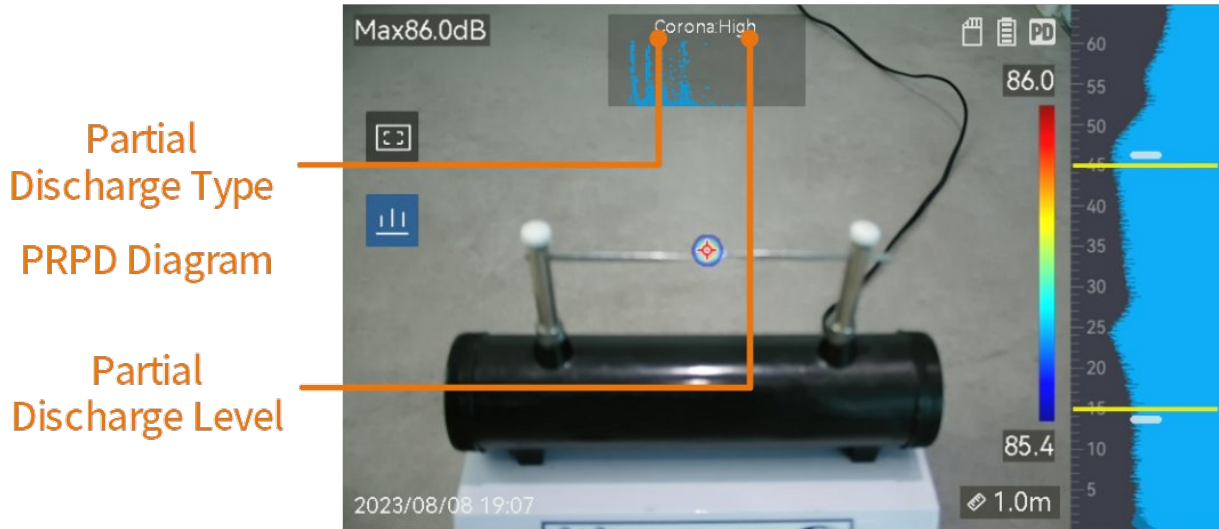

The explanation of screen display and the recommended handling are shown in the following tables.

Partial Discharge Types

Partial Discharge Types	Explanation
Corona	Corona discharge occurs on the sharp surface of a conductor surrounded by gas. It usually happens in electrical systems like high-voltage power lines, transformers, or electrical motors.
Floating	Floating discharge, one of arcing discharges, happens when the electrical current flows through the conducting path created by voltage difference between two conductors. It might occur in various situations, such as high-voltage power transmission systems, electrical switches, circuit breakers, and welding equipment.
Surface	Surface discharge refers to the electrical discharge travels along the surface of insulation. It is primarily caused by the contamination and weather conditions like high humidity, of the insulator surface. It often occurs in high-voltage equipment, such as transformers, cables, switch gear, and motors.
Particle	Particle discharge refers to the partial discharge of electrical energy that interacts with metallic particles and debris present in the electrical systems. It can result from loose particles or particles generated by mechanical wear, corrosion, or degradation of insulation materials.

Noise	Other detected sound.
-------	-----------------------

If different types of partial discharges coexist in the scene, the most prominent partial discharge type shows in live view.

Partial Discharge Severity and Handling



Partial Discharge Severity	Recommended Handling
Normal	No observable/measurable deterioration.
Low	Minor deterioration which requires attention. Shorten inspection period and take maintenance actions when necessary.
Medium	Moderate deterioration. Locate and clean the Item during routine maintenance or carry out related electrical test of the item. Or use online monitor to monitor the discharge tendency.
High	Serious deterioration. Item cannot be returned to service without shut down or engineering advise.

**4.1.2 Gas Leakage Estimation**

Device estimates and displays leak rate, level and possible cost for reference according to the set time unit, unit price, and currency.

**Caution:** This product is designed to assess energy leakage to achieve energy savings. However, due to potential environmental factors that may impact detection accuracy, the estimations provided are approximate and for informational purposes only. It should be noted that the results presented by the devices are not a guarantee of actual energy savings or a recommendation, and may not accurately reflect the specific situation of your facilities.

**Steps**

1. In the live view interface, tap  or press **OK** to show the menu.
2. Select , and switch to LD.
3. Select , and go to **Acoustic Settings** → **Gas Leak Settings** to set Unit Price, Time Unit, and Currency.
4. Return to live view interface. Aim the device to a gas leak source, and the real-time estimation displays on screen.

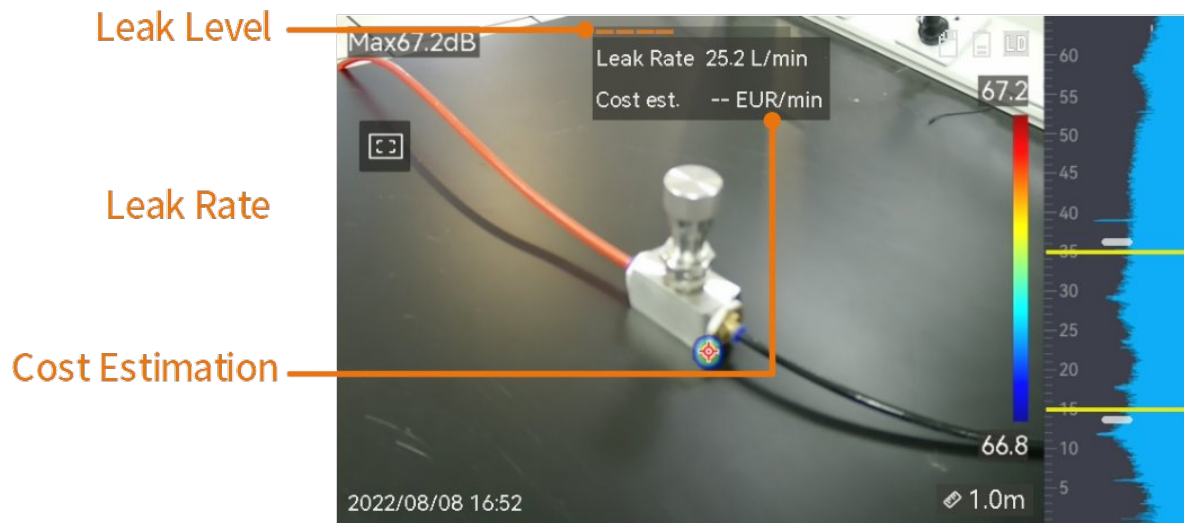

Gas Leak Estimation

## 4.2 Select Frequency Range

The S532 provides 3 types of frequency ranges:

- Range 1: 20 - 50 kHz (default)
- Range 2: 25 - 45 kHz
- Range 3: 45 - 65 kHz

Thereinto, the first 2 ranges are available for sound detection. The third range is reserved.

### Steps

1. Choose the one that better covers possible target frequencies from **Settings** → **Acoustic Settings** → **Frequency**.
2. Select a target frequency band, sound of which is visualized to acoustic palettes in the display for easy observation. You can switch among 3 pre-defined frequency ranges or adjust manually.

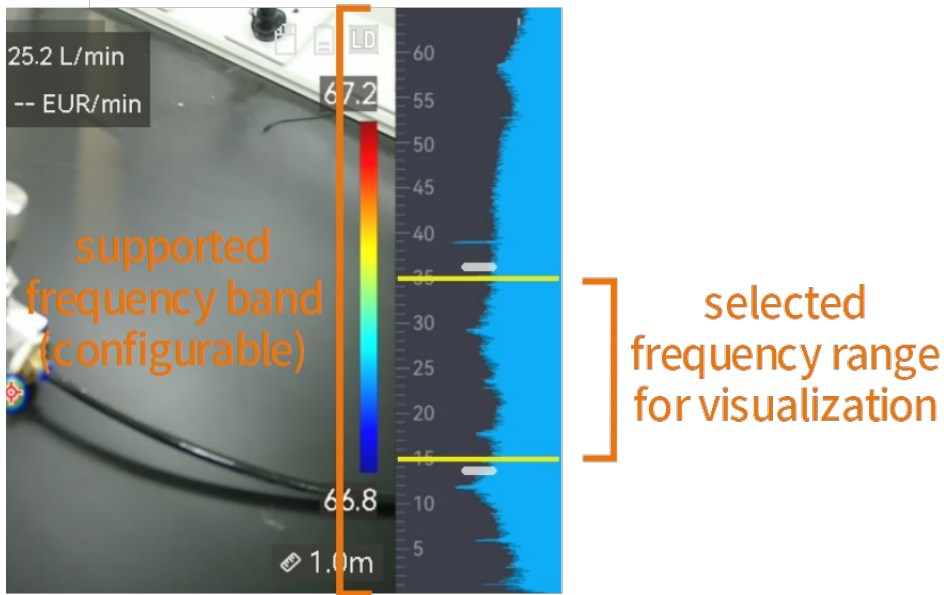

### 4.2.1 Switch among Pre-defined Target Frequency Ranges

#### Steps

1. In the live view interface, tap or press **OK** to show the menu.
2. Select and select a range option.





### 4.2.2 Set Target Frequency Range Manually



#### Steps

1. Select a subject for adjustment.

#### Selected Frequency Adjustment

Objective	Operation	Operation Result
Adjust the upper and lower limits together.	Press  once or tap the area between the yellow lines.	<p>The screenshot shows a spectrogram with a white horizontal line at 33.3 Hz and another at 16.9 Hz. Red bars are visible at these frequencies. The y-axis is labeled with 15, 20, 25, 30, and 33.3.</p>

<p>Adjust the upper limit only.</p>	<p>Press  twice or tap on the upper yellow line.</p>	
<p>Adjust the lower limit only.</p>	<p>Press  three times or tap on the lower yellow line.</p>	



2. Press/hold  and  to adjust values.
3. Press  to save and exit.

### 4.3 Set Acoustic Palettes

Acoustic palettes are the shaped colors overlaying the visual image indicating the location and strength of detected sound source. Palette color, opacity and intensity range of palettes are adjustable.

#### 4.3.1 Set Palette Color

##### Steps

1. Press **OK** in the live view interface to show the menu.
2. Select  from the main menu, go to **Acoustic Settings** → **Palettes**, and select a desired color combination.
3. Press  to save and exit.



##### Result

Acoustic palette overlaid above the sound source and palette bar change to the selected palette.

#### 4.3.2 Set Palette Opacity

You can view the acoustic palette and the visual images at the same time if the opacity is properly set.

##### Steps

1. In live view interface, tap  or press **OK** to show the menu.
2. Go to **Settings** → **Acoustic Settings** → **Level**, and select a desired level.
3. Press  to save and exit.

**Note:** The opacity level ranges from 0% to 100%. The lower the value is, the more transparent the acoustic palette is.







Level: 75% vs Level: 25%

### 4.3.3 Set Intensity Range for Palettes

Colors in palettes stand for different sound intensity values. Usually, the device automatically calculates intensity range for palettes. You can also manually set a fixed range if the auto palette display is not satisfactory.

- **Auto (default):** Device calculates the upper limit, lower limit, and the intensity delta automatically.
- **Manual:** Device calculates the upper limit and lower limit of intensity according to the set intensity delta and actual intensity of target sound source.





#### Steps

1. In the live view interface, tap  or press **OK** to show the menu.
2. Go to **Settings** → **Acoustic Settings** → **Intensity Range**, and press **OK** to switch to Manual.
3. Select **Intensity Delta** and press **OK**.
4. Press/hold  and  to adjust values.
5. Press  to save and exit.

## 4.4 Set Sound Source Distance

Distance to sound source helps to increase the acoustic wave detection accuracy.





### Steps

1. In live view interface, tap  or press **OK** to show the menu.
2. Select .
3. Adjust the distance value by pressing/holding  and  or tapping **<** and **>**.
4. Press  to save and exit.

## 4.5 Set Detection Sensitivity

Higher sensitivity means that sound source of lower intensity can be detected. Higher sensitivity also means that interferences are more easily detected and displayed.

### Steps

1. In the live view interface, tap  or press **OK** to show the menu.
2. Select .
3. Press  and  or tapping on screen to select a level. A bigger number means higher sensitivity.
4. Press  to save and exit.

## 4.6 More Tools

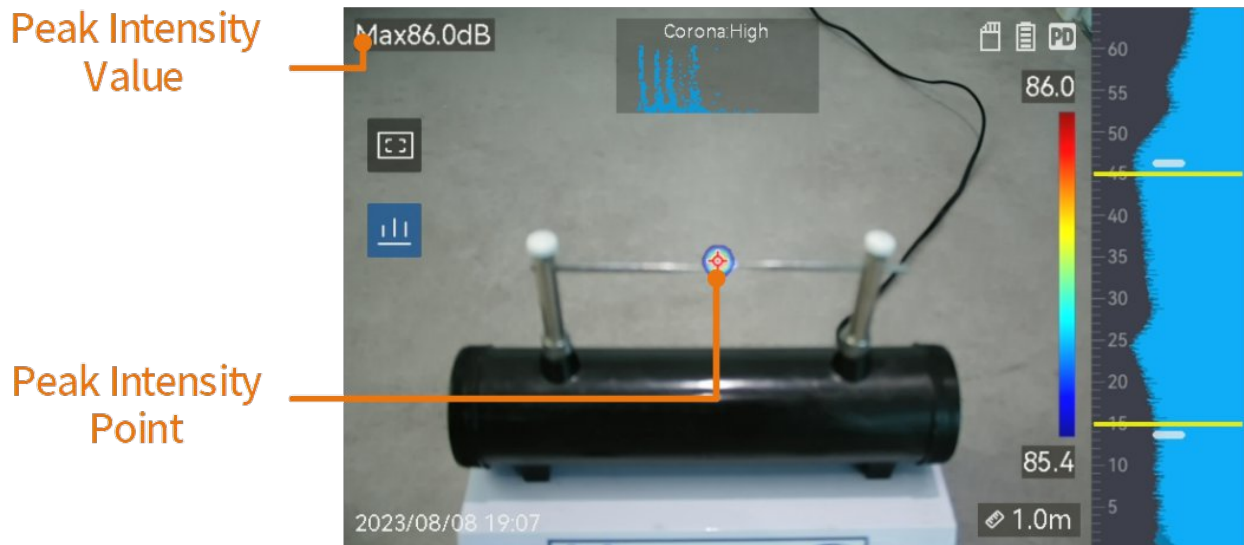

### 4.6.1 Mark and Display Peak Intensity

Mark peak intensity point with  and display the peak intensity value on screen.



Mark Peak Intensity

### Steps

1. In live view interface, tap  or press **OK** to show the menu.
2. Go to Settings → Acoustic Settings → Sound Intensity Display.
3. Enable **Peak**.
4. Press  to save and exit.

### 4.6.2 Regional Detection Frame

If the target sound source is small and there is sound interference around, enable the regional detection frame and aim the frame at the target. Sound detection is only carried out in the framed area.

Tap  to turn on/off regional detection frame.

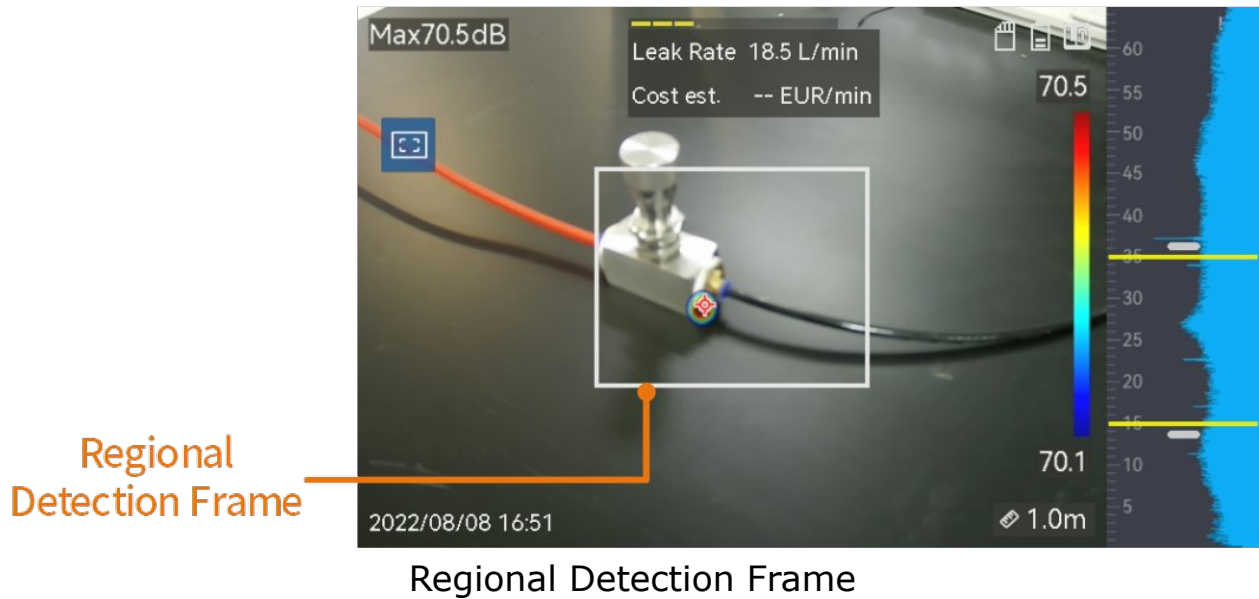

Regional Detection Frame



### 4.6.3 Show Multiple Sound Sources

Usually, the device only displays acoustic palettes at the strongest sound source. If you want to see the other sound sources in the scene, turn on **Multiple Sources** from **Settings** → **Acoustic Settings** → **Multiple Sources**.

## 5 Display Settings

### 5.1 Set Screen Brightness

#### Steps





1. In live view interface, tap  or press **OK** to show the menu.
2. Select  from the main menu, go to **Device Settings** → **Screen Brightness**.
  - Auto: The device adjusts screen brightness automatically according to the ambient brightness.
  - Manually: Drag the brightness adjustment slider to the left or right to manually adjust screen brightness.

**Note:** You can also manually adjust brightness from the swipe-down menu.



## 5.2 Adjust Digital Zoom



The device supports 1× to 8× digital zoom.

- In the live view interface, hold  or  to zoom in or zoom out by 1× continuously.
- In the live view interface, press  or  to zoom in or zoom out by 0.1× precisely.

## 5.3 Display OSD Info.

OSD information informs you of the status, time and date, and other information of the device in the live view interface.



### Steps

1. In live view interface, tap  or press **OK** to show the menu.
2. Go to **Settings** → **Display Settings**.
3. Tap  or press **OK** to select the on-screen information.
4. Press  to save and exit.

## 5.4 Set Grayscale of Visual Image

The colored live view image turns to black and white if grayscale image is enabled. The black and white image makes colored acoustic palettes more prominent for observation.

### Steps

1. In live view interface, tap  or press **OK** to show the menu.
2. Go to Settings → Display Settings.
3. Tap  to enable **Grayscale Image**.
4. Press  to save and exit.

## 6 Picture and Video

Insert a memory card into the device, and then you can record videos, capture images, and mark and save important data.

### Note:

- Device does not support capturing or recording when the menu is shown.
- When the device is connected to your PC, it does not support capturing or recording.
- Go to **Settings** → **Capture Settings** → **Filename Header**, you can set the filename header for capturing or recording to distinguish the files recorded in a specific scene.
- Go to **Settings** → **Device Settings** → **Device Initialization** to initialize the memory card if needed.

### 6.1 Capture Picture

Operate the device to capture live images and save the images in local albums.

#### Before You Start

Make sure that there is a working memory card mounted in your device. See Appearance section to locate the memory card slot of your device.

#### Steps

1. Set a capture mode and pull **Trigger** in live view interface to capture images. There are 3 modes available. Each mode requires different operations.
  - 1) Go to **Settings** → **Capture Settings** → **Capture Mode**.
  - 2) Select a mode.
    - **Capture One Image:** Pull **Trigger** once to capture one image.
    - **Continuous Capture:** Set the continuous capture amount after selecting this mode. Pull **Trigger** in live view, and device captures the set number of images continuously.
    - **Scheduled Capture:** Set the interval for scheduled capture after selecting this mode. Pull **Trigger** in live view, and the device captures images according to the set interval. Pull **Trigger** again or press ↶ to stop capturing.

- 3) Press  to return to the live view interface.
  - 4) Aim the lens at your target and pull **Trigger** to capture images.
2. **Optional:** After capturing, you can tap the thumbnail of the captured image to view and edit the image.

### What to do next

- Go to albums to view and manage files and album folders. See Manage Albums and Manage Files for operation instructions.
- To edit saved images, see Edit Files for operation instructions.
- You can connect your device to PC to export local files for further use. See Export Files.

## 6.2 Record Video

You can record videos of the target. The recorded video and audio are saved in the memory card.

### Steps

1. In the live view interface, hold the trigger to start recording. The recording status icon and time icon appear.
2. When you finish, pull the trigger again to stop recording. The recorded video will be saved automatically and exit.

**Note:** You can also press **OK** or  to stop recording.

3. Refer to Export Files to export the snapshots.

**Note:** The video format is MP4 format. You can play videos on the device or export to the compatible players to play.

## 6.3 View and Manage Local Files

Device captured images and videos are saved in local albums. You can create, delete, rename and set an album as the default saving album. For files, operations, such as browsing, moving and deleting, are available.

### Steps

1. Enter album.
  - In live view, press  to enter albums.



- In live view, press **OK** to call the main menu, and select  to enter albums.
2. To create, rename, delete and set an album as the default saving album, see Manage Albums for instructions.
  3. For file operations, such as, moving or deleting a file, see Manage Files for instructions.
  4. To modify an image, for example, editing the text or voice notes saved with the images, see Edit Files for instructions.

### 6.3.1 Manage Albums

You can create several albums to manage captured images and video files on your device. Newly captured images and videos are saved in the





**Default Saving Album** .

#### Steps

1. Enter albums.
  - In live view, press  to enter albums.
  - In live view, press **OK** to call the main menu, and select  to enter albums.
2. Create an album.
  - 1) Tap **+** in upper right corner to add an album.
  - 2) Edit the album name.
  - 3) Press **✓** to save the album.
3. Rename, delete or set an album as the default saving album.
  - 1) Select an album and press **OK**.
  - 2) Tap **...** in upper right corner of the screen.
  - 3) Select Set as Default Saving Album, Rename or Delete as required.
- 4) The album icon turns to  when it is set as the default saving album.







### 6.3.2 Manage Files

#### Steps

1. Enter albums.
  - In live view, press  to enter albums.
  - In live view, press **OK** to call the main menu, and select  to enter albums.
2. Select an album and press **OK**.
3. Browse the image and video files.
  - 1) Select a file and press **OK**.
  - 2) Press  and  to browse the previous or the next file.
  - 3) Press **OK** to call the operation menu to check more available operations. File formats and their supported operations are shown below.

#### File Formats and Operations



File Type	Format	Descriptions
Images	File Name.pd.jpeg File Name.ld.jpeg	Editing text and voice notes, moving files, checking basic information, and deleting files are supported on device.
Videos	File Name.pd.mp4 File Name.ld.mp4	Playing, moving and deleting video files are supported on device.

4. Delete several files.
  - 1) In an album, tap  in the upper right corner of the screen.
  - 2) Press  and  to select a file and press. If you want to select all files, tap  in the upper right corner. If you want to cancel all selection, tap .
  - A selected file displays with a  in its upper right corner.
  - 3) Tap **Delete**. Files are deleted after confirmation.







### 6.3.3 Edit Files

Editing the text or voice notes saved with the images.

#### Steps

1. Enter albums.
  - In live view, press  to enter albums.
  - In live view, press  to call the main menu, and select to enter albums.
2. Select an album and press **OK**.
3. Select a file and press **OK** to call the editing menu.
4. Select an option and complete corresponding operations.

#### Editing and Managing Images

Icon	Description
	Editing text note. Add a new text note or change the existing note and press <b>OK</b> to save the settings.
	Editing voice note. You can add a new voice note, play or delete an existing voice note. If the file already has a voice note, tap to play or delete the note. If the file has no voice note attached, press <b>OK</b> or tap  to record one.
	Show basic information of the file, for example, the saving time and resolution.
	Delete file.
	Play video.

## 6.4 Export Files

Connecting the device to your PC with supplied cable, you can export the recorded videos and captured snapshots.

### Notes:

- Plug the type-C male connector of USB cable to the device and the other type-A connector to PC.
- You can export the files by inserting the memory card to your PC which has a card slot.

### Steps

1. Open the cover of cable interface.
2. Connect the device to your PC with cable and open the detected disk.
3. Select and copy the videos or snapshots to PC to view the files.
4. Disconnect the device from your PC.

**Note:** You can play the recorded videos using the default players.

## 7 Maintenance

### 7.1 View Device Information

Go to **Settings** → **Device Settings** → **Device Information** to view the device information.

### 7.2 Set Language

Go to **Settings** → **Device Settings** → **Language** to set system language.

### 7.3 Set Time and Date

#### Steps

1. Press **OK** to show the menu in the live view interface.
2. Go to **Settings** → **Device Settings** → **Time and Date**.
3. Set the date and time.
4. Press ↩ to save and exit.

**Note:** Go to **Settings** → **Display Settings** to enable or disable time and date on-screen display.

### 7.4 Upgrade Device

#### Before You Start

- Please contact customer service and technical support to get the upgrade file first.
- Make sure that the device battery is fully charged.
- Make sure that Auto Power-off function is turned-off to avoid accidental suspension during upgrading.
- Make sure that a memory card has been installed to the device.
- Download the upgrade package from [www.suto-itec.com](http://www.suto-itec.com) and store it in your PC.
- Unzip the package to the firmware file.

#### Steps

1. Power on the S532.
2. Open the lip on the top of the S532.

3. Connect the device to your PC with the supplied type-C to type A cable. The USB icon is shown on your PC.
4. Copy the upgrade file and paste it to the root directory of the device.
5. Eject the USB drive from the desktop of your PC and disconnect the device from your PC.
6. Power off the device and power on it. The device will upgrade automatically. The upgrading process will be displayed in the main interface.

**Note:** After upgrading, the device reboots automatically. You can view the current version in **Settings** → **Device Settings** → **Device Information**.

## 7.5 Restore Device

You can default to the device in the factory settings.

**Note:** This function should be used with caution.

### Steps

1. Press **OK** to show the menu in the live view interface.
2. Go to **Settings** → **Device Settings** → **Device Initialization**.
3. Select **Restore Device**. A prompt appears.
  - **OK:** Tap **OK** to initialize the device.
  - **Cancel:** Tap **Cancel** to exit and return to the previous menu.

---

**SUTO iTEC GmbH**

Grißheimer Weg 21  
D-79423 Heitersheim  
Germany

Tel: +49 (0) 7634 50488 00  
Email: [sales@suto-itec.com](mailto:sales@suto-itec.com)  
Website: [www.suto-itec.com](http://www.suto-itec.com)

**SUTO iTEC (ASIA) Co., Ltd.**

Room 10, 6/F, Block B, Cambridge Plaza  
188 San Wan Road, Sheung Shui, N.T.  
Hong Kong

Tel: +852 2328 9782  
Email: [sales.asia@suto-itec.com](mailto:sales.asia@suto-itec.com)  
Website: [www.suto-itec.com](http://www.suto-itec.com)

---

**SUTO iTEC Inc.**

5460 33rd St SE  
Grand Rapids, MI 49512  
USA

Tel: +1 (616) 800-7886  
Email: [sales.us@suto-itec.com](mailto:sales.us@suto-itec.com)  
Website: [www.suto-itec.com](http://www.suto-itec.com)

---

All rights reserved ©

Modifications and errors reserved

S532\_IM\_EN\_V2025-1-1