

Instruction and Operation Manual

S606

Stationary Breathing Air Quality Analyzer



Dear Customer,

Thank you for choosing our product.

Please read the manual in full and carefully observe operating instructions stated before you start up the device. The manufacturer cannot be held liable for any damage that occurs as a result of non-observance or non-compliance with this manual.

Should the device be tampered with in any manner other than a procedure which is described and specified in the manual, the warranty is void and the manufacturer is exempt from liability.

The device is destined exclusively for the described application.

SUTO offers no guarantee for the suitability for any other purpose. SUTO is also not liable for consequential damage resulting from the delivery, capability or use of this device.

Revision: 2026-1



Last modifications: January, 2026

Table of Contents

1	Safety Instructions.....	5
2	Registered Trademarks.....	8
3	Application.....	8
4	Features.....	8
5	Technical Data.....	9
5.1	General Data.....	9
5.2	Operating Conditions.....	9
5.3	Relay Module (Optional).....	11
6	Dimensions.....	12
7	Installation on Site.....	13
7.1	Select Installation Location.....	13
7.2	Mount on the Wall.....	14
7.3	Electrical Connections.....	15
7.3.1	Power Supply.....	16
7.3.2	RS-485 Networking (Modbus/RTU).....	16
7.3.3	TCP/IP Networking (Modbus/TCP).....	17
7.3.4	Alarm Outputs.....	17
7.3.4.1	Built-in Relay.....	17
7.3.4.2	Optional Relay Module.....	18
7.4	Compressed Air Connection.....	19
7.5	Water Filling Connector.....	20
7.5.1	Fill Water to the Humidifier.....	21
7.6	Calibration Connector.....	22
8	Setup.....	22
9	Operation and Configuration.....	23
9.1	Main Screen.....	24
9.1.1	Quick Buttons and Icons.....	24
9.1.2	Icons in the Status Bar.....	25
9.2	Value Screen.....	25
9.3	Graphic Screen.....	25
9.4	Menu.....	26
9.4.1	Sensor Settings	27
9.4.2	System Setting.....	28
9.4.3	Service Company Information.....	29
9.4.4	Calibration of Gas Sensors.....	29
9.4.5	Files.....	30
9.4.6	Logger Setting.....	31
9.4.7	Alarm Setting.....	32
9.4.8	Communication.....	34
9.5	Configure S4A Remote Connection.....	34
9.6	SIM Card Requirement for 4G/LTE Option.....	37
9.6.1	Data Traffic.....	38
9.6.2	PIN Code Protection.....	38
9.7	Export Files via the S4A Software	38
10	Software Installation.....	40

11	Firmware Updates.....	41
12	Calibration.....	43
12.1	Calibration for DP Sensor and Oil Sensor.....	43
12.2	Calibration for O ₂ ,CO, CO ₂ Sensor.....	43
12.2.1	Calibration Gases.....	44
12.2.2	Calibration Procedure.....	45
13	Optional Accessories.....	50
14	Maintenance.....	50
15	Disposal of Waste.....	51
16	Warranty.....	51
17	Appendix - Modbus Holding Register Table.....	52
17.1	Modbus Interface.....	52
17.2	Modbus Register Table.....	54
17.3	Unit and Resolution.....	58

1 Safety Instructions

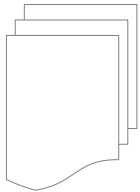

Please check if this instruction manual matches the product type.

Please observe all notes and instructions indicated in this manual. It contains essential information which must be observed before and during installation, operation and maintenance. Therefore this instruction manual must be read carefully by the technician as well as by the responsible user / qualified personnel.

This instruction manual must be available at the operation site of the flow sensor at any time. In case of any obscurities or questions, regarding this manual or the product, please contact the manufacturer.



WARNING!

Compressed air!

Any contact with quickly escaping air or bursting parts of the compressed air system can lead to serious injuries or even death!

- Do not exceed the maximum permitted pressure range. (See sensors label and/or the specifications written in this manual.)
- Only use pressure tight installation material.
- Avoid that persons get hit by escaping air or bursting parts of the instrument.
- The system must be pressure less during maintenance work.



WARNING!

Voltage used for supply!

Any contact with energized parts of the product may lead to an electrical shock which can lead to serious injuries or even death!

- Consider all regulations for electrical installations.
- The system must be disconnected from any power supply during maintenance work.
- Do not exceed the permitted operating parameters as specified in the data sheet, this manual or written on the instrument.
- Make sure the product is operated in its permitted limitations.

- Do not exceed or undercut the permitted storage and operation temperature, pressure and humidity.
- The product should be maintained and calibrated frequently, at least annually. For more information, contact customer support.

General safety instructions

- It is not allowed to use the product in explosive areas.
- Please observe the national regulations before/during installation and operation.

Remarks

- It is not allowed to disassemble the product.
- Always check the compressed air connectors in terms of stability and tightness.



ATTENTION!

Measurement values can be affected by malfunction!

The product must be installed properly and frequently maintained. Otherwise it may lead to wrong measurement values, which can lead to wrong results.

- The instrument must be operated within or better than compressed air quality Class 5.5.4 according to the ISO8573-1. If the air quality cannot reach the specified Class, the device may show wrong measurement values or even may get damaged.
- Do not exceed the maximum operation temperature or pressure.
- Avoid condensation inside the instrument caused by the supplied air or gas because it harms the instrument and affects the accuracy.
- It is recommended that before any operation you examine the instrument in terms of the measurement accuracy and deviations. To do this, you may use high efficiency filters for oil vapor and particle, and the instrument should show low values close to zero. Additionally, it is recommended you examine the dew point measurement to ensure it is working correctly. To do this, you may use a dry gas with a defined dew point value which should be reached within several minutes. Or you may use any reference meter. Only after doing these examinations, you can rely on the measurement results after the instrument have been used for other measurement cycles.

- Always perform a visual inspection in prior to every measurement before connecting compressed air. If any loose objects are found, do not connect the compressed air because it may lead to a damage or injuries.

Storage and transportation

- Make sure that the transportation temperature is between -10°C ... $+50^{\circ}\text{C}$.
- For transportation it is recommended to use the packaging which comes with the sensor.
- Please make sure that the storage temperature of the sensor is between -10°C ... $+50^{\circ}\text{C}$.
- Avoid direct UV and solar radiation during storage.
- For the storage the humidity must be $<90\%$, no condensation.



ATTENTION!

Equipment may get damaged!

Please make sure that your measuring point is free of excessive contamination/dirt. This should be maintained before every measurement.

- Observe the measuring point always before measurement if it is free of contamination like water drops, oil drops or other rough contamination.
- Should water hit the inner electronics, the sensors could be seriously damaged.
- Any rough contamination of particles, water, oil or other impurities may damage the instrument or affect the accuracy.
- Check your measurement point with the enclosed test kit, by purging air in prior to the use of the instrument through the test kit. A clean tissue may help to identify oil, water or any other lubricants in the air.

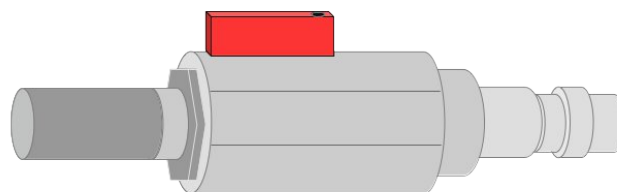

2 Registered Trademarks

SUTO®	Registered trademark of SUTO iTEC
MODBUS®	Registered trademark of the Modbus Organization, Hopkinton, USA

3 Application

The S606 is a stationary device to continually monitor the breathing air quality. It can measure O₂, CO, CO₂, H₂O, Oil, and ensures the breathing air quality to meet the international standard such as EN 12021, CSA Z180.1-0, and more. The S606 provides a safe and healthy environment for the operator.

The S606 is mainly used in the industrial environment. It can not be used in hazardous or explosive environment and it is not suitable for permanent outside applications.

4 Features

- All-in-one device measures O₂, CO, CO₂, H₂O, and Oil.
- Measures additionally the temperature and pressure.
- Visible alarm notification and flexible alarm threshold configuration.
- Modbus/RTU (RS-485) and Modbus/TCP (Ethernet) interface are supported.
- Remote monitoring can be easily realized through a 4G dongle and the free software.
- User-friendly display with all important information.
- Compressed air connection via 6 mm tube.
- Integrated data logger saves data for later analysis.
- Robust housing and easy installation.

5 Technical Data

5.1 General Data

	
Power supply	100 ... 240 VAC, 50/60 Hz, 50 VA
Display	Touchscreen, Size: 5" Resolution: 800 x 480 px
Data logger	Internal, 30-million values
Interface	USB Ethernet (Modbus/TCP) RS-485 (Modbus/RTU) 4G/LTE Modem (Optional)
Output	One internal Relay One 8-channel relay module (optional)
Process connection	Micro quick connector, full pass through, male (1.5 m hose with coupling included)
Housing material	Sheet steel, powder-coated on the outside
Protection class	IP55 (cover closed)
Dimension	600 x 600 x 250 mm
Approvals	FCC, EC
Weight	34 kg

5.2 Operating Conditions

Measuring medium	Compressed breathing air
Humidity of the medium	< 40%, non condensation
Temperature of the medium	0°C ... +50°C
Operation pressure	0.4 ... 1.5 MPa(g) For higher pressure need pressure reducer externally
Storage & Transport temperature	-10°C ... + 50°C
Ambient temperature	0°C ... +50°C
Ambient humidity	0... 90% rH
Sample flow rate	6 LPM@0.4 MPa(g), depends on input pressure
Sample rate	1 sample/sec

5.3 Measurement Data

Oil Vapor	
Measuring range	0.001 ... 5.000 mg/m ³ (Based on 1000 hPa(a), 20°C, 0% relative humidity)
Accuracy	5% of reading ± 0.003 mg/m ³
Resolution	0.001 mg/m ³
Sensor principle	Photo ionization detector
UV lamp lifetime	9,000 working hours
Oil Mist and Particle Sensor (Only for version S606-C)	
Measuring range	0.0 ... 10.0 mg/m ³ (Based on 1000 hPa(a), 20°C, 0% relative humidity)
Accuracy	15% of reading ± 0.1 mg/m ³
Resolution	0.1 mg/m ³
Sensor principle	Oil mist and Particle sensor
Sensor lifetime	> 5 years
O₂ Sensor	
Measuring range	0 ... 25%
Accuracy	±0.25% @25°C
Resolution	0.1%
Sensor principle	Optical oxygen sensor
Sensor lifetime	> 5 years
CO Sensor	
Measuring range	0 ... 20 ppm
Accuracy	±(5% of reading + 1 ppm)
Resolution	0.1 ppm
Sensor principle	Electrochemical sensor
Sensor lifetime	2 years
CO₂ Sensor	
Measuring range	0 ... 1000 ppm
Accuracy	±(1% of reading + 25 ppm)
Resolution	1 ppm
Sensor principle	NDIR sensor

Sensor lifetime	> 5 years
H₂O (dew point)	
Measuring range	-100 ... +20 °C Td / 0 ... 17458.6 mg/m ³
Accuracy	±1 °C Td (0 ... 20 °C Td) ±2 °C Td (-70 ... 0 °C Td) ±3 °C Td (-100 ... -70 °C Td)
Resolution	0.1°C Td
Sensor principle	QCM + Polymer
Sensor lifetime	> 10 years
Pressure Sensor	
Measuring range	0 ... 16 bar(g)
Accuracy	0.5% full scale
Resolution	0.01 bar
Sensor principle	Piezzo resistive pressure sensor

5.3 Relay Module (Optional)

Power input	10 ... 48 VDC
Power consumption	1.8 W @ 24 VDC
Number of output channels	8
Contact rating (Resistive)	0.5 A @ 120 VAC 0.25 A @ 240 VAC 1 A @ 30 VDC 0.3 A @ 110 VDC
Breakdown voltage	750 VAC (50/60 Hz)
Total switching time	10 ms
Maximum operating	50 operations / min
Mounting	Rail mounted

6 Dimensions

Dimensions in mm:

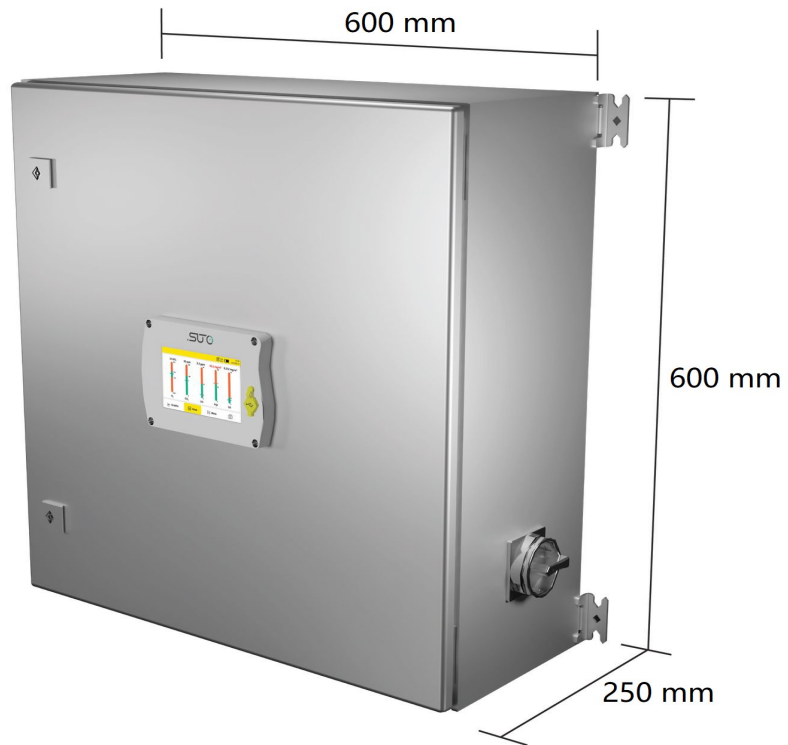

7 Installation on Site

Make sure that all components listed below are included in your package.

Qty.	Description	Item No.
1	S606 Stationary Breathing Air Quality Analyzer in a wall mountable cabinet	S606-I version: D500 0606 (with oil vapor sensor) S606-C version: D500 1606 (with oil mist and particle sensor)
1	USB OTG memory stick	A554 0087
1	Purge filter for pre-measurement (test kit)	A554 0604
1	6 mm Teflon hose with quick connector on one end and compressed air coupling on the other end, 1.5 m	A554 3316
1	M12 Connector	C219 0059
1	Operation and instruction manual	No P/N
1	Certificate of calibration	No P/N

If you need replacement materials from the list above or need further useful accessories, contact the manufacturer or your local distributor.

7.1 Select Installation Location

The device needs to be set up next to the measuring point.

The air supply tube should not be bended too strongly and should be installed with a big curve radius.



ATTENTION!

The device is designed to be operated indoors only.

7.2 Mount on the Wall

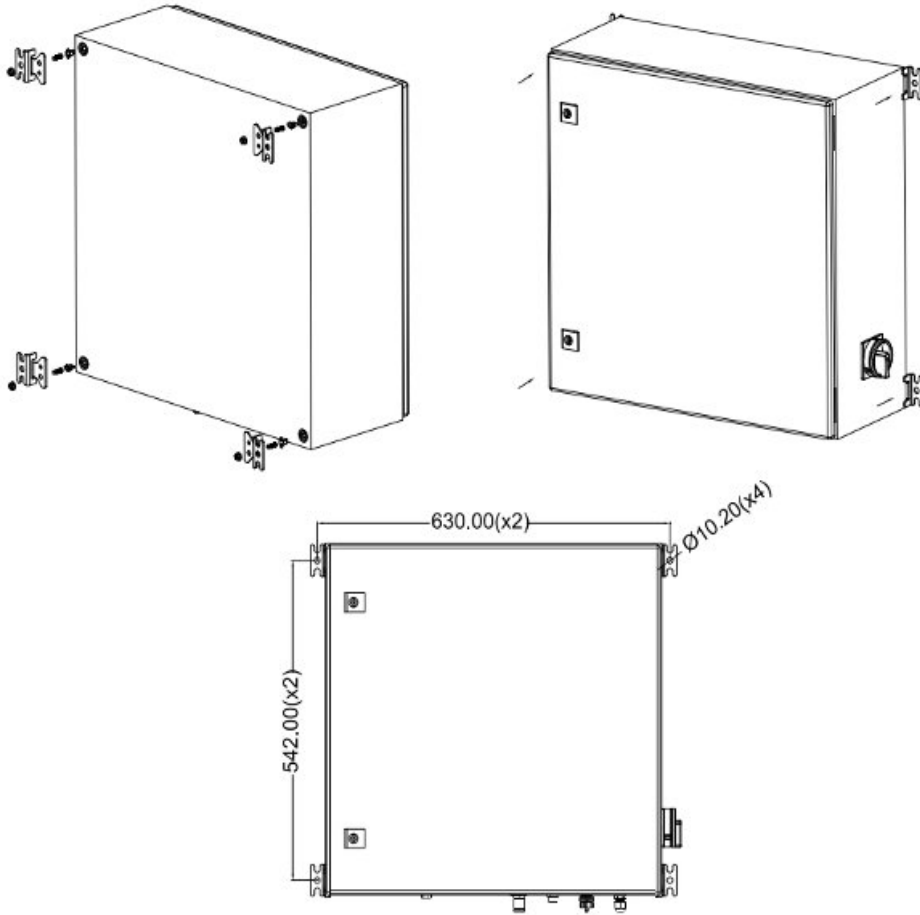

7.3 Electrical Connections

The S606 provides the following electrical connectors:

- The power supply is installed through a PG cable gland. The wires are connected to the internal screw terminals.
- One M12 connector for Modbus/RTU
- One RJ-45 Ethernet connector for Modbus/TCP
- One M12 connector for connecting the optional 4G LTE modem
- Two PG cable glands to connect to the optional relay output module

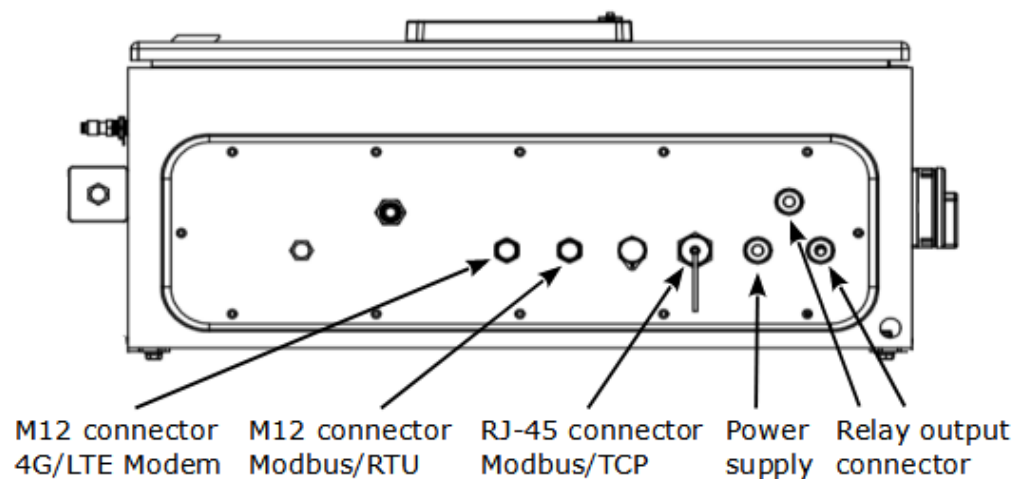

S606 bottom view

7.3.1 Power Supply



The power cable for the 230 VAC is connected to the terminals inside of the cabinet, as shown in the figure on the left.

An internal power supply (P/N: A554 0111) unit converts AC power to DC power, supplying power for the sensors.



ATTENTION!

Please observe voltage ranges and power levels!

7.3.2 RS-485 Networking (Modbus/RTU)

Through the M12 connector, the S606 can be connected to the RS-485 network over the Modbus/RTU protocol.

The RS-485 networking uses the following 3 pins in the M12 connector. The pin assignment is described below.

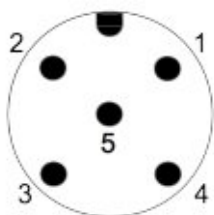

Pin No.	Assignment	Function
4	Data +	Modbus Data + signal
5	Data -	Modbus Data - signal
1	GND RS-485	Ground of RS-485

7.3.3 TCP/IP Networking (Modbus/TCP)

Through the RJ-45 connector at the bottom, the S606 can be connected to the TCP/IP network over the Modbus/TCP protocol.

Remove the protection cap and plug in the network cable (RJ-45).

7.3.4 Alarm Outputs

7.3.4.1 Built-in Relay

The S606 provides one relay (terminal I) for summary alarm output (AC 250V 6A/DC 30V 6A). The relay I is on the back of the S606. Before delivery, the Relay I has been wired with terminals 1, 2, and 3. You need to connect your alarm unit to the terminals 1, 2, and 3 for alarm function.

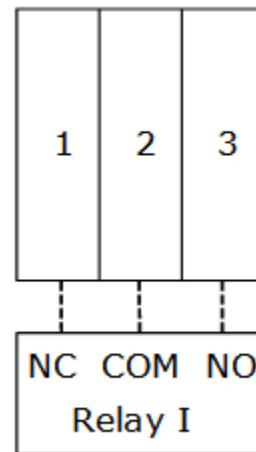

The example on the right shows a DC alarm unit wiring.

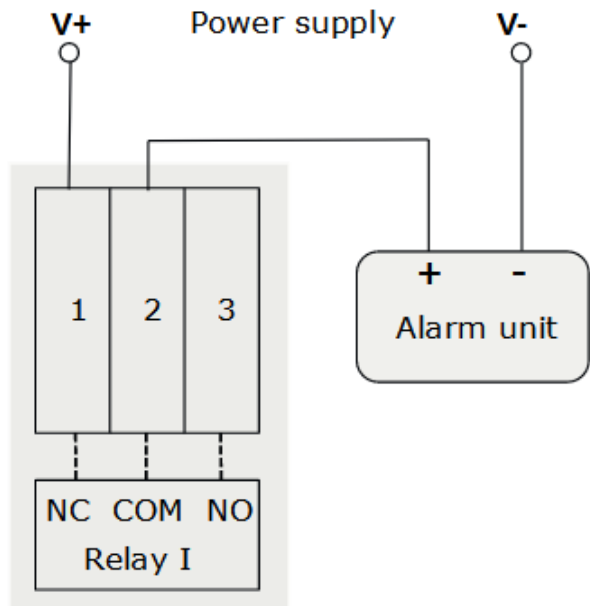

7.3.4.2 Optional Relay Module

If more relay outputs are required, an extended relay module is available. The relay module provides up to 8 relay outputs.

In the relay module, the RL0 ~ RL7 are relay terminals. All relays on the module can be configured as required to control external devices. For configurations, see the section 9.4.7.

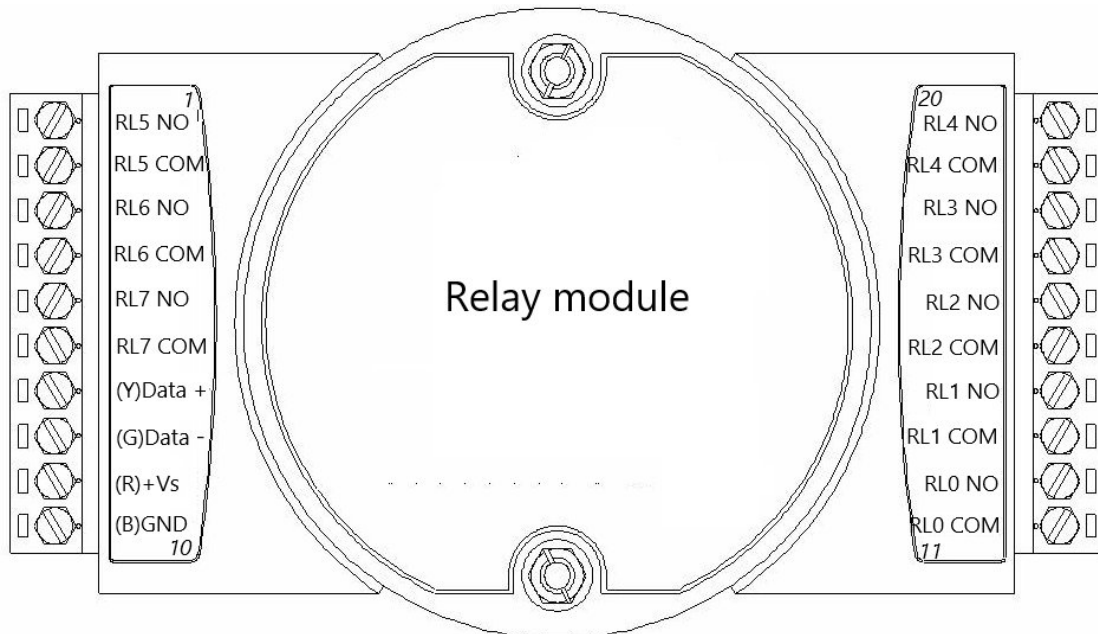

The example below shows a DC alarm unit wiring.

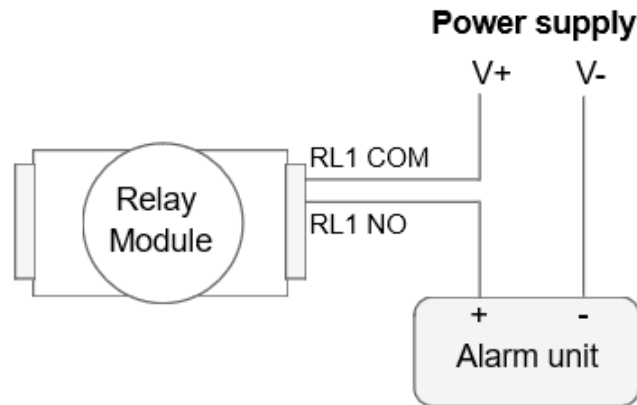

If you purchase the S606 with the relay module, the module is pre-installed in the S606 chassis with all necessary connections completed, and you only need to connect the external alarm device to the relay.

If you purchase the relay module for your existing S606, you can contact SUTO service team for detailed installation procedures.

7.4 Compressed Air Connection

The S606 offers a compressed air inlet at the bottom of the cabinet.

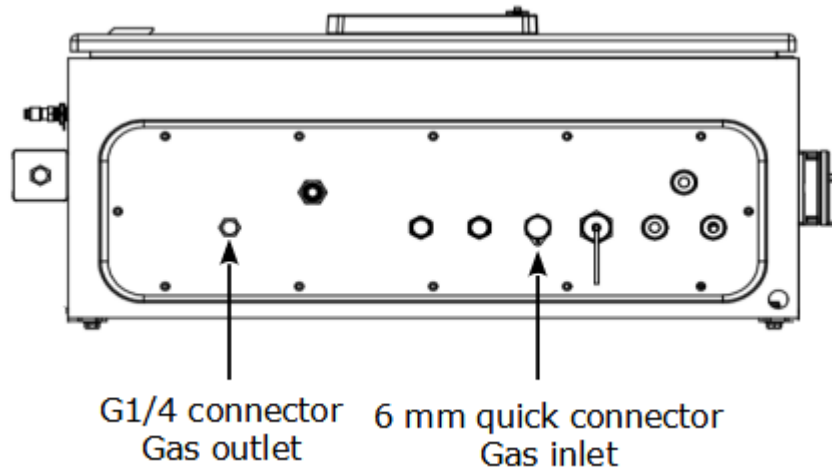

S606 bottom view



ATTENTION!

Permissible pressure!

Please observe the maximum permissible incoming pressure. It must be in between 0.4 and 1.5 MPa. If the pressure exceeds, the device will be damaged. If the pressure is too low, the volume flow will not be high enough, which will lead to wrong results.

**ATTENTION!**

Before you connect the device to your point of measurement, make sure that there is no rough contamination such as water / oil drops or heavy dust. This could damage the sensor units. Use the purge filter test kit to check the contamination.

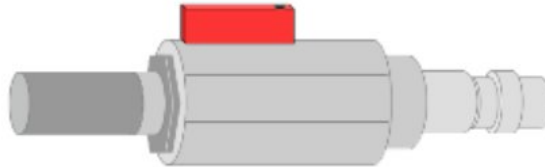

To check the measuring point, do the following:

1. Connect the purge filter test kit onto your measuring point.
2. Turn on the purge valve on the test kit and purge some air for a short period.
3. Check the filter in the test kit for high contamination of water, oil or dust.
4. If the filter is contaminated severely, stop using the S606 because this may lead to serious damage. If you are not sure, contact the manufacturer.

7.5 Water Filling Connector

To ensure that the measured gas is in a reasonable humidity, a humidifier is integrated in the S606, thus the CO sensor will not be damaged because the measured gas is too dry.

The water filling connector is located on the left side of S606. The water draining connector is located on the bottom of the S606.

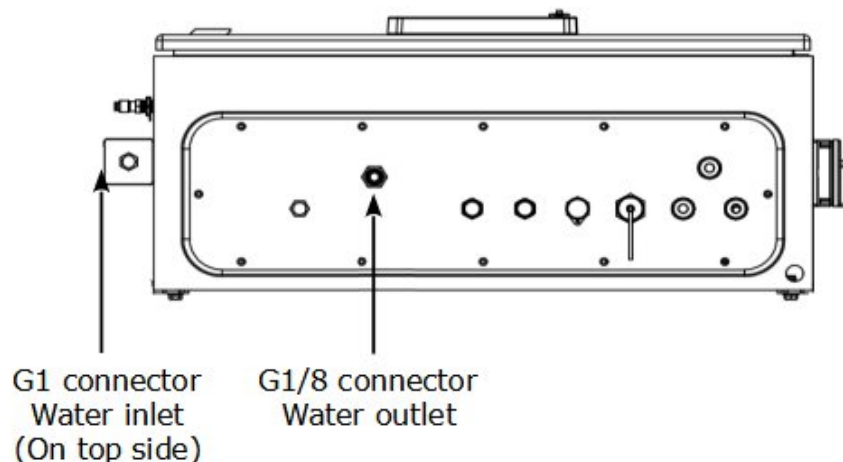

7.5.1 Fill Water to the Humidifier

When the water level is too low, the low water level indicator  in the status bar blinks, signaling the need to replenish water for the humidifier. The humidifier has a capacity of approximate 850 ml.

Follow steps below to fill water to the humidifier:

1. Fill a bottle or a cup with a sufficient amount of pure or demineralized water.
2. Remove the protection caps from the water inlet.
3. Pour the pure/demineralized water in the bottle or cup into the humidifier.
4. Monitor the water level indicator on the status bar during filling.
Stop when the high water level indicator  appears.
5. Secure the protection cap onto the water inlet.



ATTENTION!

Before using the product for the first time, ensure it is filled with pure or demineralized water. Use of unclean water may lead to scaling and contamination of sensors.

If the product remains unused for an extended period, drain the water.

Once the S606 is operational, promptly replenish the water to maintain functionality.

Under typical conditions, the humidifier lifespan is about 80 days. Inadequate water levels will make the S606 switch off!

7.6 Calibration Connector

The calibration connector is located on the left side of the S606. When the sensors need to be calibrated, remove the connector cap, connect the calibration hose and do the calibration. When the calibration is finished, put on the cap to avoid the dust or other substance entering. For more information see section 12 Calibration.

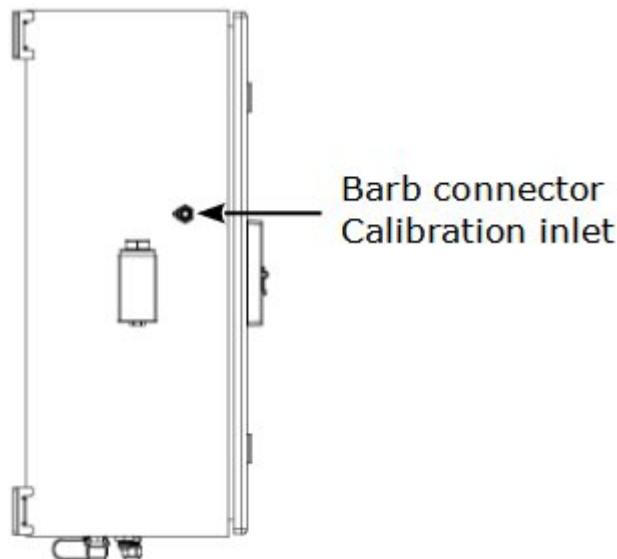

8 Setup

The S606 is configured ex-work and ready to measure when you get it. The setup settings are saved in the device and will not be lost even after a power failure.

The device also enables you to change the ex-work settings. For more information, see section 9.4.



ATTENTION!

If you have problems setting up the device, contact the manufacturer or your local dealer for assistance.

If a power failure occurs during the measurement, the measurement data will not be saved.

9 Operation and Configuration



When the S606 is powered on, the initialization screen is displayed with an active progress bar.

During the initialization, the device configures the sensors and runs initialization routines.

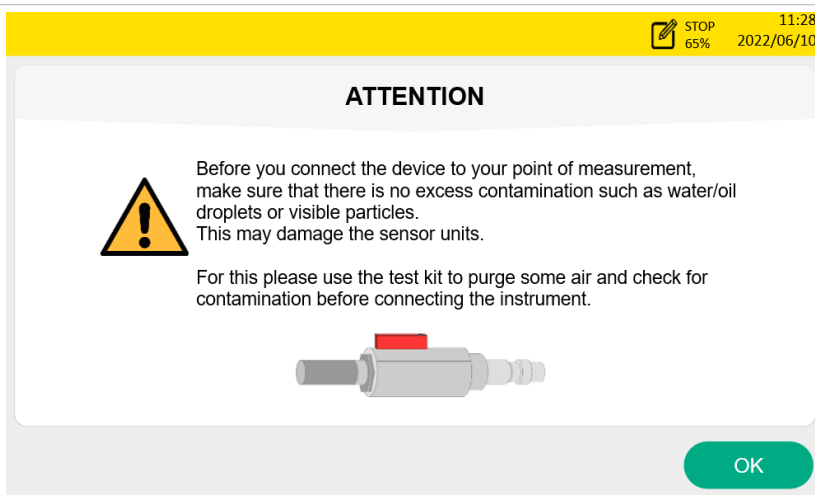

Attention displays after initialization, reminding user to use the test kit to avoid the sensor damaged because of the contamination.

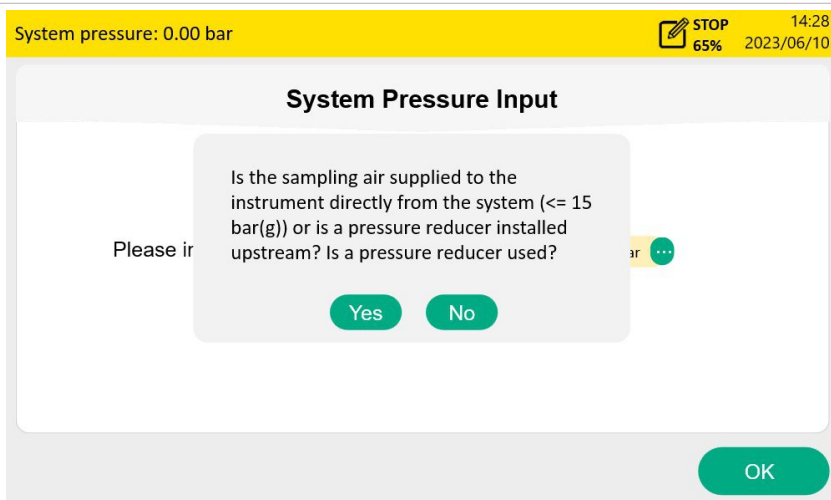

This screen asks if the system pressure needs to be entered. If you perform a high pressure measurement (>15 barg) through a pressure reducer, enter the system pressure before the pressure reducer. Click **Yes** to input the system pressure. Clicking **No** goes to the Value screen.

Note: If your system pressure is greater than 15 bar, make sure to enter your system pressure correctly, otherwise it may affect the measurement!

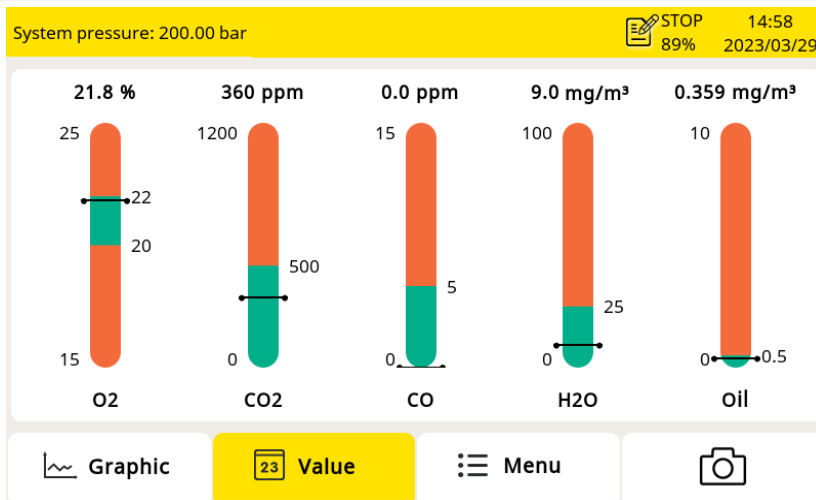

The value screen appears, as shown on the left.

9.1 Main Screen

The following figure shows the main screen in the value view.

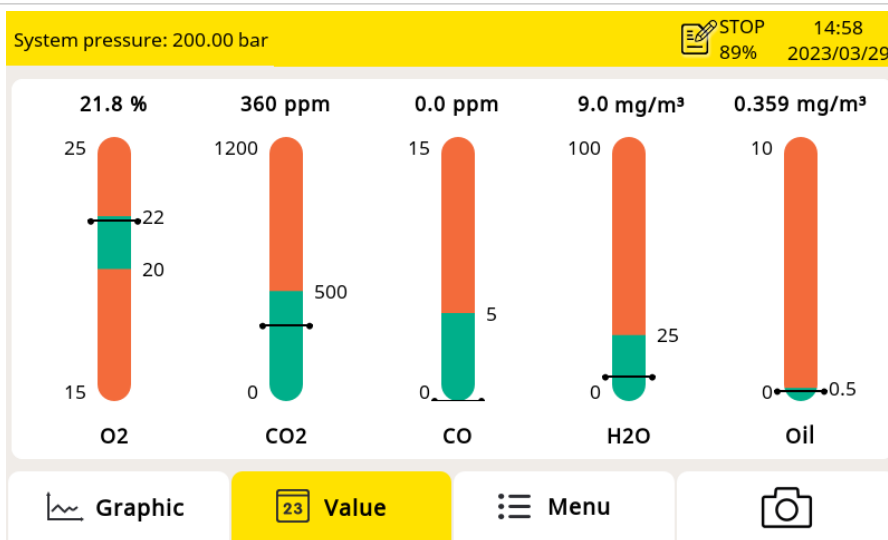

Status bar

Display area

Quick buttons and icons

9.1.1 Quick Buttons and Icons

Graphic Switch to the graphic view of measurement data

Value Switch to the value view of measurement data

Menu Access the operation menus

 Capture screen shots

9.1.2 Icons in the Status Bar

	System errors occur. Press this icon to get further information.		Sensor unit is not matching with configuration.
	Calibration is expired. Please contact the manufacturer or your local dealer.		Alarm triggered
	Low water level indicator		High water level indicator
	S4A remote connected		4G/LTE signal strength
	Type of the connected sensor does not match with the sensor type configured in the device.		
	Data logger status: - STOP—Indicates that the data logger is not running. - LOG—Indicates that the data logger is running.		

9.2 Value Screen

Shows the measured values in real time.

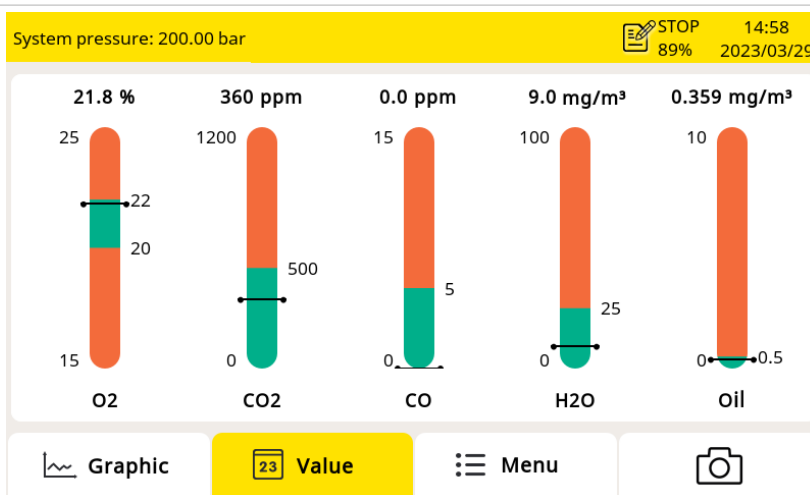

To view the value screen, press **Value** on the bottom bar.



9.3 Graphic Screen

Shows the dynamic graphs of all measurements. Press **Graphic** to view the graphic screen.

The graphic view is pre-configured in the factory. You can view the

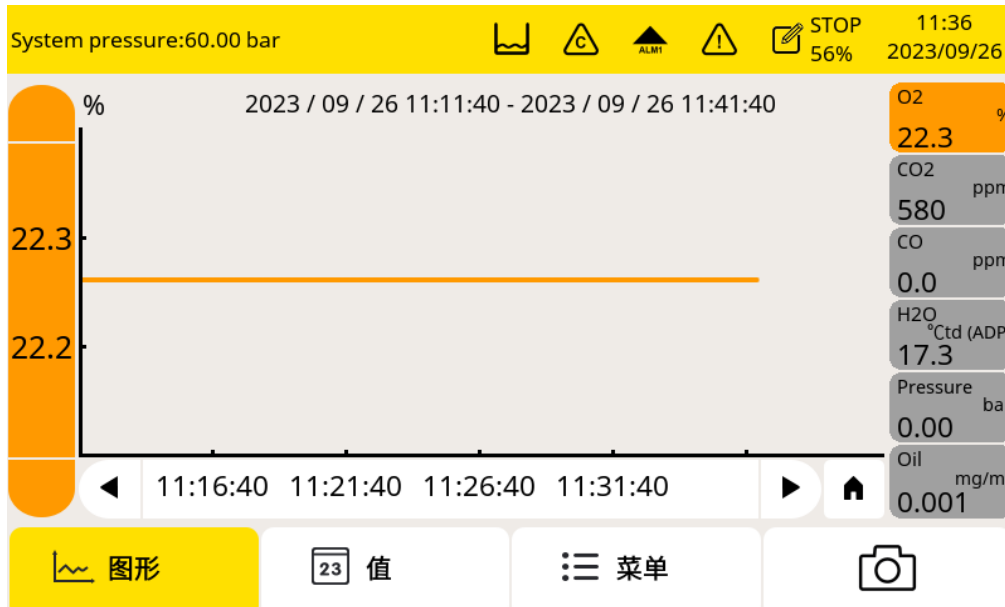
S606 measurement graph directly or configure the graphic freely.



Item	Description
Y-axes	Touch Y-axes to scale it
X-axes	Touch X-axes to define viewing period
	By clicking this icon, can go back to the current time
	To scroll time
Channel data area	- One click can switch the single channel - Long touch is for settings

9.4 Menu

Enables you to change the S606 settings.

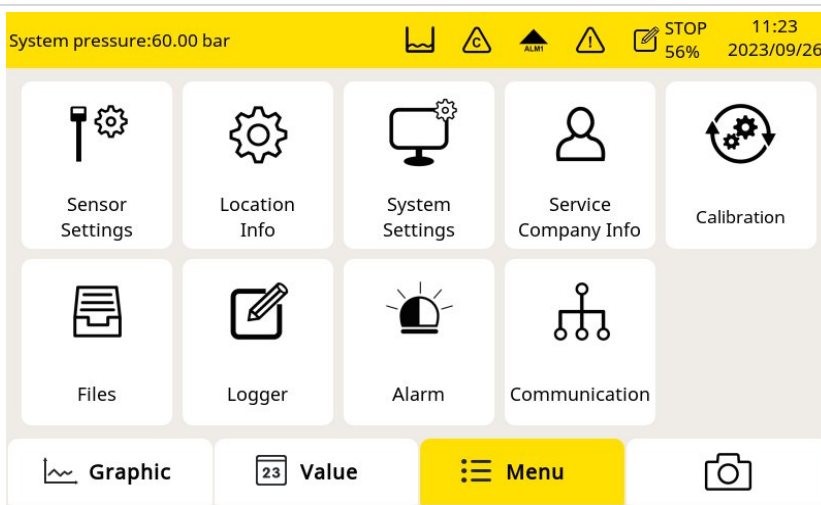

You can enter the main menu by pressing **Menu** in the quick buttons bar at the bottom.

9.4.1 Sensor Settings

You can select the different standards. By selecting the standard, the limit value is automatically set.

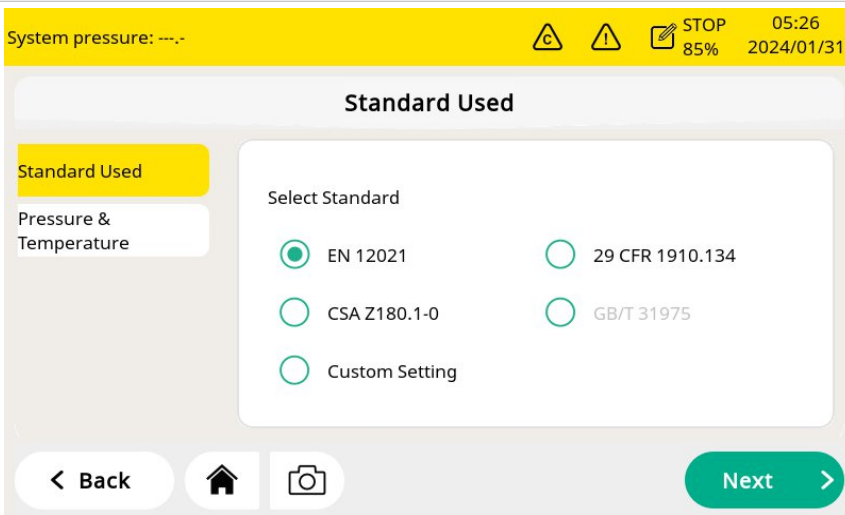

Click the radio button to select the different standard.

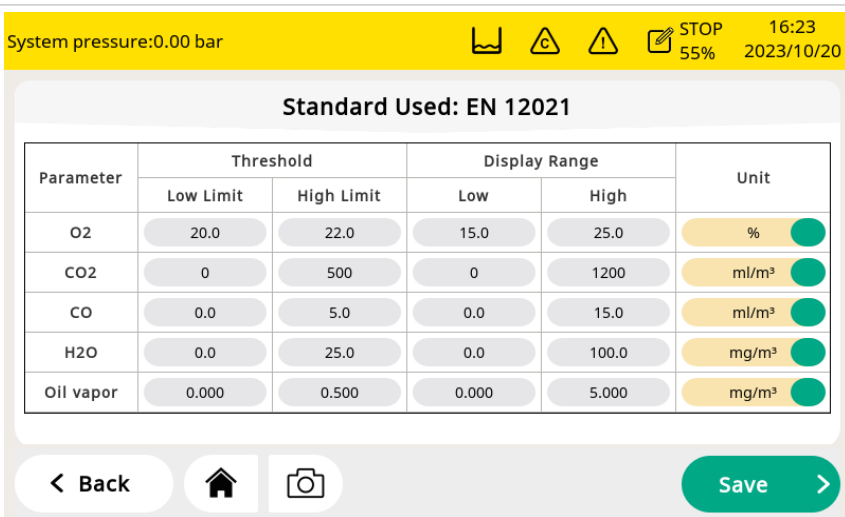

After choosing the standard, you can check the detailed settings. For the custom setting, you can manually change the parameters according to the requirements.

Note: For the standard EN12021, the threshold value for H₂O varies depending on the application. If the user selects this standard, the actual application needs to be selected and the appropriate settings will be done automatically.

9.4.2 System Setting

Enables you to configure general settings of the S606.



Password	To configure a password to protect the S606 from unauthorized operations.
Back light	To adjust the back light brightness and the dimming timeout.
Calibrate touch screen	To calibrate the touch accuracy.
Language	To select the user interface language.
Date time	To configure the date and time.
Device info	<ul style="list-style-type: none"> • To view the device software and hardware information, such as S/N and firmware versions of the system and the sensors. • To know the sensor information.
System Update	To update the system firmware.
Reset	To reboot the display.

9.4.3 Service Company Information

Enables you to add the contacts of the service provider. The company logo can be imported.

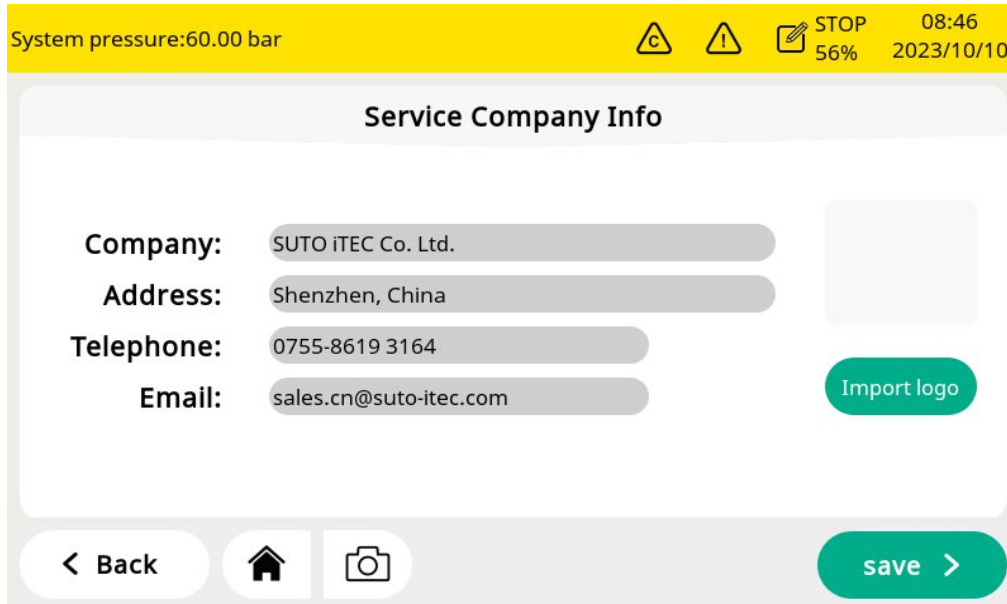

9.4.4 Calibration of Gas Sensors

Calibrate the gas sensors and display general information about the calibration.

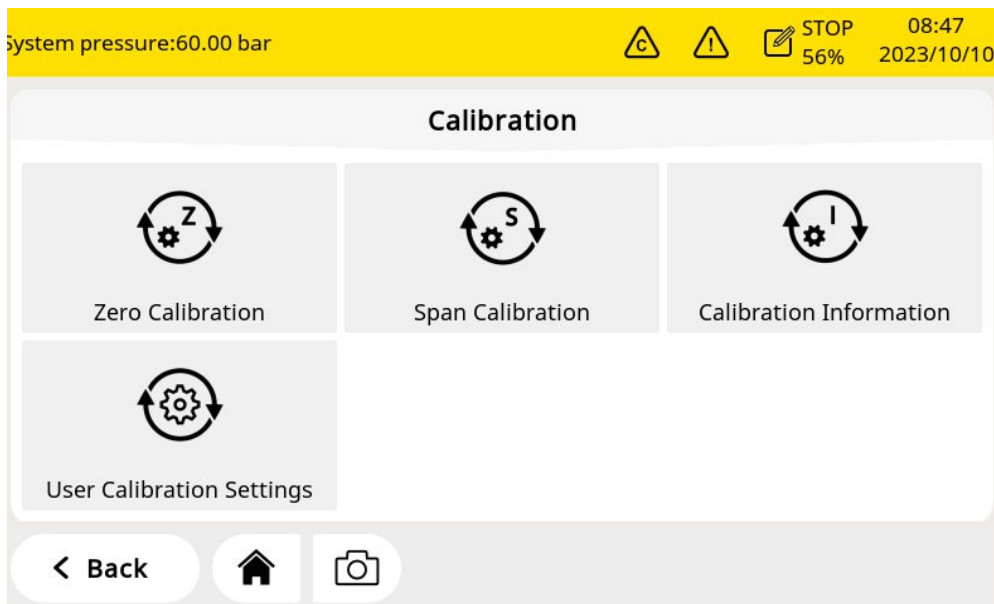

Zero calibration	Do the zero calibration.
Span calibration	Do the span calibration.
Calibration information	Check the sensor calibration information, such as last calibration data, next calibration date etc.
Calibration settings	Set the reference value.

9.4.5 Files

Shows different type files. The recorded files are log files for you to check the recorded measurement data. All calibration and test data are included in the calibration records file.

All alarm information can be checked in the alarm history.

Clicking the camera icon can capture screen-shots. Memory status shows the free and total space at present.

The files and screen-shots can be deleted and exported. The captured screen-shots can be viewed directly on the display.

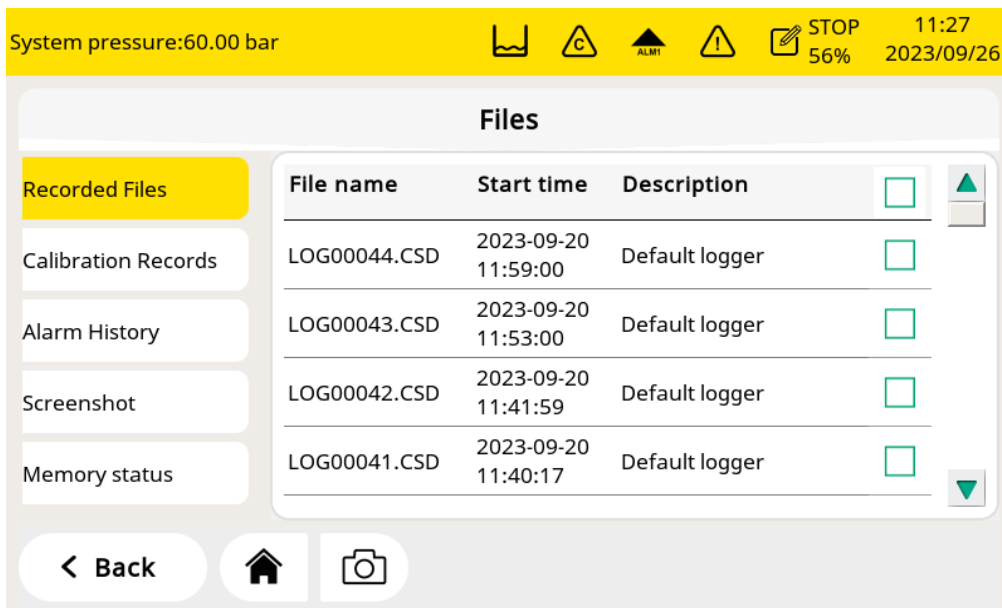

9.4.6 Logger Setting

Enables you to start and stop the logger and view logger status.

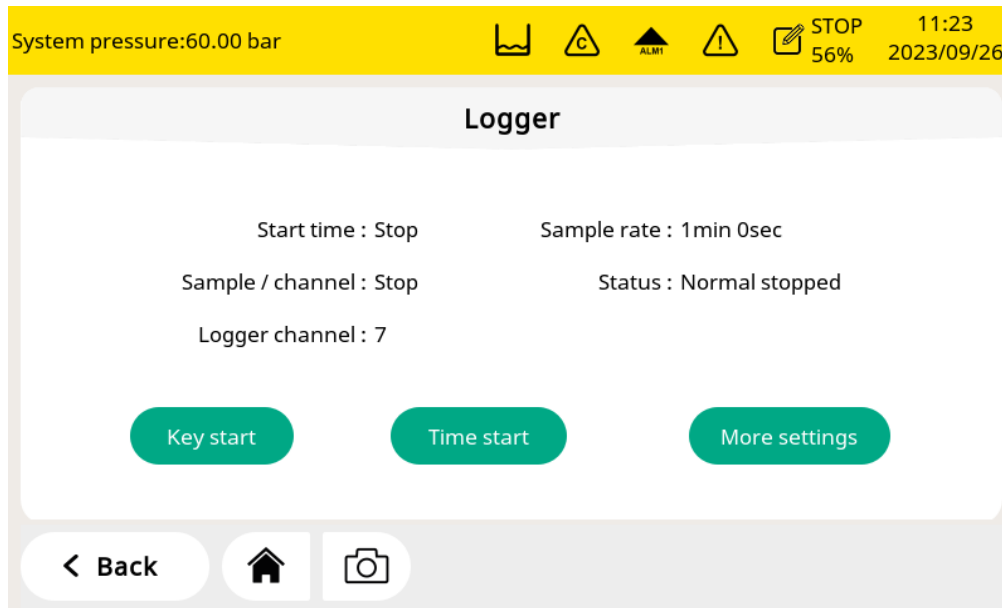

Start time	Shows logger start time.
Sample / Channel	Shows the number of recorded samples per logging channel.
Logger channel	Shows the total number of the recorded channels.
Sample rate	Shows the sampling rate. To change the sampling rate, click More settings .
Status	Shows the logger status.
Key start	Click to start logging immediately.
Time start	Click to configure a scheduled start for logging.
More setting	Click to configure the logging interval, logging mode, and memory mode. <ul style="list-style-type: none"> • Average: Turning Average on means to log the average value during an interval; turn the average off means the logged value is an instantaneous one. • Memory mode: Choose a mode as needed. • Wrap around: If the memory is full, new logging data overwrites the oldest data.

9.4.7 Alarm Setting

You can define alarms for the S606. The S606 offers one internal alarm relay I and an optical alarm indication (flashing value). The relay I indicates the summary alarm by default. The summary alarm is triggered when any of the measured values of O₂, CO₂, CO, dew point, and oil reach their respective alarm thresholds. The relay I is used to output the summary alarm.

An optional relay module is also available. When the relay module is enabled, up to 8 relays can be configured.

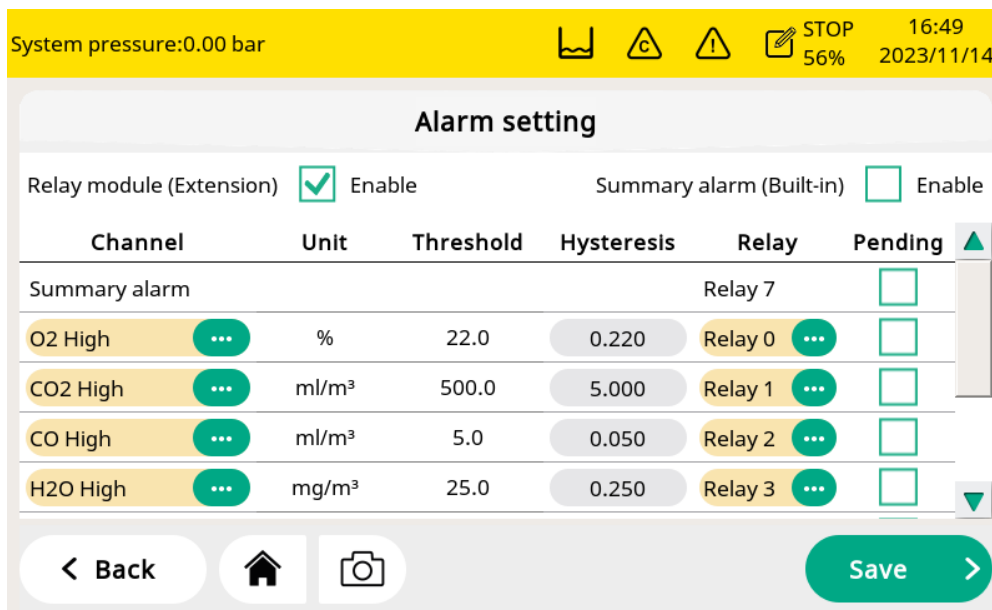

Relay module (Extension)	In this field, you can activate or deactivate the optional 8-channel relay module. If you have installed the relay module, select Enable to activate its function, or select not to disable the function of the optional relay module.
Summary alarm (Built-in)	This relay indicates the summary alarm. The summary alarm is triggered when any of the measured values of O ₂ , CO ₂ , CO, dew point, and oil reach their respective alarm thresholds. Relay I is used to output the summary alarm and is located at the backside of the screen. Select Enable to enable this summary alarm or do not select Enable to disable the summary alarm.
Channel	Select the channel to be configured.
Unit	The unit depends on the sensor setting and is shown automatically after selecting the channel.
Threshold	The threshold depends on the sensor setting and is shown

automatically after selecting the channel.

Hysteresis The alarm is activated when the channel reading reaches the threshold and deactivated when the reading is the threshold minus hysteresis (high alarm) or the threshold plus hysteresis (low alarm).
For example:
Threshold is 30 and hysteresis is 5.
High alarm: The alarm is activated on channel reading ≥ 30 and deactivated on readings < 25 .
Low alarm: The alarm is activated on channel reading ≤ 30 and deactivated on readings > 35 .

Relay Select a relay. The Relay I is equipped by default. In addition, the optional relay module offers 8 additional relays (Ext. Relay 0 to Ext. Relay 7). These 8 relays can only be displayed and used when the optional relay module is installed and enabled.
The Relay 7 was configured to use for the summary alarm by default.

Pending When **Pending** selection box is chosen, the relay will not activate even an alarm is raised. This is typically used for maintenance and calibration to prevent false alarms.

After setting the alarms, you can view the activated alarms or pend some alarms through **Menu > Alarm > Activated alarm**.



ATTENTION!

Before installing the relay module, turn off the S606. After the relay module is installed, power on the S606 again. Otherwise, the normal use of the relay module may be affected.

9.4.8 Communication

Three kinds of communications can be used. Click the desired button to enter the communication configuration.

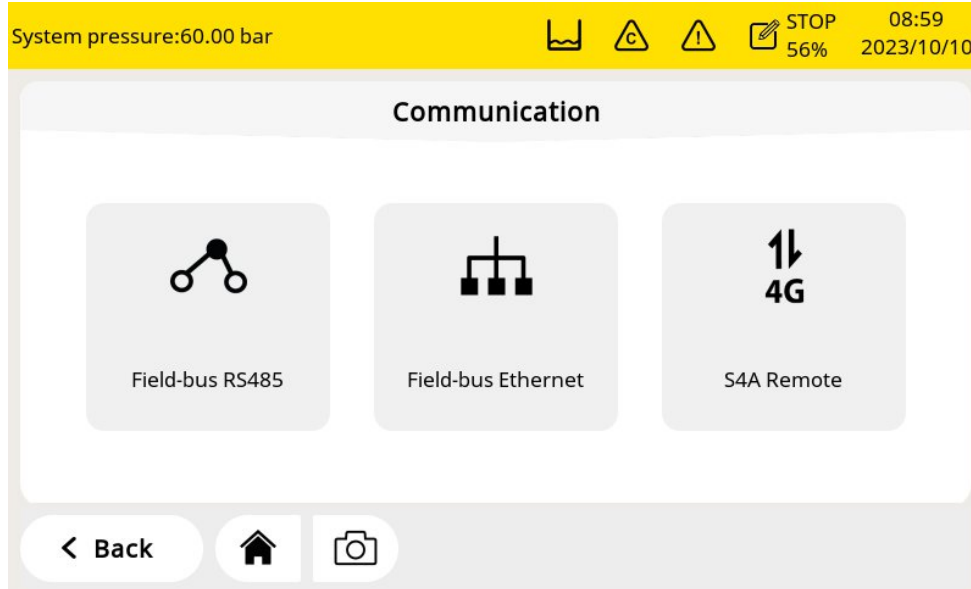

Field-bus RS485	The SUTO protocol and Modbus RTU can be selected according to the requirement. Parameters such as baud rate, address also can be set to make a successful communication.
Field-bus Ethernet	Enter an IP address for the S606 or select DHCP for the S606 to be assigned with a dynamic IP address. You also can read the system information or set some parameters through this communication.
S4A Remote	This communication enables remote access to the S606. A 4G dongle module is required, and click connect , the S4A remote server can be connected.

9.5 Configure S4A Remote Connection

If you buy the 4G/LTE module, you can view online measurement data, and logs on the S4A remotely after establishing the connection between the S606 and the 4G Modem.

Follow steps below to establish the connection.

Do followings on the S606

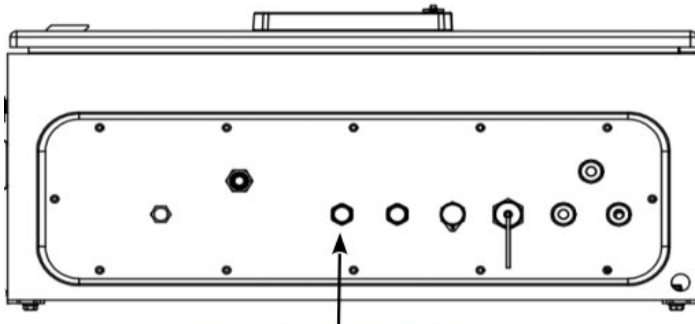

M12 connector for Connecting 4G/LTE Modem

1. Turn off the S606.
2. Insert a SIM card to 4G/LTE Modem.
3. Connect the 4G/LTE Modem through the M12 connector on the S606.
4. Restart the boot power.

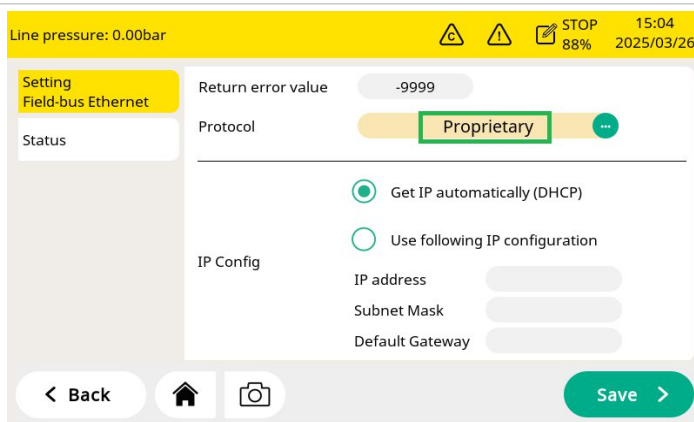

5. Click **Menu > Communication > Field-bus Ethernet > Setting** to select the **Proprietary** protocol.

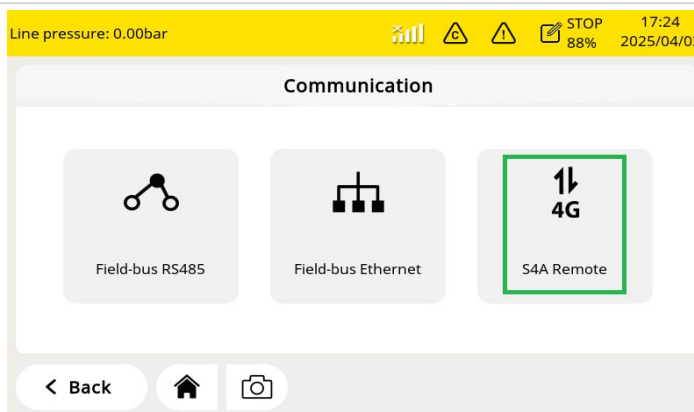

6. Click **Menu > Communication > S4A Remote**.

7. Click **Connect** button.

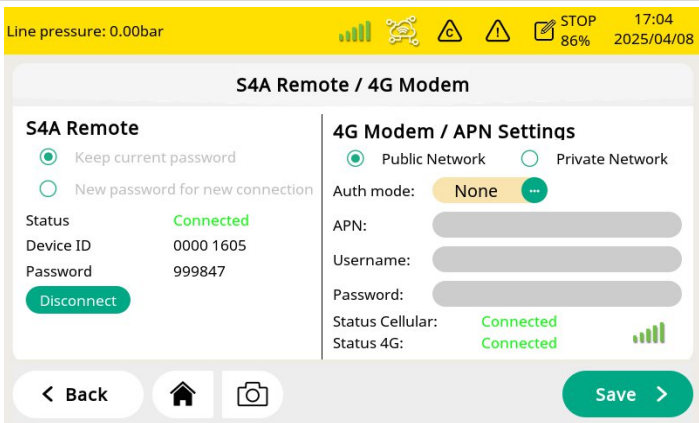
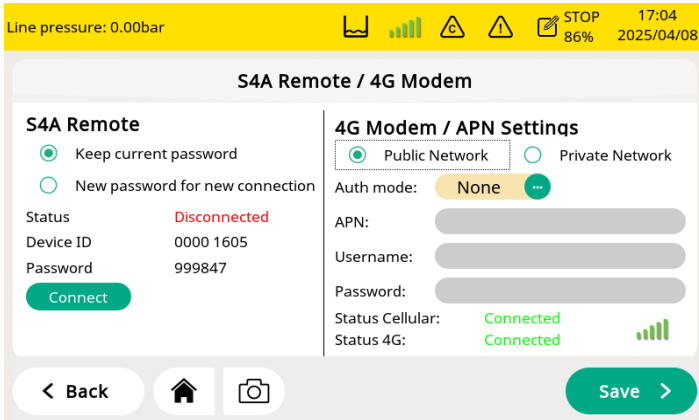

When the connected status is displayed, the remote connection has been established.

Note: Remote communication of the S4A is established only when the 4G module is connected with both the cellular network and the 4G network.

Do followings on the S4A Software

1. Download the S4A Software and install it on your PC.
2. Start the S4A software.

Note: Make sure your firewall does not block the S4A software required to connect to the S606.

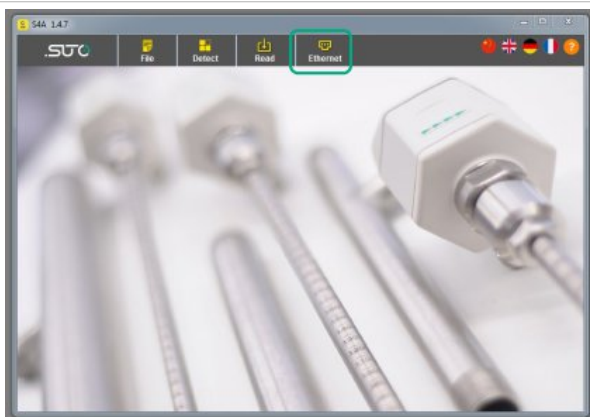

3. Check the connection modes:
 - For USB connection: set it to **USB**.
 - For Ethernet and S4A remote communication: set it to **Ethernet**.

You can change the mode by clicking this mode button.

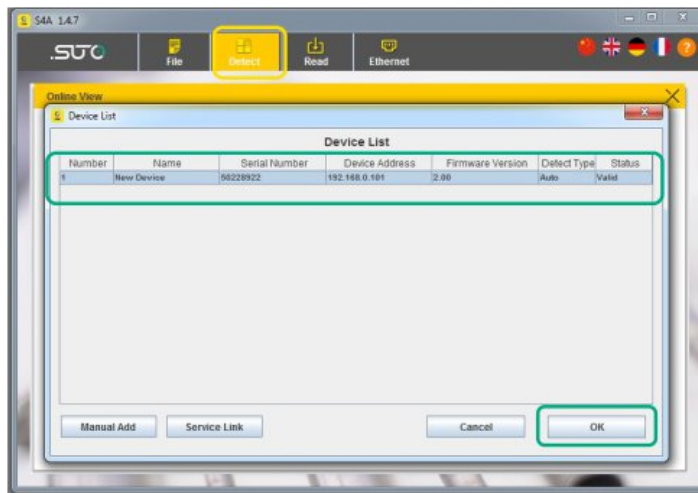

4. Click **Detect** button.
A new pop-up window appears showing the automatically connected S606.
5. Select the S606 by clicking the line and the click **OK**.

Note: If the S606 is not shown, check your connection and make sure that it is reachable.

- For Ethernet connection, you can add the device manually by clicking **Manual Add**.
- You can check the IP address of the S606 via **Menu > Communication > Fieldbus Ethernet > Status**.
- For S4A remote communication, you can add the device manually by **Service link**.
- You can check the Device ID(SN) and password of the S606 via **Menu > Communication > S4A remote**.



6. Live readings from the S606 are displayed.

Now the S4A remote communication has been successfully established, you can view real-time data, export log record files, export reports, and more.

9.6 SIM Card Requirement for 4G/LTE Option

To establish the 4G/LTE communication between S606 and S4A software with S4A remote function, customer needs to buy a SIM card locally.

9.6.1 Data Traffic

Data traffic required is 7 GB/month if the system is running 7×24 hours.

9.6.2 PIN Code Protection

The S606 does not support modifying PIN code on the screen. If your SIM card has PIN code protection, disable it by using other devices, for instance using your mobile phone.

9.7 Export Files via the S4A Software

After establishing the remote connection, you can export various files of the S606 through the S4A software. The files can be log files, screen-shots, historical alarm files, and calibration files.

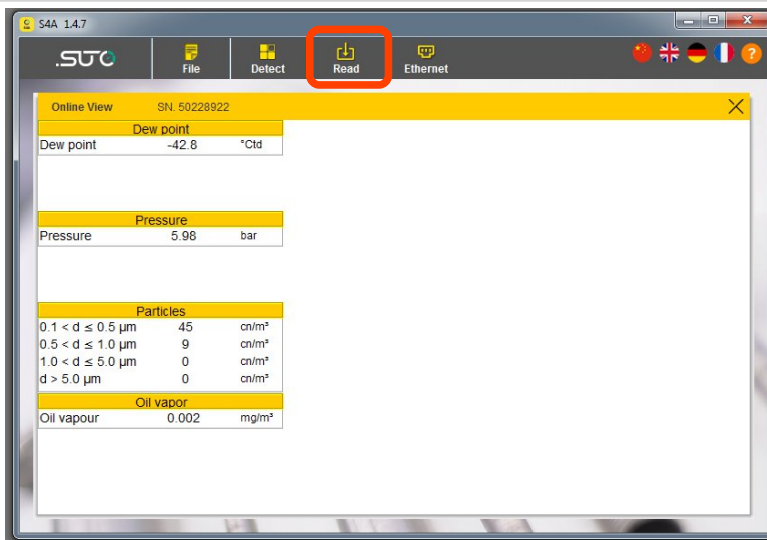

1. On the S4A software, click **Read** on the menu bar.

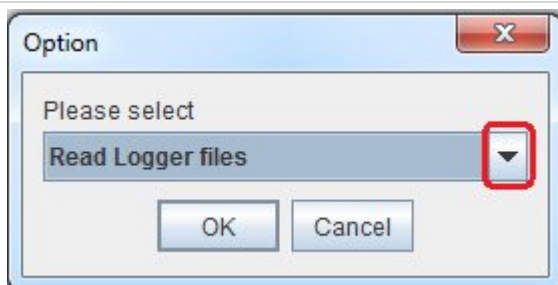

2. A pop-up window appears. You can select files by opening the drop-down menu.
3. Click **OK**.

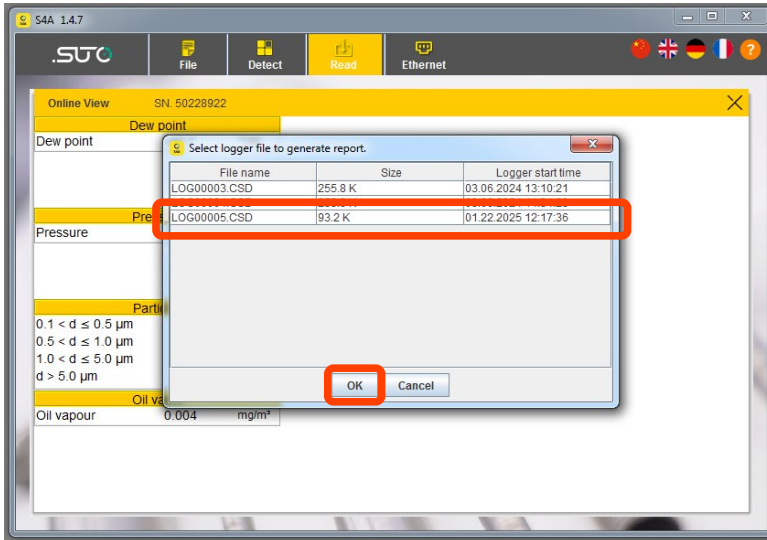

4. A pop-up window shows the files available in the S606 that can be exported.

5. Select the file to be exported and click **OK**.

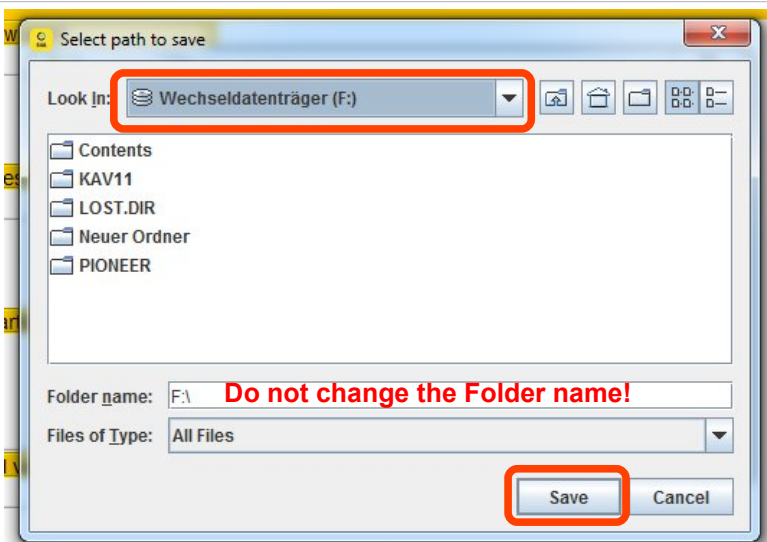

6. Choose a folder where the files will be saved.

Note: Do not change the folder name in the line. Otherwise, the files cannot be exported.

7. Click **Save** to save the file.

Done!

Your files is now saved in the selected folder.

10 Software Installation

Following software can be downloaded from the SUTO website at www.suto-itec.com.

S4A	Free logger readout and data analysis software
S4M	Multiple-device data acquisition and analysis software

After downloading, follow the onscreen instructions to install the software.

11 Firmware Updates

To update the firmware, just need a OTG-USB drive (supplied with the S606) and the firmware file (format like DIS606_1.82.tar)



1. Insert the USB to the connector on the front panel.

Note: Do this after the S606 has fully booted.

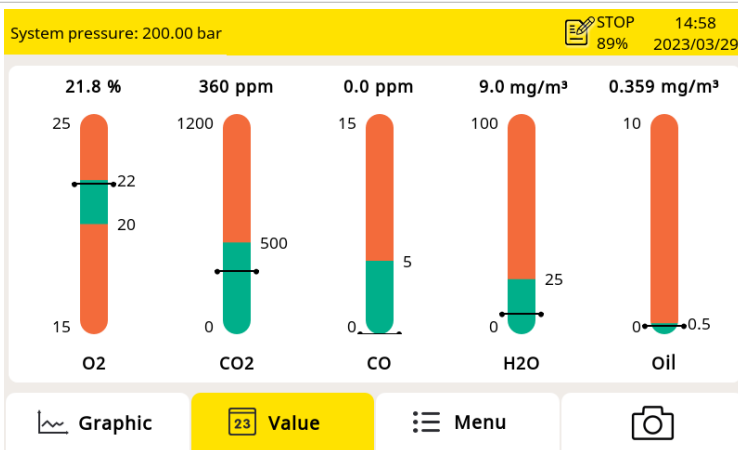

2. Click **Menu** to enter the Menu page.

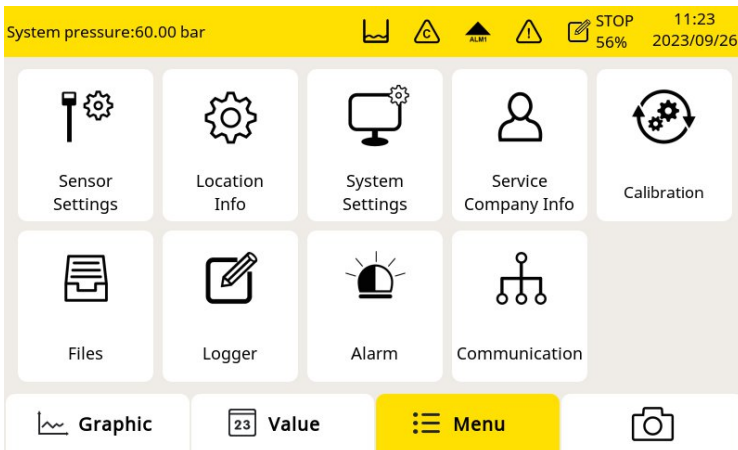

3. Click **System Settings**.

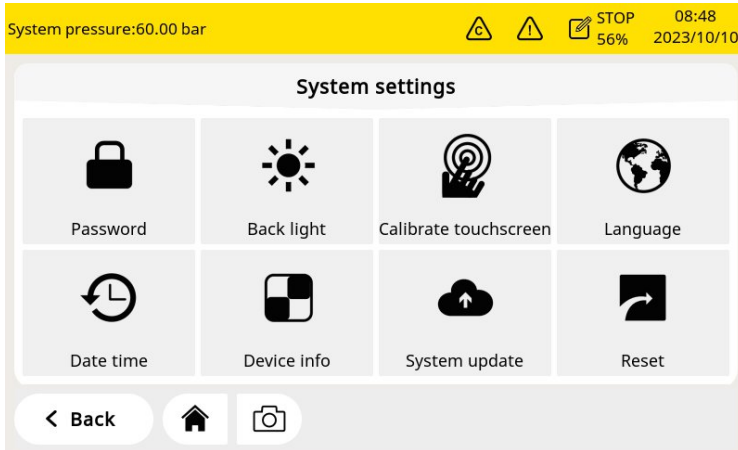

4. Click **System Update**.

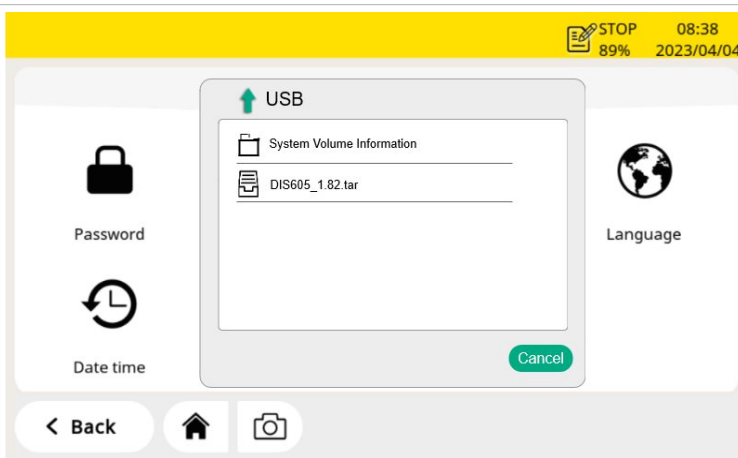

5. A pop up will be shown. Then click the firmware file in this example DIS606_1.82.tar.

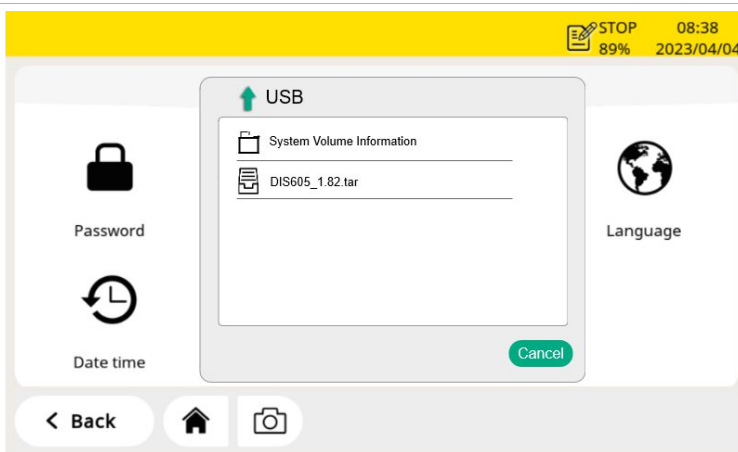

6. A new pop up will ask you to confirm the update. Click **Yes** to start the update. Click **NO** to abort the operation.

When the update is ongoing, note the following:

- Do not turn off the power.
- Do not disconnect the USB.
- Wait until the device is fully booted again before removing the USB.

After the update is done, you may now select the new language or use new functions offered in the update.

12 Calibration

Because the sensor accuracy is affected by the environment conditions, it is recommend to calibrate the device at least once a year. It is also a good engineering practice to test the accuracy of the gas sensors from time to time before measurement and adjust the reading if required. The calibration should be done by trained personnel. You can check calibration information through **Menu > Calibration > Calibration Information**.

Calibration Information				
Sensor	Serial Number	Last Cal.	Next Cal.	Rem.lifetime(days)
O2	20221110	09.11.2022	09.11.2023	
CO2	20221104	21.03.2023	20.03.2024	
CO	20220920	05.12.2022	05.12.2023	239
H2O	12228190	21.03.2023	20.03.2024	
Oil	17223944	28.01.2023	28.01.2024	110
Humidity	47218488	21.03.2023	20.03.2024	

12.1 Calibration for DP Sensor and Oil Sensor

For the dew point sensor and oil sensor, the calibration is complicated and time consuming, so SUTO provides the exchange service, that is, the complete sensor unit is exchanged with a newly-calibrated unit. This saves time and costs.

12.2 Calibration for O₂, CO, CO₂ Sensor

The O₂ sensor, CO sensor, and CO₂ sensor can be calibrated on site or replaced with calibrated sensors using the exchange service of SUTO.



ATTENTION!

Please save all your measurement data on an external device before returning the instrument to calibration and service. It might be necessary to reset the displays storage during calibration and service.

12.2.1 Calibration Gases

Depending on the type of calibration, different calibration gases are used.

Zero gas

The zero gas is a test gas used for zero-point adjustment. The zero gas must be free from the measured gas or other substances that have cross-sensitivity.

Calibration and test gas

The span gas is a calibration gas used for sensitivity adjustment or verification of the calibration result.

Here is recommended gases for the calibration and test:

- Zero gas: 8%...12% O₂, N₂ background
- Calibration gas O₂: 20%...24% O₂, N₂ background
- Calibration gas CO: 16...20 ppm CO, N₂ background
- Calibration gas CO₂: 800...1000 ppm CO₂, N₂ background
- The test gas can be half of the calibrated gas. For example:
 - Test gas CO: 10 ppm CO, N₂ background (the cal gas is 20 ppm CO)
 - Test gas CO₂: 500 ppm CO₂, N₂ background (the cal gas is 1000 ppm CO₂)

Uncertainty of gases is 1% (K=2)



Attention!

Please select the suitable calibration gas, otherwise the sensor measurement accuracy will be affected.

12.2.2 Calibration Procedure

You can enter the calibration through **Menu > Calibration**.

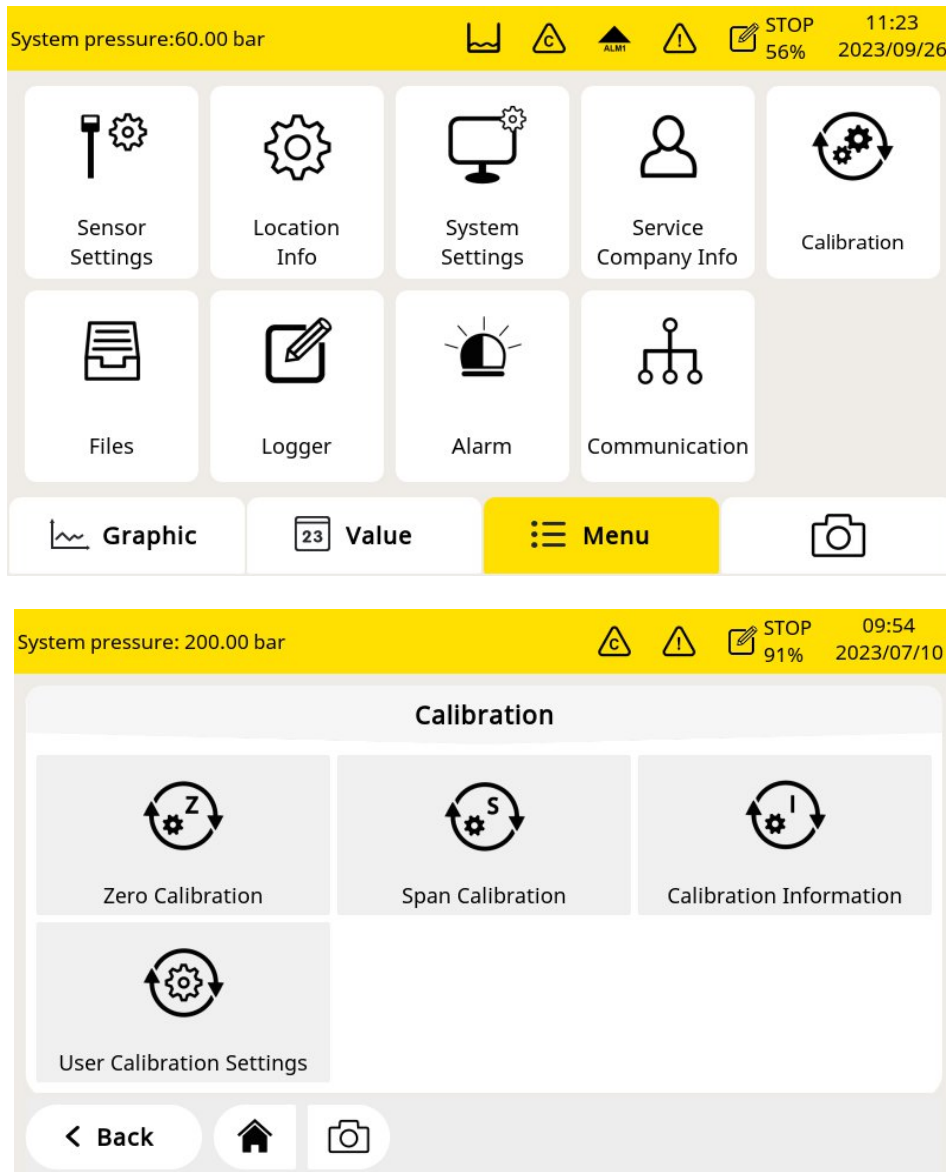

WARNING!

Please do the calibration after the sensor is ready to work, for example the warm-up phase of the sensor is completed.

Do not inhale the calibration gas. It can be harmful to health or even death!

Alarms are triggered by calibration gas. You can disable relays to prevent from triggering external devices.

Calibration Settings

The calibration reference data can be set before the calibration through **Menu > Calibration > User Calibration Settings**.

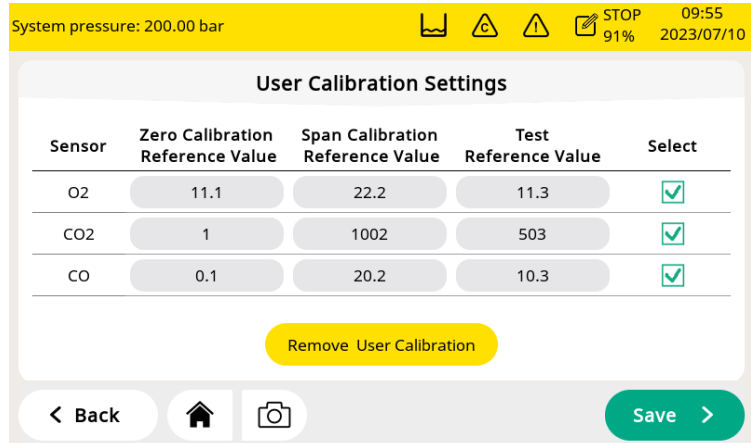

Zero calibration

Enter the zero calibration through **Menu > Calibration > Zero calibration**.

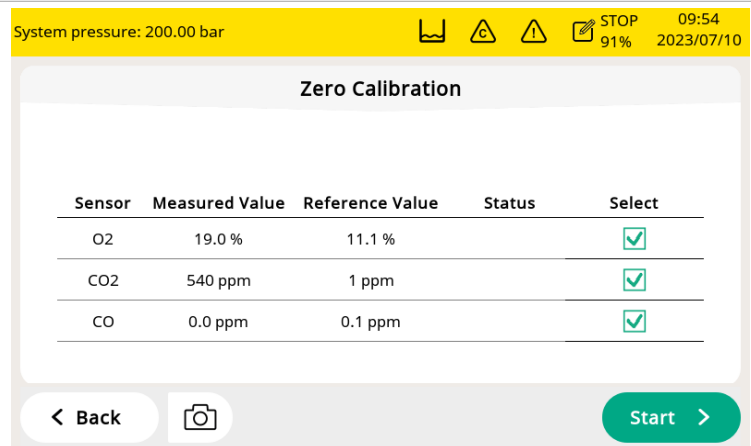

Span calibration

Enter the span calibration through **Menu > Calibration > Span calibration**.

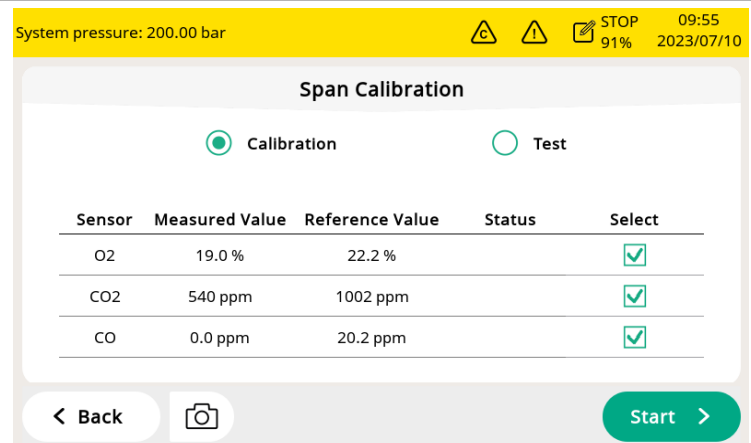

Zero/Span calibration procedures

1. Cut off air supply from the main inlet.
2. Screw off the cap from calibration connector.
3. Connect the calibration hose from the gas cylinder to the calibration connector.
4. Adjust the flow controller at the gas cylinder to 0.5 l/min and the output pressure must 0 bar(g).
5. Select **Menu > Calibration > Zero/Span calibration**.

6. Select the sensor to be calibrated.
7. Supply zero/span gas. Make sure the flow rate of 0.5 l/min.
8. Click **Start**, and a progress bar will show with the calibration remaining time.
9. Zero/Span calibration takes nearly ten minutes. When the calibration is finished, you can check the calibration result in the **Status** field.
10. After the calibration is done, close the gas supply and remove the hose.

After the calibration, you can check the calibration result by using another span gas. Just perform the same steps as above, but select the **test** in the span calibration menu.

Note:

It is recommended to test sensors using the standard gas every 3 months. Please use the above steps to execute the test through **Menu > Calibration > Zero/Span calibration > Test**. If the test result is passed, the sensor does not need to be re-calibrated, if the result is failed, it means that the accuracy of the sensor has been a big deviation, and you need to calibrate the sensor immediately.

Calibration Records

You can view the calibration records through **Menu > Files > Calibration Records**.

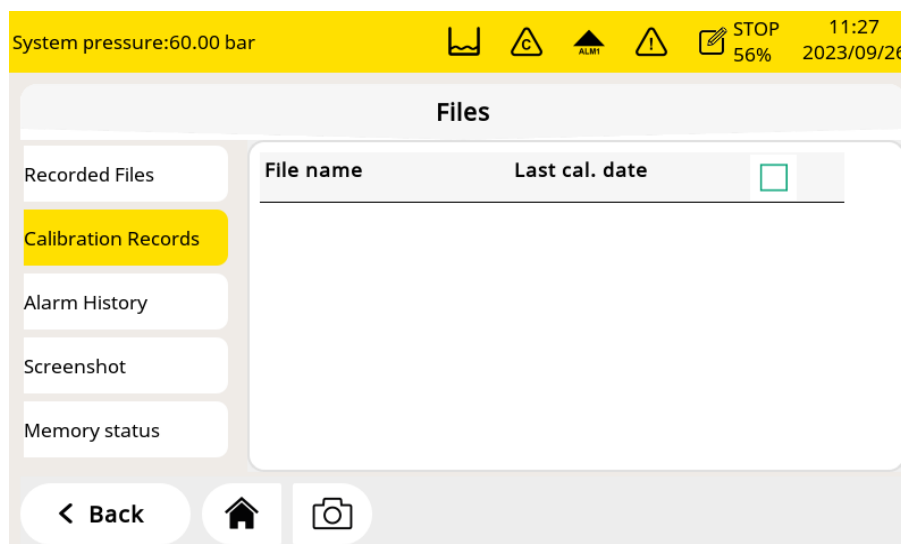



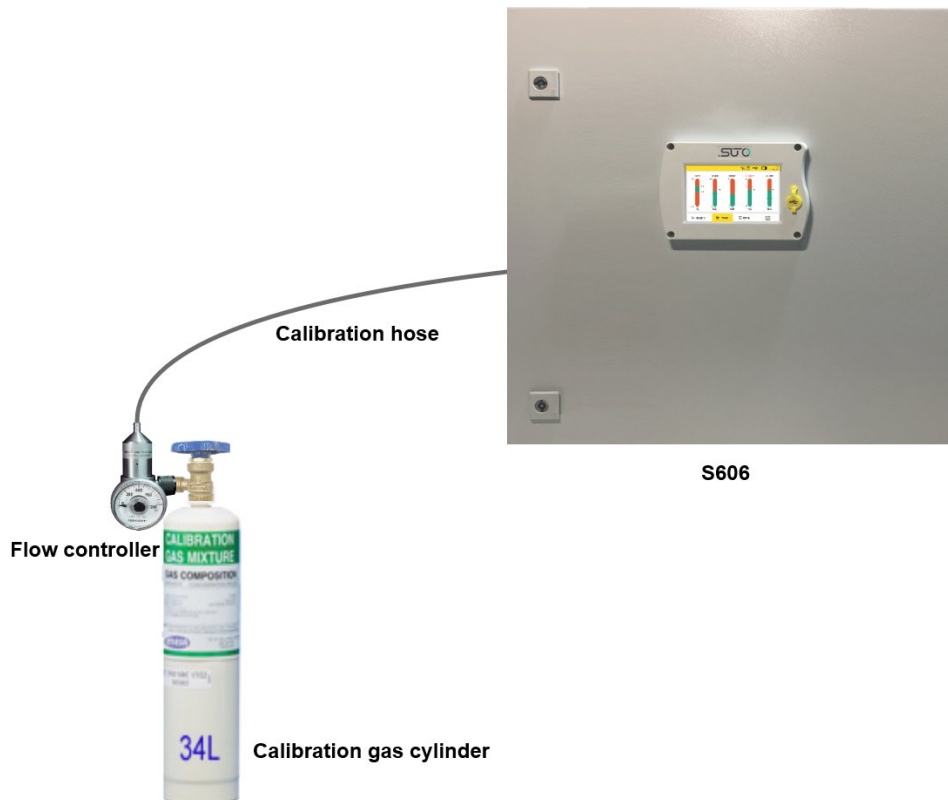

Example for calibration records file:

Calibration / Test Records								
S606 Breathing Air Quality Analyzer								
Item	Cal/Test	Sensor	Date	Reference value	Unit	Measured value Before calibration	Measured value After calibration	Status
1,	Cal,	O2 sensor,	2023.05.31,	11.0,	%	17.3,	17.3,	Failed
2,	Cal,	CO2 sensor,	2023.05.31,	500	ppm	1035,	1035,	Failed
3,	Cal,	CO sensor,	2023.05.31,	0.0,	ppm	0.0,	0.0,	Passed
4,	Cal,	O2 sensor,	2025.05.29,	11.0,	%	17.4,	17.4,	Failed
5,	Cal,	CO2 sensor,	2025.05.29,	0,	ppm	1020,	1026,	Failed
6,	Cal,	CO sensor,	2025.05.29,	0.0,	ppm	0.0,	0.0,	Passed
7,	<u>Kal,</u>	O2-Sensor,	2025.05.29,	11.0,	%	17.4,	17.4,	<u>Nicht</u>
8,	<u>Kal,</u>	CO2-Sensor,	2025.05.29,	0,	ppm	1020,	1030,	<u>Nicht</u>
9,	<u>Kal,</u>	CO-Sensor,	2025.05.29,	0.0,	ppm	0.0,	0.0,	<u>Bestanden</u>
10,	Cal,	O2 sensor,	2025.05.29,	11.0,	%	17.4,	17.4,	Failed
11,	Cal,	CO2 sensor,	2025.05.29,	500	ppm	1035,	1035,	Failed
12,	Cal,	CO sensor,	2025.05.29,	0.0,	ppm	0.0,	0.0,	Passed
7,	Cal,	O2 sensor,	2023.05.31,	11.0,	%	17.3,	17.3,	Failed
8,	Cal,	CO2 sensor,	2023.05.31,	500	ppm	1035,	1035,	Failed
9,	Cal,	CO sensor,	2023.05.31,	0.0,	ppm	0.0,	0.0,	Passed

The figure below is an example for the gas connection.



Here is the recommended supplier and accessories list:

Item	Brand	Description	Picture
Flow controller	MESA	Series 400 Fixed Flow Regulator ID:400-LPM	
Calibration Gas	MESA	Zero gas O ₂ : 11% O ₂ , N ₂ background O ₂ : 22% O ₂ , N ₂ background CO: 20 ppm CO, N ₂ background CO ₂ : 1000 ppm CO ₂ , N ₂ background 34L, steel calibration gas cylinders	
Test Gas	MESA	CO: 10 ppm CO, N ₂ background CO ₂ : 500 ppm CO ₂ , N ₂ background 34L, steel calibration gas cylinders	
Transport casing	MESA	Carrying cases ID:500	
Website: https://mesagas.com/			

13 Optional Accessories

To buy the following optional accessories, contact the manufacturer or your local dealer.

- Teflon hoses
- Sorts of adapters
- Relay module (P/N: A1510)
- USB 4G dongle, including S4A software (P/N: A1670)
- 4G USB Dongle protection case, with extension cable 2 m and M12 Connector (P/N A554 0131)
- Pressure reducer, including the transportation case (P/N: A604 0004)

14 Maintenance

The S606 must be serviced on a regular basis. It is recommended to do the following:

- Check the humidifier condition (See section 7.5.1).
- Test the sensor (See section 12.2.2).

Use a moist fabric to clean the device. For the use in GMP-area, it is possible to disinfect through wipe disinfection. For this please contact the manufacturer or your local dealer.



ATTENTION!

Please dry the device after cleaning using a clean and dry fabric. Always take care, that the fabric for cleaning is not too wet because water could get into the device and cause damage.

15 Disposal of Waste



Electronic devices are recyclable material and do not belong in the household waste.

The sensor, the accessories and its packing must be disposed according to your local statutory requirements. The dispose can also be carried by the manufacturer of the product, for this please contact the manufacturer.

16 Warranty

Please find the warranty as a separated warranty card included with the instrument delivery.

The warranty does not cover any wear parts or consumables, therefore the UV lamp with limited lifetime as well as the internal filter are not covered by the warranty.

17 Appendix - Modbus Holding Register Table

17.1 Modbus Interface

The default settings of the Modbus interface are as follows:

Communication parameters (Modbus/RTU)

Baud rate	: 19200
Device address	: Last two digits of the serial number
Framing / parity / stop bit	: 8, N, 1
Response time	: 1 second
Response delay	: 0 ms
Inter-frame spacing	: 7 char

Communication parameters (Modbus/TCP)

DHCP	: Yes
MAC	: Set ex-factory
IP address	: Dynamic or Static
Subnet	: Dynamic or Static
Gateway	: Dynamic or Static
Timeout	: \geq 200 ms

Response message that the device returns to the master:

- Function code: 03

The information of the byte order is shown in the table below:

Byte Order	Sequence				Data Type
	1st	2nd	3rd	4th	
1-0-3-2	Byte 1 (MMMMMMMM*)	Byte 0 (MMMMMMMM *)	Byte 3 (SEEEEEEE)	Byte 2 (EMMMMMMM*)	FLOAT
1-0-3-2	Byte 1	Byte 0 LSB	Byte 3 MSB	Byte 2	UINT32 INT32
1-0	Byte 1 MSB	Byte 0 LSB	---	---	UINT16 INT16
1-0	Byte 1 XXX *	Byte 0 DATA	---	---	UINT8 INT8

* S: Sign, E: Exponent, M: Mantissa, XXX: no value

Explanations of MSB and LSB

MSB MSB refers to Most Significant Byte first, which follows the Big-Endian byte order.

For example, if the main system follows the MSB first order:

When the 4-byte floating number, in the order of Byte1-Byte0-Byte3-Byte2, is received from the slave (sensor), the master must change the byte order to Byte3-Byte2-Byte1-Byte0 for the correct display of the value.

LSB LSB refers to Least Significant Byte first, which follows the Little-Endian byte order.

For example, if the main system follows the LSB first order:

When the 4-byte floating number, in the order of Byte1-Byte0-Byte3-Byte2, is received from the slave (sensor), the master must change the byte order to Byte0-Byte1-Byte2-Byte3 for the correct display of the value.

17.2 Modbus Register Table

The following table lists specifications of the Modbus output channels in this device.

Holding register	Data type	Data Length	Channel Description	R/W	Remark
Common System Information					
2000	INT16U	2-Byte	Group ID (=6)	R	Gas flow sensor, water flow etc.
2001	INT16U	2-Byte	Device ID	R	Unique identification
2002	INT32U	4-Byte	Serial number	R	Factory S/N
2004	INT16U	2-Byte	High = 0xFF, Low byte HW version	R	Before it was SW version in High Byte, but in future there will be a 3 BYTE version and the High Byte is set to 0xFF
2005	DOUBLE	8-Byte	Calibration date	R	Date time (8-bytes) format is time-variant (Microsoft)
2009	INT16U	2-Byte	Valid days from calibration date	R	
2010	INT16U	2-Byte	Number of Measuring Channels	R	1 ... 96
2011	STRING	16-Byte	Device description	R/W	"S605" etc.
2019	INT16U	2-Byte	Version of Modbus Definition	R	0x0201 = 02.01
2020	INT16U	2-Byte	Version of this register table	R	Start from 0x100 = 1.00
2021	INT32U	4-Byte	Calibration date	R	unix time format
2023	INT32U	4-Byte	Production date	R	unix time format
2025	INT32U	4-Byte	FW version (low 3 Bytes used)	R	New firmware version format: XX.XX.XX
2027	STRING	16-Byte	Device Location	R/W	User can enter a text
2035	STRING	16-Byte	Measurement Point	R/W	User can enter a text
2043	INT16U	2-Byte	Number of sensors	R	How many and which SUTO sensors are connected to the main unit. Their settings are found from 10000 up.
Modbus/RTU Settings					
2100	INT16U	2-BYTE	Write Password	W	Response: 0 → access permitted 1 → authorization required password: 0XA5A5
2110	INT16U	2-Byte	Modbus baud rate index	R/W	

			0---1200 1---2400 2---4800 3---9600 4---19200 5---38400 6---57600 7---115200		
2111	INT16U	2-Byte	Modbus parity	R/W	
2112	INT16U	2-Byte	Modbus stop bit	R/W	
2113	INT16U	2-Byte	Device Address	R/W	
Modbus/TCP Settings					
2120	INT32U	4-Byte	Static IP address	R/W	
2122	INT16U	2-Byte	Portal number	R/W	
2123	INT32U	4-Byte	Subnet mask	R/W	
2125	INT16U	2-Byte	DHCP enabled	R/W	
2126	INT32U	4-Byte	IP address	R	For DHCP only
Alarm Settings					
2130	FLOAT	4-Byte	O2 High alarm threshold	R	
2132	FLOAT	4-Byte	O2 Low alarm threshold	R	
2134	FLOAT	4-Byte	O2 High Hysteresis	R	
2136	FLOAT	4-Byte	O2 Low Hysteresis	R	
2138	INT16U	2-Byte	Relay port/status	R	bit7-bit0 (low byte): 0x00= relay 0 ... 0x07 = relay 7 relay 0-7 are on the optional relay module bit15: 0= channel alarm relay close 1= channel alarm relay open bit 14: 0 = summary relay close 1 = summary relay open
2139	FLOAT	4-Byte	CO2 High alarm threshold	R	
2143	FLOAT	4-Byte	CO2 Hysteresis	R	
2147	INT16U	2-Byte	Relay port/status	R	See explanation at 2138
2148	FLOAT	4-Byte	CO High alarm threshold	R	
2152	FLOAT	4-Byte	CO Hysteresis	R	
2156	INT16U	2-Byte	Relay port/status	R	See explanation at 2138

2157	FLOAT	4-Byte	H2O High alarm threshold	R	This is the dew point measurement.
2161	FLOAT	4-Byte	H2O Hysteresis	R	
2165	INT16U	2-Byte	Relay port/status	R	See explanation at 2138
2166	FLOAT	4-Byte	Oil High alarm threshold	R	
2170	FLOAT	4-Byte	Oil Hysteresis	R	
2174	INT16U	2-Byte	Relay port/status	R	See explanation at 2138
2175	FLOAT	4-Byte	Pressure High alarm threshold	R	
2177	FLOAT	4-Byte	Pressure Low alarm threshold	R	
2179	FLOAT	4-Byte	Pressure High Hysteresis	R	
2181	FLOAT	4-Byte	Pressure Low Hysteresis	R	
2183	INT16U	2-Byte	Relay port/status	R	See explanation at 2138
2184	FLOAT	4-Byte	Temperature High alarm threshold	R	
2186	FLOAT	4-Byte	Temperature Low alarm threshold	R	
2188	FLOAT	4-Byte	Temperature High Hysteresis	R	
2190	FLOAT	4-Byte	Temperature Low Hysteresis	R	
2192	INT16U	2-Byte	Relay port/status	R	See explanation at 2138
Measurement Channel Information					
2200	INT16U	2-Byte	O2: unit+resolution+type	R	These are the fix information that doesn't need to be read frequently.
2201	INT16U	2-Byte	CO2: unit+resolution+type	R	
2202	INT16U	2-Byte	CO: unit+resolution+type	R	
2203	INT16U	2-Byte	H2O: unit+resolution+type	R	
2204	INT16U	2-Byte	Oil: unit+resolution+type	R	
2205	INT16U	2-Byte	Pressure: unit+resolution+type	R	
2206	INT16U	2-Byte	Temperature: unit+resolution+type	R	
2207	INT16U	2-Byte	Humidity Gas Sensor: unit+resolution+type	R	
Measurement Channel Status and Values					
2301	FLOAT	4-Byte	Channel Value O2	R	Status information, with 2 bits: 00 all OK 01 Out of range 10 Sensor broken 11 Other error
2303	FLOAT	4-Byte	Channel Value CO2	R	
2305	FLOAT	4-Byte	Channel Value CO	R	
2307	FLOAT	4-Byte	Channel Value H2O	R	
2309	FLOAT	4-Byte	Channel Value Oil	R	
2311	FLOAT	4-Byte	Channel Value Pressure	R	

2313	FLOAT	4-Byte	Channel Value Temperature	R	
2315	FLOAT	4-Byte	Channel Value Humidity Gas	R	
Device specific System Information for S605/606					
2600	INT32U	4-Byte	General System status	R	Bit1 bit0(water level): 00: normal 01: low level indicator 10: high level indicator 11: N/A Bit 2: O2 Bit 3: CO2 Bit 4: CO Bit 5: H2O Bit 6: Oil Bit 7: Pressure Bit 8: temperature Bit 9: Humidity for Gas. 0: normal 1: calibration overdue.
2602	INT32U	4-Byte	Alarm status 1: Bit 0-1: O2 Bit 2-3: CO2 Bit 4-5: CO Bit 6-7: H2O Bit 8-9: Oil Bit 10-11:Pressure Bit 12-13: Temp. Bit 14-15: Humidity Gas Bit 16-32: reserved for future	R	2 bits for alarm status: 00: no alarm 01: High alarm 10: Low alarm 11: N/A In Total 16 alarm status
2604	FLOAT	4-Byte	Total work time	R	The total operating time since delivery
2606	FLOAT	4-Byte	Minimum value O2	R	Only can be reset with default setting.
2608	FLOAT	4-Byte	Maximum value O2	R	
2610	FLOAT	4-Byte	Minimum value CO2	R	
2612	FLOAT	4-Byte	Maximum value CO2	R	
2614	FLOAT	4-Byte	Minimum value CO	R	
2616	FLOAT	4-Byte	Maximum value CO	R	
2618	FLOAT	4-Byte	Minimum value H2O	R	
2620	FLOAT	4-Byte	Maximum value H2O	R	
2622	FLOAT	4-Byte	Minimum value Oil	R	
2624	FLOAT	4-Byte	Maximum value Oil	R	
2626	FLOAT	4-Byte	Minimum value pressure	R	
2628	FLOAT	4-Byte	Maximum value pressure	R	
2630	FLOAT	4-Byte	Minimum value temperature	R	
2632	FLOAT	4-Byte	Maximum value temperature	R	

2633	FLOAT	4-Byte	Minimum value humidity gas	R	
2635	FLOAT	4-Byte	Maximum value humidity gas	R	
2637	FLOAT	4-Byte	Minimum value barometer	R	
2639	FLOAT	4-Byte	Maximum value barometer	R	

Note: For any settings (write operation) the password needs to be entered into address 2100 at first. After restart all write operations are disabled by default.

17.3 Unit and Resolution

The first byte is for unit.

Bit7	Bit6	Bit5	Bit4	Bit3	Bit2	Bit1	Bit0
Data type: UINT32				Unit: 1 °C 2 °F 7 mg/m ³ 36 MPa 38 bar 39 psi 109 % 110 ppm 149 °C Td (PDP) 150 °C Td (ADP) 151 ml/m ³ 152 °F Td (PDP) 153 °F Td (ADP)			

The second byte is for resolution.

Bit7	Bit6	Bit5	Bit4	Bit3	Bit2	Bit1	Bit0
Data type:				Resolution:			
0 FLOAT				0 0			
1 UINT32				1 0.0			
2 DOUBLE				2 0.00			
3: UINT16 [0 to 65535]				3 0.000			
4: INT16 [-32768 to 32767]				4 0.0000			
5: INT32 [-2147483648 to 2147483647]							
6: INT64 [-9223372036854775808 to 9223372036854775807]							

SUTO iTEC GmbH

Grißheimer Weg 21
D-79423 Heitersheim
Germany

Tel: +49 (0) 7634 50488 00
Email: sales@suto-itec.com
Website: www.suto-itec.com

SUTO iTEC (ASIA) Co., Ltd.

Room 10, 6/F, Block B, Cambridge Plaza
188 San Wan Road, Sheung Shui, N.T.
Hong Kong

Tel: +852 2328 9782
Email: sales.asia@suto-itec.com
Website: www.suto-itec.com

SUTO iTEC Inc.

5460 33rd St SE
Grand Rapids, MI 49512
USA

Tel: +1 (616) 800-7886
Email: sales.us@suto-itec.com
Website: www.suto-itec.com

SUTO iTEC (Thailand) Co., Ltd.

Head Office: 91/66 Suwinthawong Rd,
Minburi Bangkok 10510
Thailand

Tel: +66 (0)2108 9658
Email: sales.th@suto-itec.com
Website: www.suto-itec.com