

Instruction and Operation Manual

S120

Oil Vapor Monitor



Dear Customer,

Thank you for choosing our product.

Before you start up the device, please read this manual in full and carefully observe instructions stated. The manufacturer cannot be held liable for any damage that occurs as a result of non-observance or non-compliance with this manual.

Should the device be tampered with in any manner other than a procedure that is described and specified in the manual, the warranty is void and the manufacturer is exempt from liability.

The device is designed exclusively for the described application.

SUTO offers no guarantee for the suitability for any other purpose. SUTO is also not liable for consequential damage resulting from the delivery, capability or use of this device.

Revision: 2026-1



Last modifications: April, 2026

Table of Contents

1	Safety instructions.....	5
2	Registered trademarks.....	7
3	Application.....	8
4	Features.....	8
5	Technical data.....	9
5.1	Measuring parameter.....	9
5.2	General data.....	9
5.3	Electrical data.....	10
5.4	Output signals.....	10
5.5	Minimum measurement time.....	10
6	Dimensional drawing.....	11
7	Installation	12
7.1	Installation requirements.....	12
7.2	Wall mounting instructions	12
7.3	Installation procedure.....	14
7.3.1	Installation requirements.....	14
7.3.2	Installation steps.....	15
7.4	Electrical connection.....	16
7.4.1	USB port.....	16
7.4.2	RJ-45 connector.....	16
7.4.3	M12 connectors.....	16
8	Configuration	19
8.1	Integrated display.....	19
8.2	External display device	19
8.3	Service kit.....	19
9	Operations using the integrated display.....	20
9.1	User interface	20
9.1.1	Main screen.....	20
9.1.2	Quick buttons.....	21
9.1.3	Status bar.....	21
9.2	Main menus.....	22
9.3	Sensor settings	23
9.3.1	Basic setting.....	23
9.3.2	Analog output	24
9.3.3	Alarm settings.....	24
9.3.4	Status.....	25
9.4	Guided measurement with PDF report generation.....	25
9.5	Files.....	26
9.6	Service info	26
9.7	System settings	27
9.8	Communication	28

9.8.1 Modbus/RTU settings.....	28
9.8.2 Modbus/TCP settings.....	29
10 Guided measurement.....	30
10.1 Steps for guided measurement.....	31
10.2 Report for guided measurements.....	34
11 Troubleshooting.....	35
11.1 LED indicators.....	35
11.2 Errors and actions.....	36
12 Signal outputs.....	39
12.1 Analog output	39
12.2 Modbus interface	39
12.3 Alarm output	42
13 Optional accessories.....	43
13.1 Sensor display.....	43
13.2 Service kit	43
14 Calibration.....	43
15 Maintenance.....	44
16 Disposal of waste.....	44
17 Warranty.....	44

1 Safety instructions

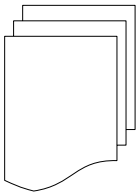

Please check if this instruction manual matches the product type.

Please observe all notes and instructions indicated in this manual. It contains essential information which must be observed before and during installation, operation and maintenance. Therefore this instruction manual must be read carefully by the technician as well as by the responsible users and qualified personnel.

This instruction manual must be available at the operation site of the oil vapor sensor at any time. In case of any obscurities or questions, regarding this manual or the product, please contact the manufacturer.

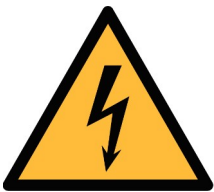

WARNING!

Compressed air!

Any contact with quickly escaping air or bursting parts of the compressed air system can lead to serious injuries or even death!

- Do not exceed the maximum permitted pressure range (see sensors label).
- Only use pressure tight installation material.
- Avoid that persons get hit by escaping air or bursting parts of the instrument.
- The system must be pressure-less during maintenance work.

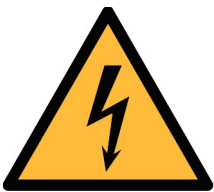

WARNING!

Voltage used for supply!

Any contact with energized parts of the product, may lead to an electrical shock which can lead to serious injuries or even death!

- Consider all regulations for electrical installations.
- The system must be disconnected from any power supply during maintenance work.
- Any electrical work on the system is only allowed by authorized qualified personnel.

**ATTENTION!****Permitted operating parameters!**

Observe the permitted operating parameters, any operation exceeding this parameters can lead to malfunctions and may lead to damage on the instrument or the system.

- The instrument must be operated within or better than compressed air quality Class 4.5.4 according to the ISO8573-1. If the air quality cannot reach the specified Class, the device may show wrong measurement values or even may get damaged.
- Do not exceed the permitted operating parameters.
- Make sure the product is operated in its permitted limitations.
- Do not exceed or undercut the permitted storage and operation temperature and pressure.
- The product should be maintained and calibrated frequently, at least annually.

General safety instructions

- It is not allowed to use the product in explosive areas.
- Please observe the national regulations before/during installation and operation.

Remarks

- It is not allowed to disassemble the product.

**ATTENTION!****Measurement values can be affected by malfunction!**

The product must be installed properly and frequently maintained, otherwise it may lead to wrong measurement values, which can lead to wrong results.

Storage and transportation

- Make sure that the transportation temperature of the device is between -10 ... +50°C.
- For transportation it is recommended to use the packaging which comes with the device.

- Please make sure that the storage temperature of the device is between -10 ... +50°C.
- Avoid direct UV and solar radiation during storage.
- For the storage the humidity must be <90%, no condensation.

2 Registered trademarks

SUTO®	Registered trademark of SUTO iTEC
MODBUS®	Registered trademark of the Modbus Organization, Hopkinton, USA
HART®	Registered trademark of the HART Communication Foundation, Austin, USA
Android™, Google Play	Trademarks of Google LLC

3 Application

The S120 Oil Vapor Monitor is designed to monitor oil contents and dew point (option) in compressed air and gases within the permissible operating parameters. These parameters can be found in the technical data section.

The S120 is mainly used in compressed air systems in industrial environment. The S120 is not developed to be used in explosive areas. To evaluate its applicability in explosive areas, please contact the manufacturer.

4 Features

- Measures oil vapor contents and pressure dew point (optional) in compressed air and other gases.
- Easy connection through sampling hose and quick connect.
- Applicable in the permanent or portable applications.
- Measures down to 0.001 mg/m³.
- PID sensor for the highest accuracy.
- Optional dew point sensor with dual-sensor technology for high accuracy over the whole range from -100 ... +20 °C Td.
- Service and alarm indication through LEDs.
- Connectable to display and data logger of SUTO as well as third-party display and control units.
- IP65 casing provides robust protection in rough industrial environment.
- Optional local display for showing actual readings without extra cable connection.
- Supports multiple interfaces for signal outputs and electrical connections.

5 Technical data

5.1 Measuring parameter

Parameter	Unit	Range	Resolution	Accuracy
Oil vapor	mg/m ³	0.001 ... 5.000 mg/m ³ *	0.001 mg/m ³	5% of reading ± 0.003 mg/m ³
Pressure	bar(g)	0 ... 16 bar(g)	0.01 bar(g)	0.5% FS
Temperature	°C	0 ... 50°C	0.1°C	0.5°C
Dew point (Optional)	°C Td	-100 ... +20°C Td	0.1°C Td	±1°C Td (0 ... 20°C Td) ±2°C Td (-70 ... 0°C Td) ±3°C Td (-100 ... -70°C Td)

* Based on 1000 hPa(a), 20°C, 0% relative humidity

5.2 General data

	
Principle of measurement	<ul style="list-style-type: none"> • Photo ionization • Oscillating crystal (optional)
Sensor	<ul style="list-style-type: none"> • PID (photo ionization detector) • Piezzo resistive pressure sensor • QCM + Polymer (optional)
Measuring medium	Compressed air and gases free of corrosive, aggressive, caustic and flammable constituents
Sample flow range	< 2 l/min, measuring gas is released to ambient
Operating temperature	0 ... +50°C
Gas humidity	< 40% rel. humidity, no condensation
Operating pressure	3 ... 15 bar(g) 0.5 ... 3 bar(g) (Low pressure version)
Housing material	PC, Al alloy
Protection class	IP65
Dimensions	See dimensional drawing on page 11 .
Display (optional)	5" color touch screen with a data logger of 100 million measurement values

Weight	<ul style="list-style-type: none"> • 2.4 kg • 2.58 kg (with dew point sensor)
UV lamp lifetime	9,000 working hours

5.3 Electrical data

Power supply	24 VDC \pm 5%, 10 W
--------------	-----------------------

5.4 Output signals

Analog output	4 ... 20 mA
Alarm output	Relay, NO, 40 VDC, 0.2 A
Digital interface	RS-485, Modbus/RTU, Ethernet, Modbus/TCP, USB (available for display version)

5.5 Minimum measurement time

A measurement duration of approximately 20 minutes is recommended for the S120 to ensure stable and accurate measurement data.

Different oil vapor concentrations and input pressures will require different measurement times.

To ensure measurement accuracy, you can contact SUTO based on your actual operating conditions to obtain a precise recommended measurement duration.

6 Dimensional drawing

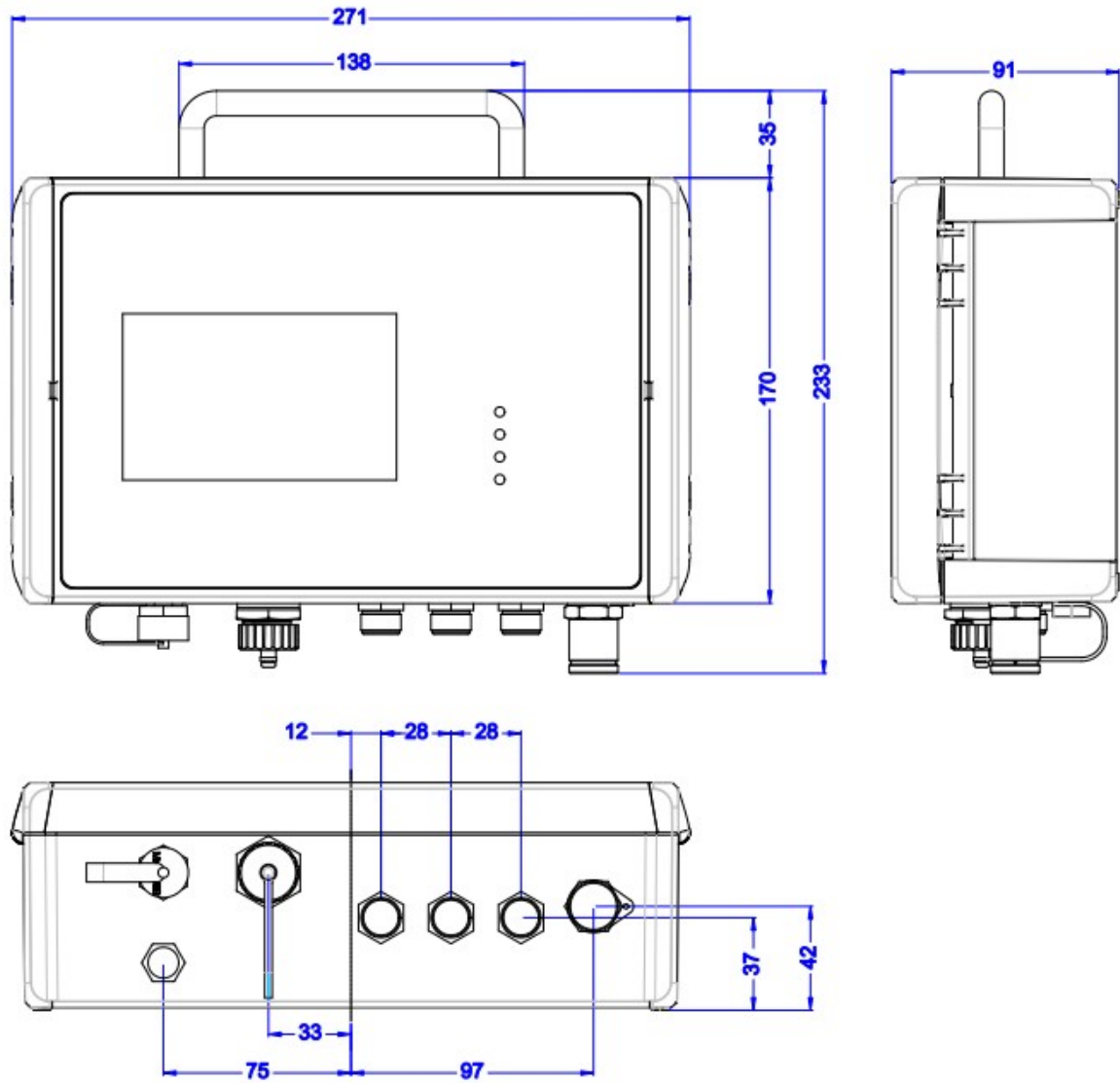

7 Installation

Please make sure that all components listed below are included in your package.

Qty	Description	Item No.
1	S120 Oil Vapor Monitor	S604 1201, S604 1202, S604 1203, S604 1204, S604 1205, S604 1206, S604 1207, S604 1208
3	M12 connectors or M12 cables (depending on orders)	Connector: C219 0059 Cable: A553 0104 / A553 0105
1	Mains unit (100 ... 240 VAC)	A554 0107
1	1.5 m teflon hose with a quick connector and a compressed air coupling at the ends	A554 3316
1	Mounting brackets	No
1	Instruction manual	No
1	Calibration certificate	No

7.1 Installation requirements

The S120 comes with two versions:

- S120 for stationary use. The stationary version comes with four mounting brackets which can be mounted from the backside of the instrument at each corner. This allows an easy installation at a wall.
- S120-P for portable use. The portable version comes in a transport case.

7.2 Wall mounting instructions

The device can be mounted on the wall using the supplied brackets. Please use one of the following dimensions to prepare your holes.

Method 1.

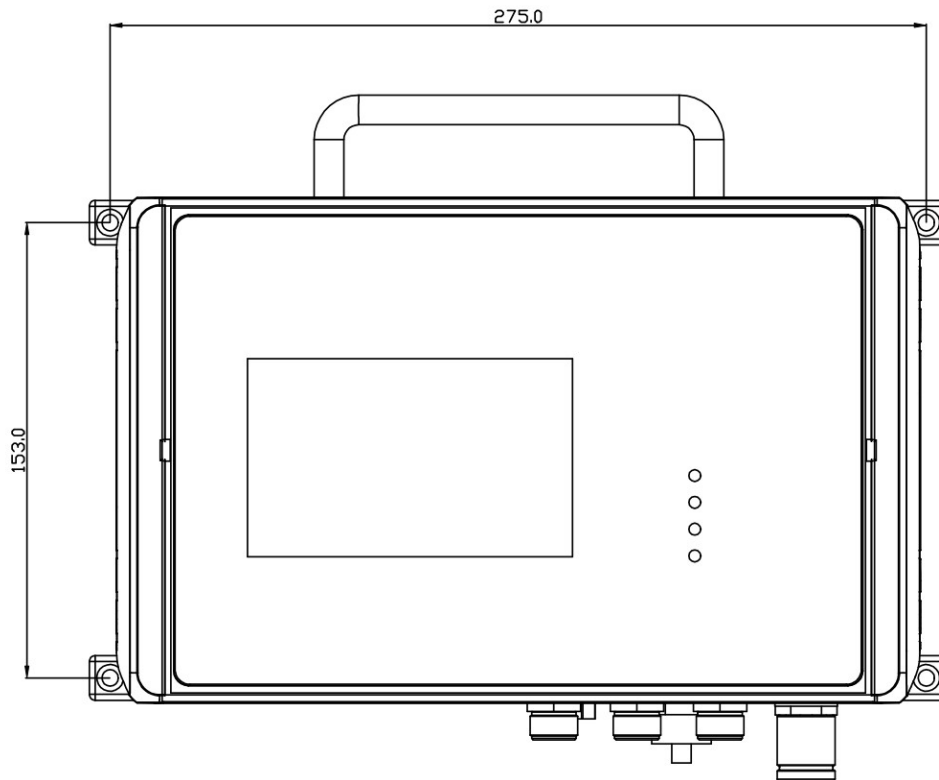

Method 2.

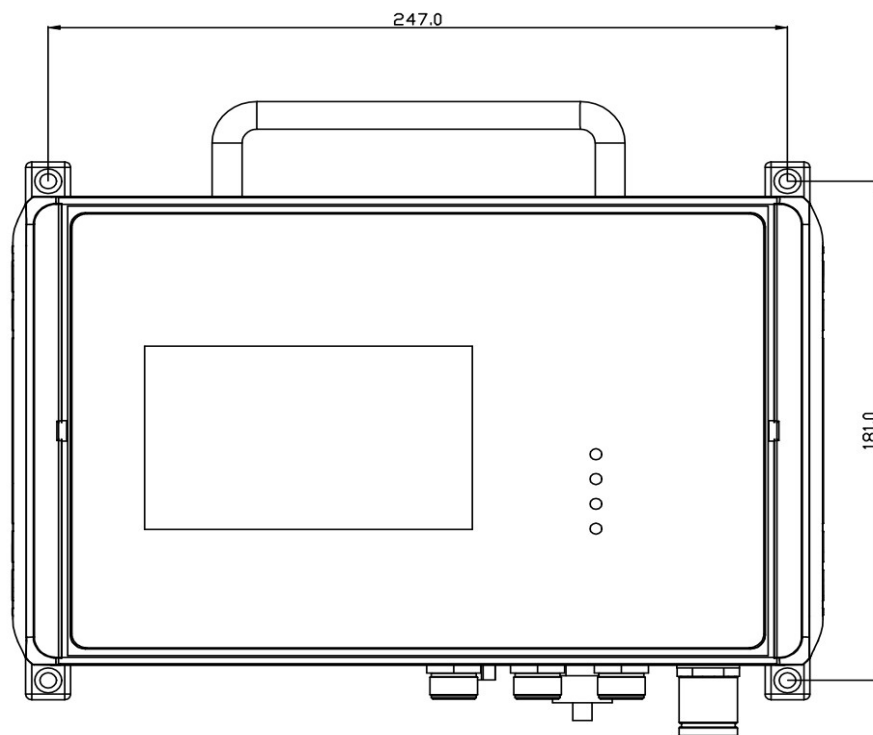

7.3 Installation procedure

7.3.1 Installation requirements

Please consider the following recommendations for a successful measurement result:

- All components from the sampling point to the S120 must be oil and grease free.
- Ambient and gas temperature must be within the specified ranges stated in section [General data](#).
- The inlet gas must be pressurized with the valid ranges.
- The sampling gas must be dry (< 40% RH) and clean.
- Ensure that valves at the sampling point are not lubricated.



ATTENTION!

Avoid contamination with oil or grease!

It will lead to very slow measurement or impossible measurement results!

- Make sure that there is no rough contaminants at the point of measurement. Steps are as follows:
 1. Connect the purge filter test kit onto your measuring point first. Open the purge valve on the test kit and purge air for a short period.
 2. Check the filter in the test kit to see whether it shows high contamination of water, oil or dust.
 3. If the filter is contaminated severely, stop using the S120 for measurement because this may lead to serious damage to the device. In case you are not sure, please contact the manufacturer.



ATTENTION!

Before you connect the device to your point of measurement, make sure that there is no rough contamination like water/oil drops or heavy dust. This may damage the sensor units. For this please use the purge filter test kit.



7.3.2 Installation steps

The following steps explain the procedure of an appropriate installation.

Most importantly, before you connect S120 to the compressed air, purge air out from the measuring point to remove any residual contamination using the purge filter test kit.



1. Connect the teflon hose with the inlet of the S120 as shown in the picture.



2. Connect the other end of the teflon hose with a quick connector. The teflon hose with quick connector is used to connect the S120 to the process.

7.4 Electrical connection

The S120 provides 3 kinds of electrical connections by the following interfaces:

- One USB port
- One RJ-45 connector
- Three M12 connectors

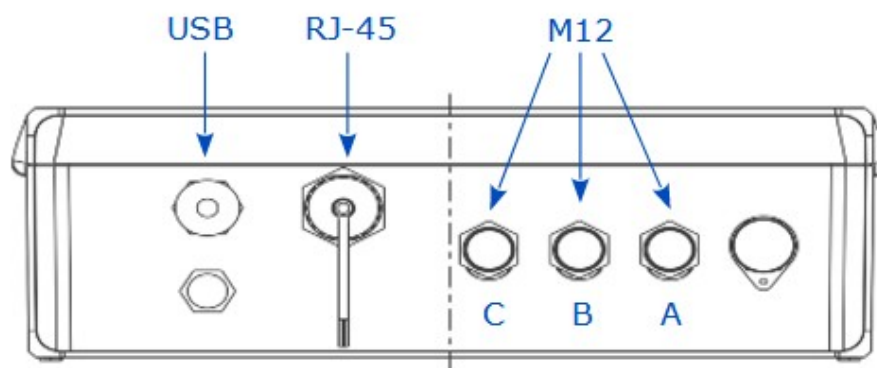

7.4.1 USB port

The USB port is used to import or export files.

Through the USB port, the S120 can be connected with:

- An OTG memory stick: To import firmware for upgrade and to export data.
- A PC where data analysis software such as S4A is installed: To export data to the PC for analysis.

7.4.2 RJ-45 connector

The RJ-45 connector is used as an Ethernet port for IP networking.

Through this connector, the S120 connects to the TCP/IP network over the Modbus/TCP protocol.

7.4.3 M12 connectors

The 3 M12 connectors are used to connect to display units from SUTO or the third-party displays and control units.

Also, the S120 is powered through these connectors.

Connection to the following external display units from SUTO.

S120		Color code	S330/S331		S320	
Pin	Signal		Terminal	Pin	Terminal	Pin
A.1	SDI	brown	A	1	G	6
A.2 / B.2	-V _b	white		2		7
A.3 / B.3	+V _b	blue		3		8
C.4	D+	black		4		
C.5	D-	grey		5		
B.1	PE	brown		GND		
A.1	SDI	brown	B	1		
A.2 / B.2	-V _b	white		2		
A.3 / B.3	+V _b	blue		3		
C.4	D+	black		4		
C.5	D-	gray		5		
B.1	PE	brown		GND		

S120 without display - M12 pin assignment

Connector	Pin 1	Pin 2	Pin 3	Pin 4	Pin 5
A	SDI	-V _b	+V _b	D+	D-
B	PE	-V _b	+V _b	+I	-I
C	Relay	Relay	GND	D+	D-
Color	Brown	White	Blue	Black	Gray

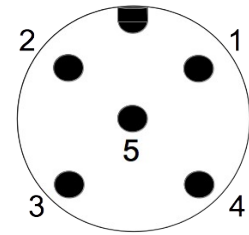

S120 with display - M12 pin assignment

Connector	Pin 1	Pin 2	Pin 3	Pin 4	Pin 5
A	SDI	-V _b	+V _b	NA	NA
B	PE	-V _b	+V _b	+I	-I
C	Relay	Relay	GND	D+	D-
Color	Brown	White	Blue	Black	Gray

Legend to pin assignment

SDI	Digital signal (internal use)
-V _B	Negative supply voltage
+V _B	Positive supply voltage
+I	Positive 4 ... 20 mA signal
-I	Negative 4 ... 20 mA signal
D+	RS-485, Modbus/RTU
D-	RS-485, Modbus/RTU
Relay	Alarm output
PE	Earth connection
GND	Communication ground
NA	Not applicable

8 Configuration

The S120 is delivered with standard ex-work configuration or with specific customer settings according to the order.

Standard ex-work configuration

Scaling	: 4 mA = 0.000 mg/m ³ 20 mA = 5.000 mg/m ³
Alarm	: 1.000 mg/m ³ , up
Oil type	: Isobutene
Modbus	: Device address = Last two digits of the serial number Baud rate = 19200 Framing/parity/Stop bit = 8, N, 1 Transmission mode = RTU

You can use one of the following ways to configure S120.

8.1 Integrated display

See Chapter [Operations using the integrated display](#).

8.2 External display device

See the S330/S331 Instruction Manual.

8.3 Service kit

Please ensure that S120 or the service kit is connected with the power supply because the USB port cannot supply enough power for both of them.

For more information, refer to the instruction manual of Service Kit.

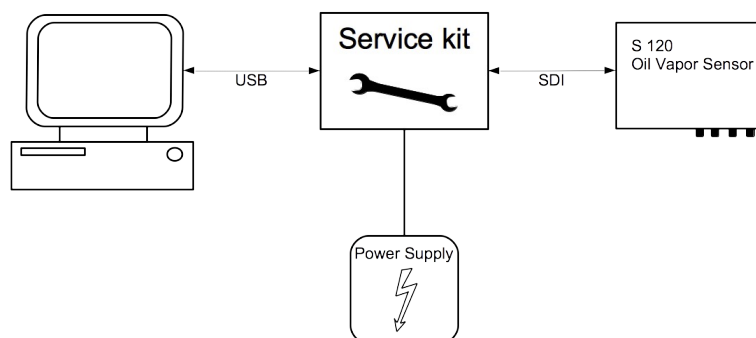

9 Operations using the integrated display

If your S120 is equipped with the optional integrated display, you can configure the device by using the display.

This chapter describes the usage of the display and provides instructions on how to configure the device .

9.1 User interface

The screen below shows the user interface of the S120.

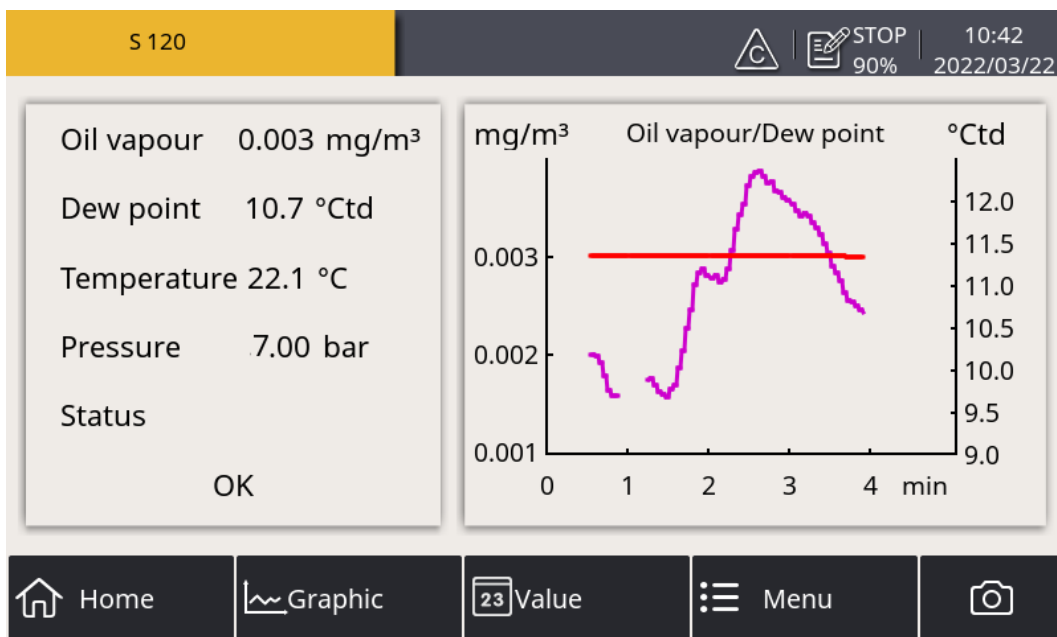

9.1.1 Main screen

- On the left side the online measuring values are shown:
 - **Oil vapor:** Oil vapor content per cubic meter at reference condition
 - **Dew point:** pressure dew point (optional, only shown if the dew point option is chosen.)
 - **Temperature:** Medium temperature
 - **Pressure:** System pressure
 - **Status:** Sensor status (for service)
- On the right side the online graphic view is shown.

Note: An oil vapor reading of 0.555 indicates a fault in the S120. See section 11.2 Errors and actions on how to handle the error.









9.1.2 Quick buttons

The quick buttons and their functions are described below.

Home	To return to the home view which is shown above.
Graphic	To show the graphic in full screen.
Value	To show the values in full screen.
Menu	To configure the sensor and other device settings. For more information, see Section Main menus .
Camera	To capture an image of the current screen and store it in the memory for any future retrieve through the S4A data logger software.

9.1.3 Status bar

Description of icons displayed in the status bar.

	USB stick connected		System error
	Sensor connection has changed, not matching with configuration		Sensor unit is not matching with configuration
	Logger status		RTC backup battery status
	Sensor calibration is expired		Alarm triggered

9.2 Main menus

After you click the **Menu** button, the following screen appears displaying all operating menus.

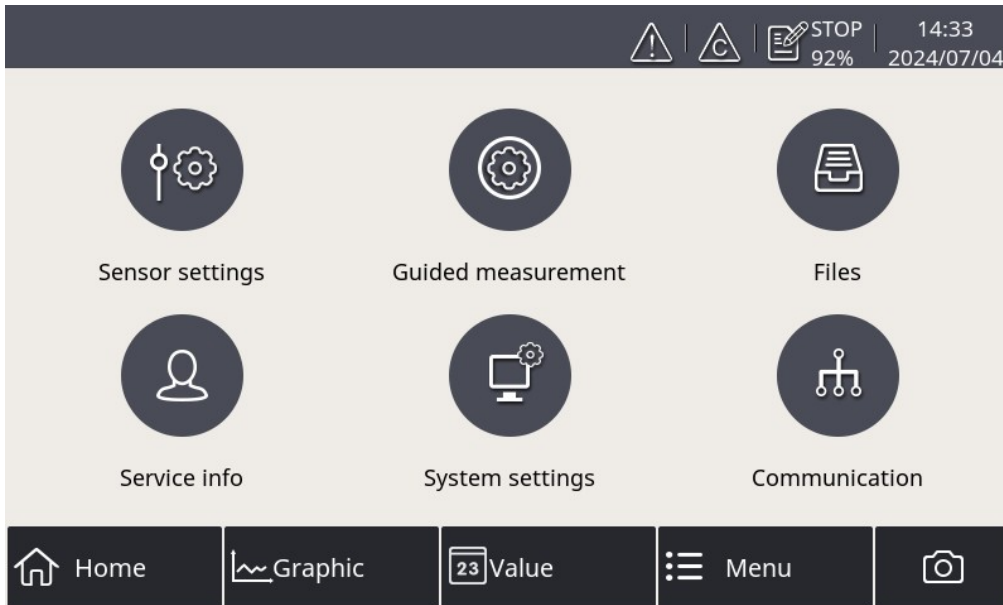

The main menus and their functions are described below.

Sensor settings	To view and check the S120 settings.
Guided measurement	To start the guided measurements, which lead you through a complete measurement process.
Files	To check all screen-shots and the memory status.
Service info	To view useful information in case of a service issue.
Service setting	To view service related settings.
Communication	To configure the field bus RS-485 and Ethernet Modbus/TCP.

9.3 Sensor settings

To configure sensor settings before starting measurement.

After you changes settings, click "Save" to have the changes saved in the S120.

9.3.1 Basic setting

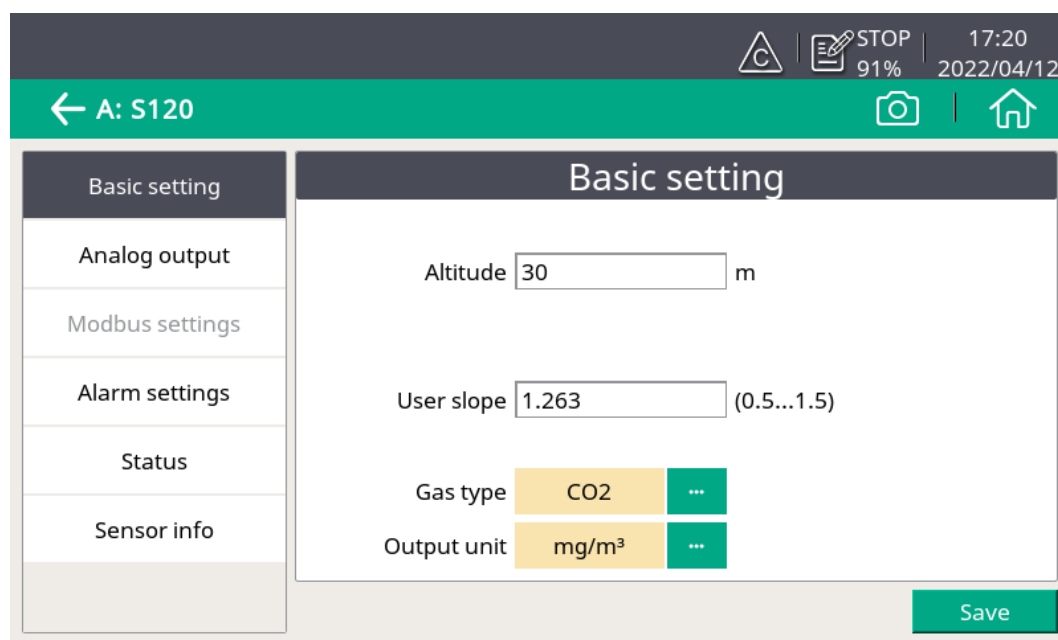

Altitude	To enter the Altitude. To accurately measure oil vapor, enter the altitude where the device is placed. Valid values are only positive. If you are in a location where the real altitude is negative, enter 0 instead of a negative value.
User slope	To enter a value in the value range. Usually, enter 1.0.
Gas type	To select the gas type from Air, N ₂ , and CO ₂
Output unit	To select the desired output unit.

9.3.2 Analog output

To configure the scaling of analog output. Whenever the output unit is changed, it is recommended to adjust the scaling of the analog output.

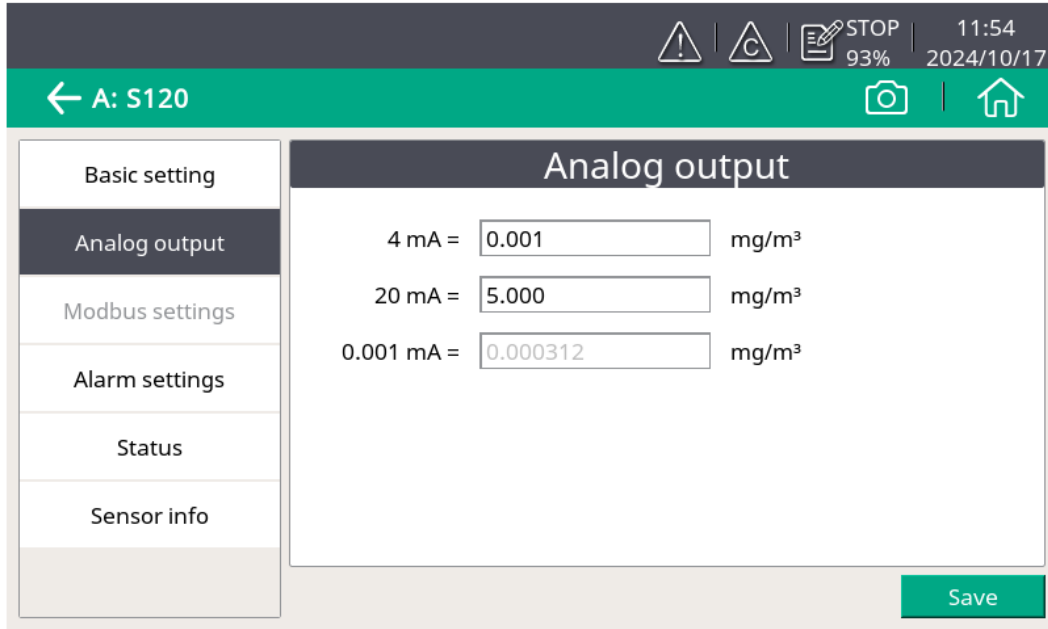

9.3.3 Alarm settings

To configure the threshold of oil vapor that triggers the alarm.

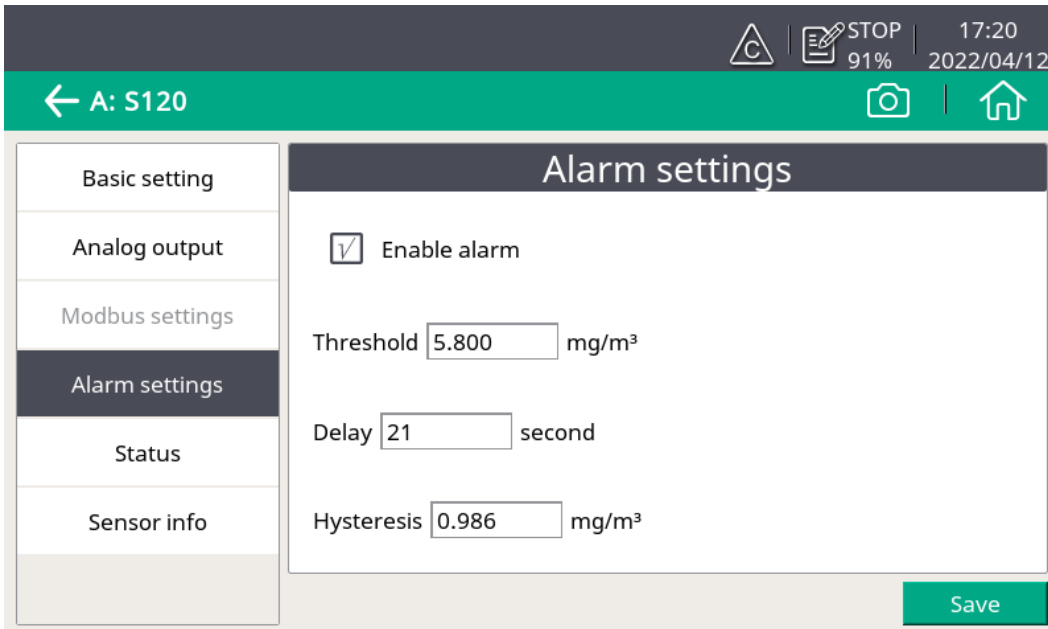

9.3.4 Status

To check the device status in case of a service issue.

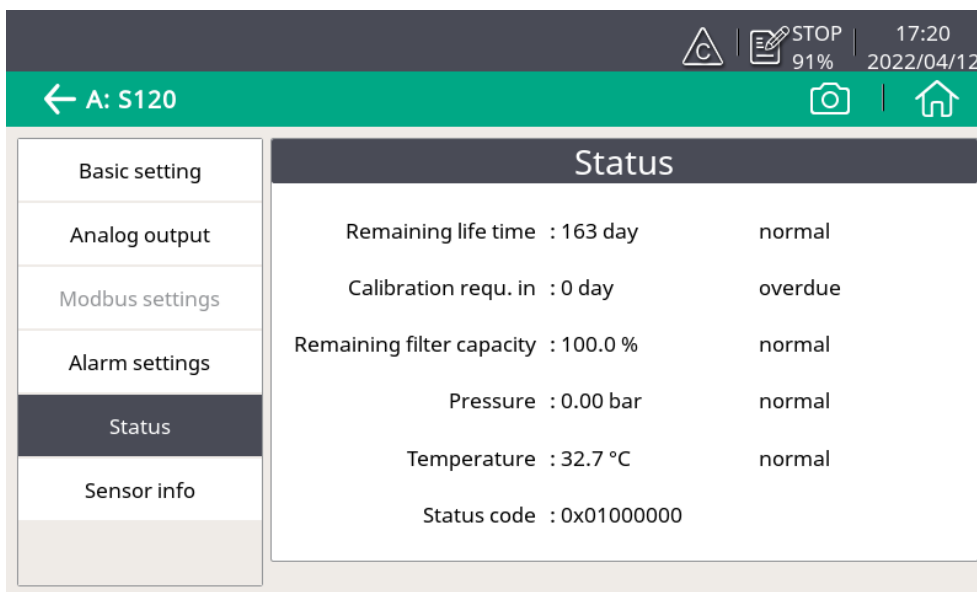

9.4 Guided measurement with PDF report generation

To start the different measurement and monitoring according to your requirement.

The recorded file and report can be viewed after the measurement is done. For more information, see Chapter 10 Guided measurement.

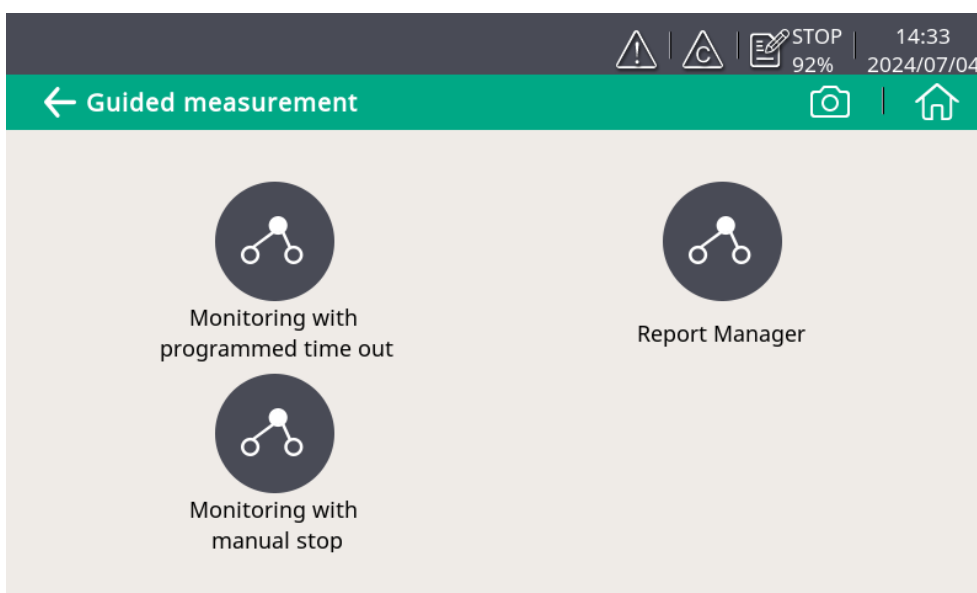

9.5 Files

To view screen-shots and the available memory.

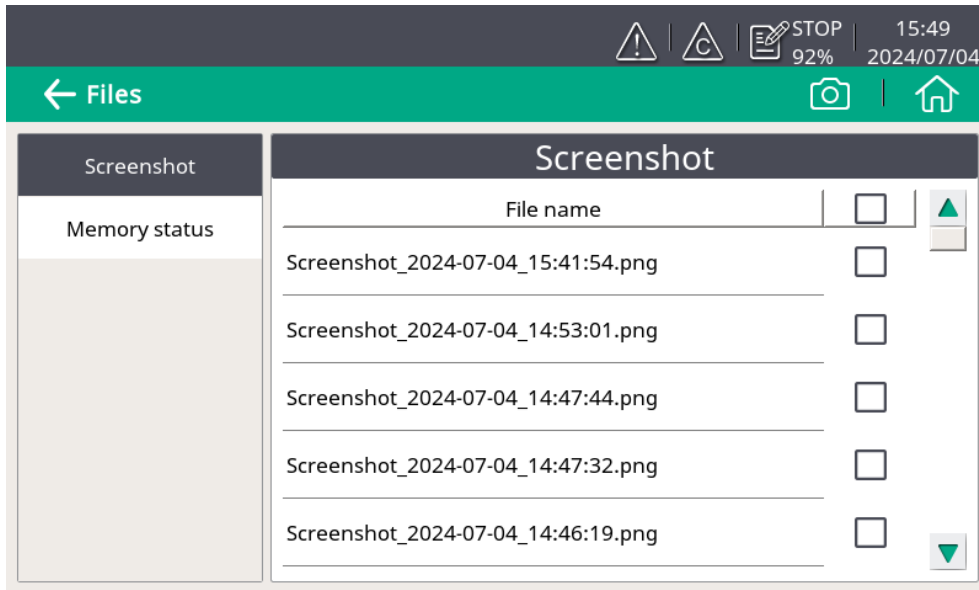

9.6 Service info

To view the contact information of the company that provides the service.

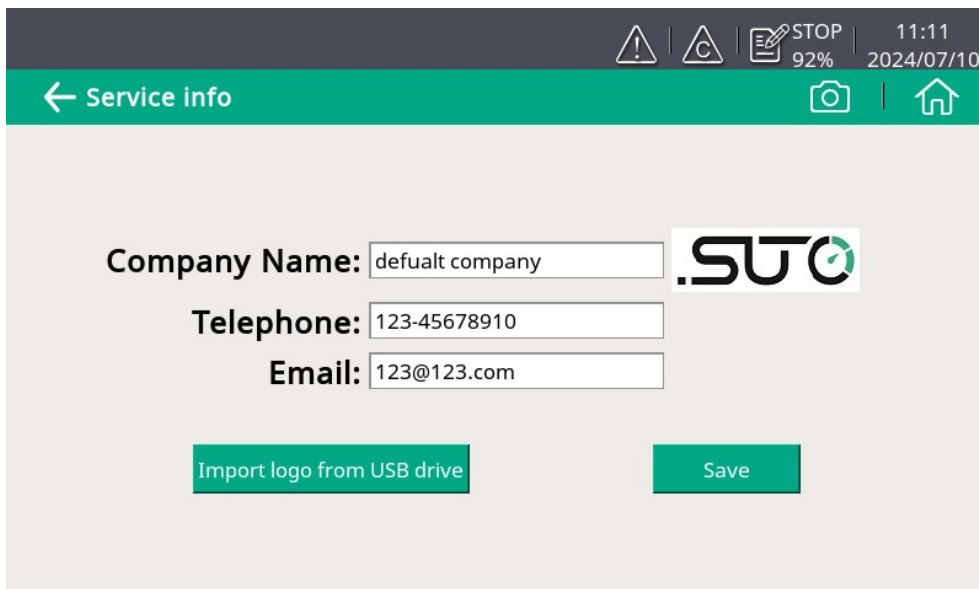

9.7 System settings

To view and change S120 system-level settings.

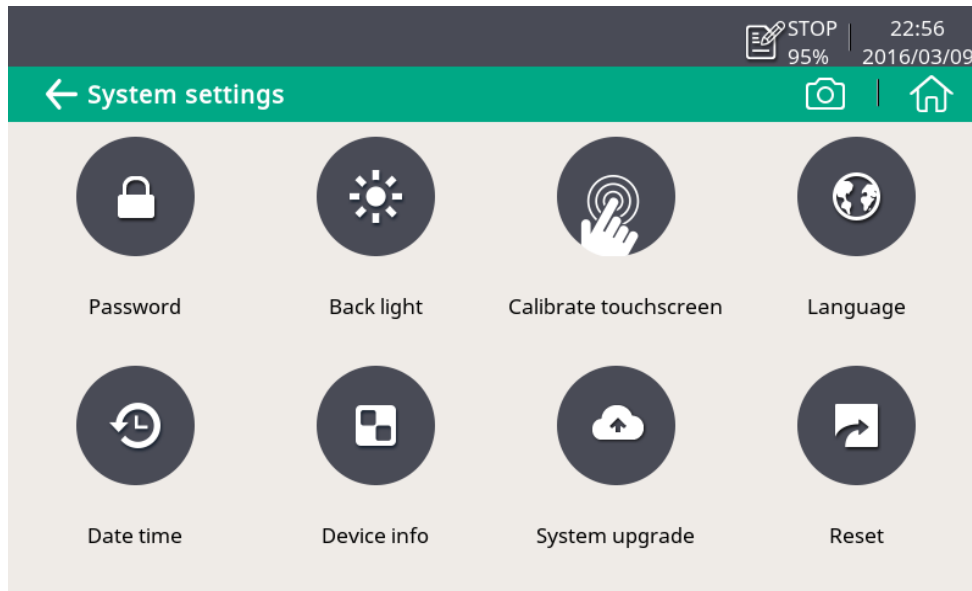

Password	To set the password to protect some critical operations from unauthorized access.
Back light	To adjust brightening and dimming time out.
Calibrate touch screen	To calibrate touch accuracy
Language	To select the user interface language
Date time	To set the date and time
Device info	To show information for service cases
System upgrade	To upgrade the system.
Reset	To reboot the display.

9.8 Communication

To configure the field bus RS-485 and Ethernet Modbus/TCP.

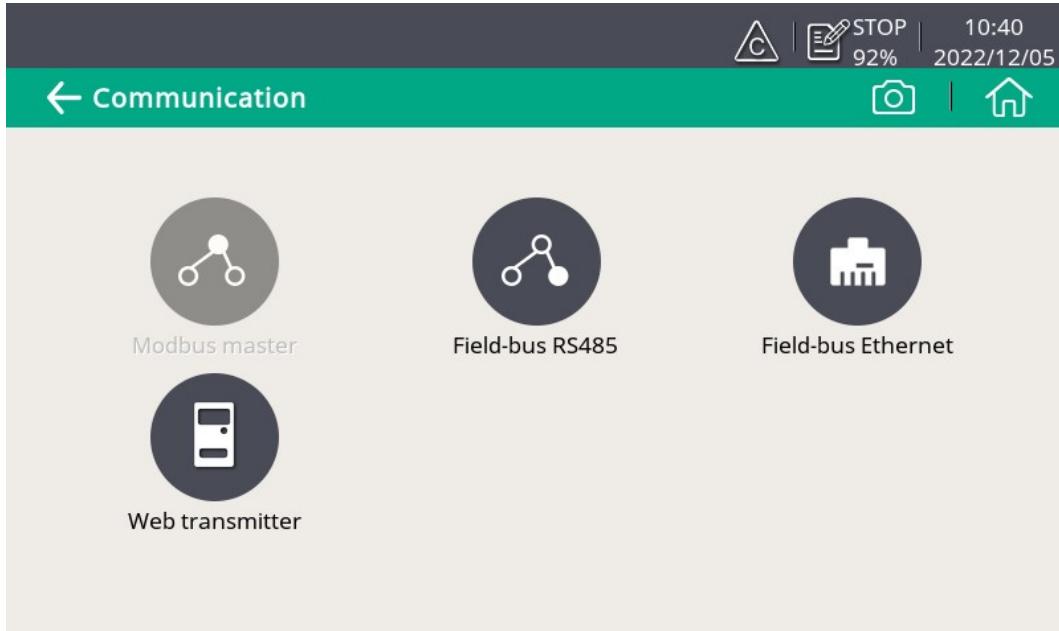

9.8.1 Modbus/RTU settings

To change the Modbus/RTU settings.

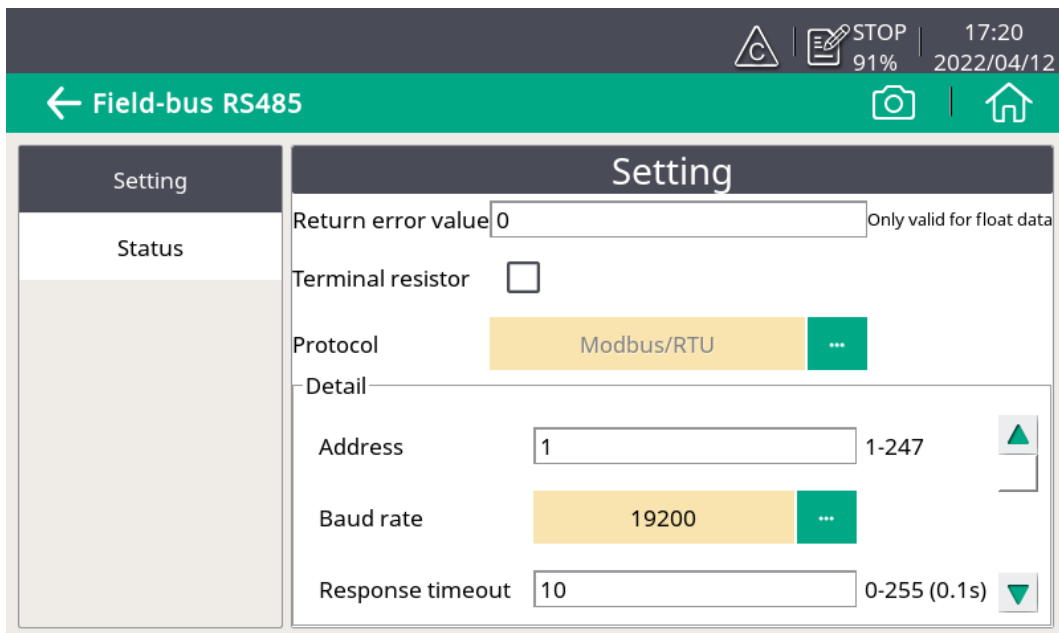

9.8.2 Modbus/TCP settings

To change the Modbus/TCP settings.

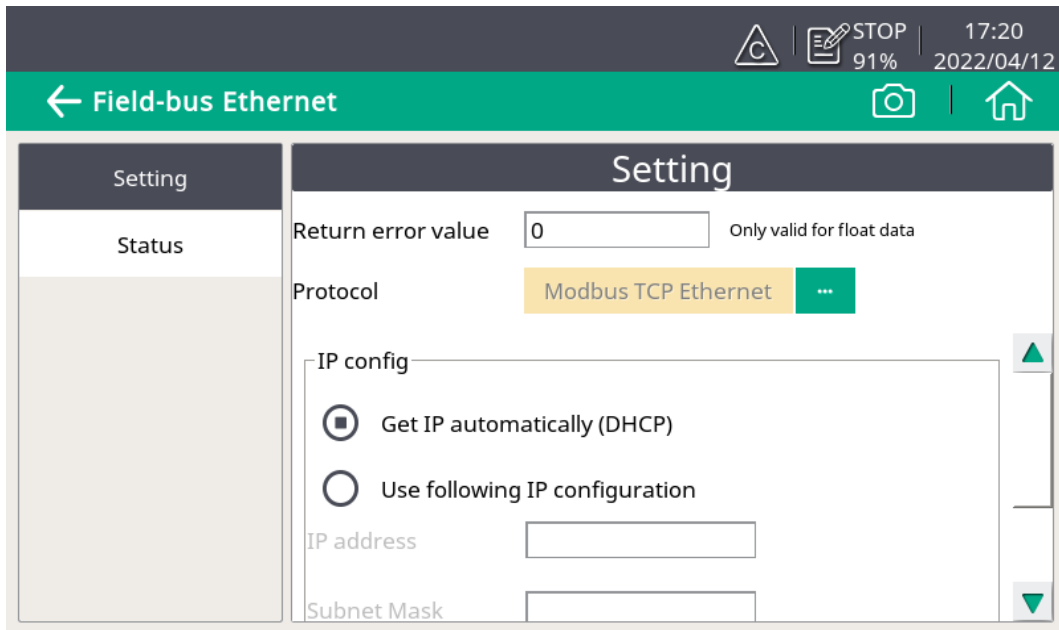

10 Guided measurement

The S120 provides a software-based guided measurement which takes you through the complete measurement. This leads to a simplified measurement process and prevents you from wrong measurements.

Finally, a PDF report can be created from the measurement series.

To start a guided measurement, do the following:

1. Click **Menu > Guided measurement**.

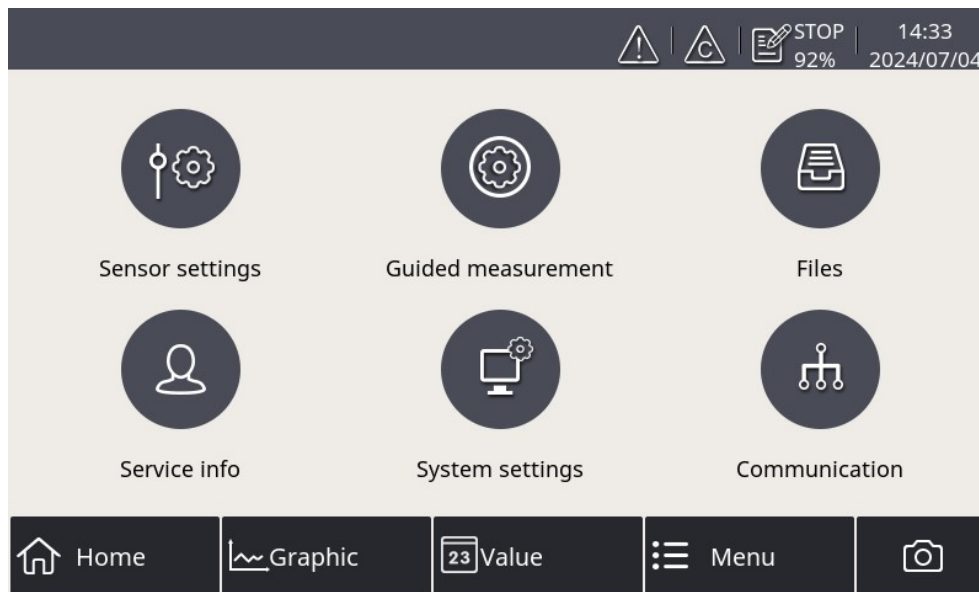

2. Select the type of measurement that you want to perform.

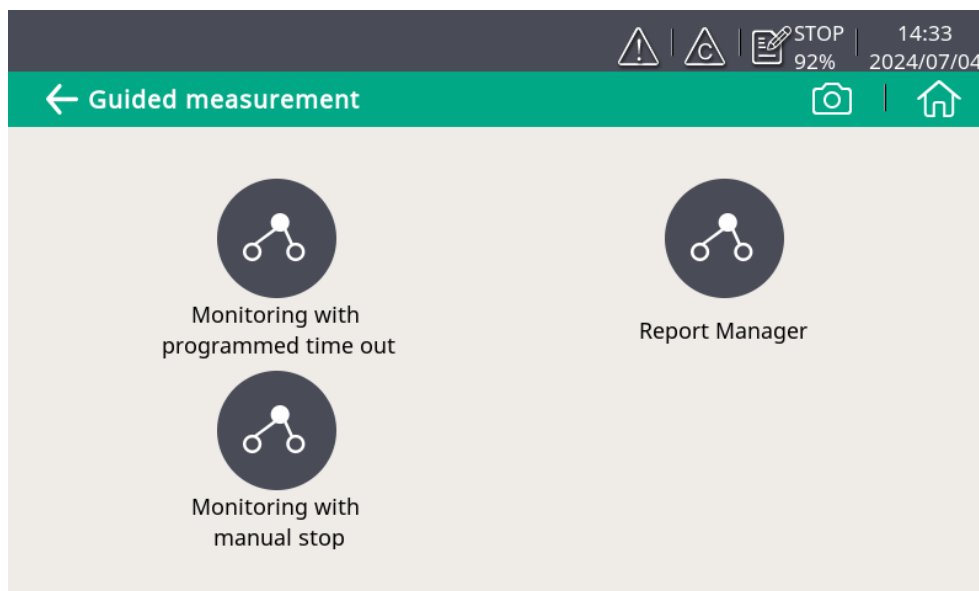

- **Monitoring with programmed time out:** It starts a measurement with a user-programmed period of measurement

time. You can set the measurement time during the process of measurement preparation. The system will then, after finishing the programmed measurement duration, stop the measurement automatically and save the data. This mode is ideally used for audits where you must measure at several points. You can program for each point a duration of e.g. 2 hours and then you can compare the measurements.

- **Monitoring with manual stop:** It starts the measurement without a programmed stop time. You can click it to start the measurement and stop it whenever you want. Then you can decide if you want to save or delete the data. This can be used to monitor changes in values.
3. Perform the guided measurement following the onscreen instructions. For more information, see section 10.1 Steps for guided measurement.
 4. To view and manage the measurement files generated, click **Report Manager**. For more information, see section [10.2 Report for guided measurements](#).

10.1 Steps for guided measurement

After you start a guided measurement, follow below steps to go through the whole process.

Note: Dew point measurement is only available if the S120 has been ordered with the dew point sensor.

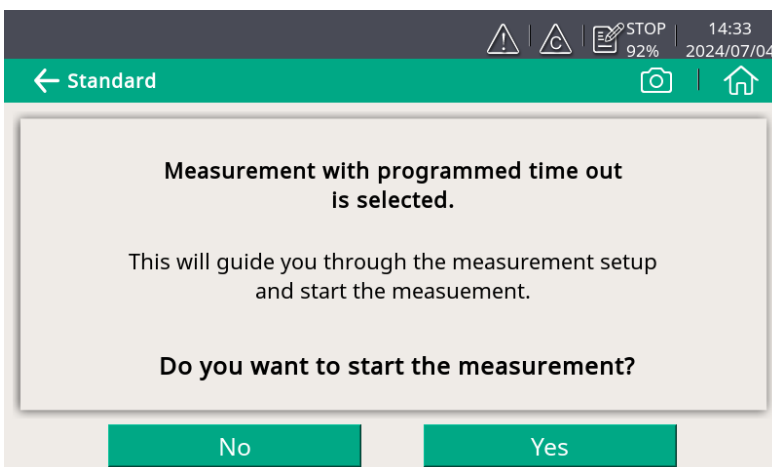

1. An overview is given about the selected measurement types. Click **Yes** to start.

Standard

STOP 92% 14:45 2024/07/04

Please input your customer and tester details for the report

Customer: SUTO ITEC Co. Ltd

Tester: LI

Location: Location

Measuring point: Measurement point

File Name: SUTO

Back Next

Standard

STOP 92% 14:45 2024/07/04

Please input your altitude

Altitude: 23 m (Over sea level)

Back Next

Standard

STOP 92% 14:45 2024/07/04

Please select the target class of the ISO 8573-1 compressed air purity standard. The selected class will be used for evaluation in the report.

Oil Vapor CLASS 0 CLASS 1 CLASS 2 CLASS 3 CLASS 4
custom

Dew Point CLASS 0 CLASS 1 CLASS 2 CLASS 3 CLASS 4 CLASS 5
custom

Back Next

2. Input the customer and tester names, which will be shown on the report.

3. Input the altitude where the device is placed.

Note: Altitude is needed for an accurate oil vapor measurement. Only positive values are valid. If the altitude is negative, enter 0 instead of the real negative value.

4. Select the compressed air class as needed.

Note: ISO8573 stipulates alarm limit values for different classes.

CLASS 0 allows you to customize the alarm limit values.

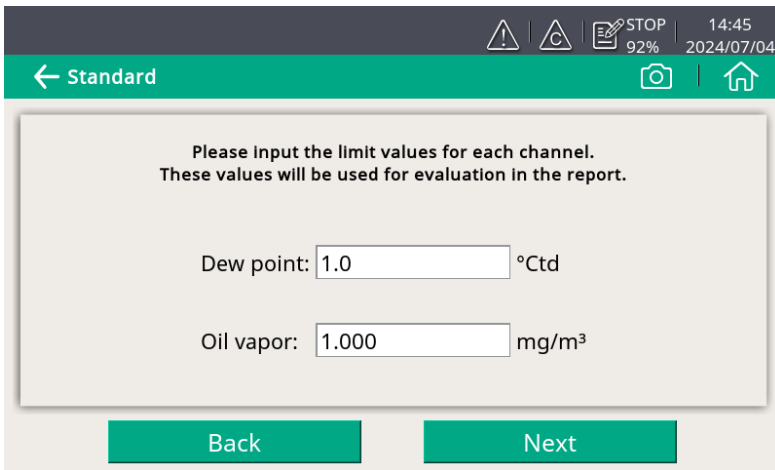

5. Enter a limit value for each measurement channel.
(This step is shown only when you selected CLASS 0 in the last step)

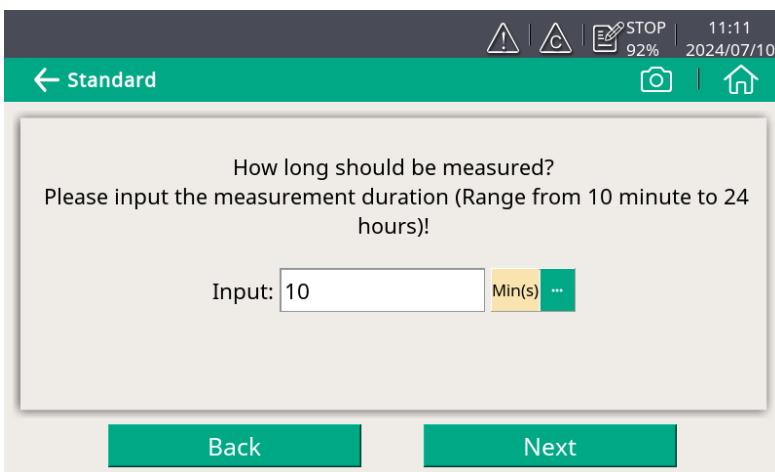

6. Enter the measurement duration.

Note: It takes a period of time to obtain stable and accurate data after the S120 is powered on. Please set a proper measurement time based on the actual situation. See section 5.5 for the minimum measurement time.

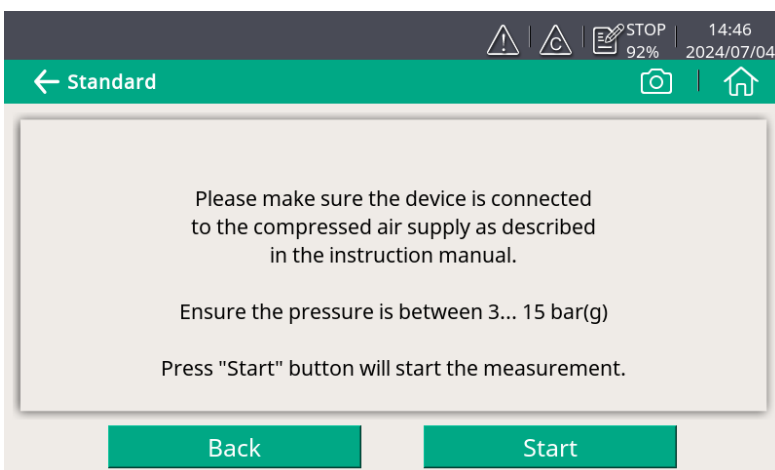

7. The system checks whether the compressed air is connected and the pressure is within the valid range.

Click **Start** to start the measurement.

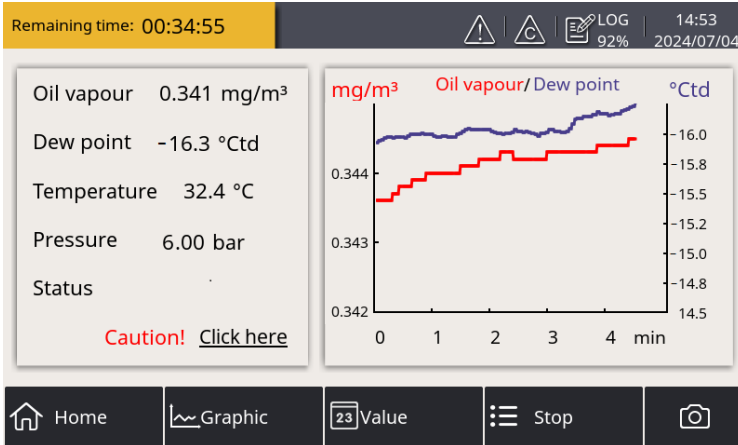

During the measurement, you can see the Data logger status icon on the status bar switched from STOP to LOG. The remaining time is displayed in the upper left corner. Please wait until the system completes the measurement.

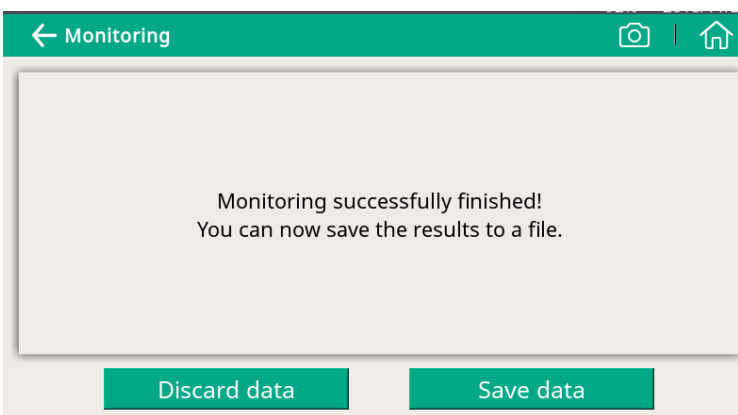

When the measurement is successfully completed, the screen on the left appears. Choose to discard or save the measurement data as needed.

10.2 Report for guided measurements

After performing guided measurements, you can view and manage measurement files through **Guided Measurement > Report Manager**.

← Report

Index	Measurement type	Log file	Start time	<input type="checkbox"/>
0	Monitoring	LOG00026.CSD	08.11.2018 09:12	<input checked="" type="checkbox"/>
1	Standard	LOG00025.CSD	10.10.2018 10:44	<input type="checkbox"/>
2	Monitoring	LOG00022.CSD	09.10.2018 13:22	<input type="checkbox"/>
3	Standard	LOG00021.CSD	05.09.2018 11:31	<input type="checkbox"/>
4	Monitoring	LOG00020.CSD	05.09.2018 11:14	<input type="checkbox"/>

Delete Copy raw-data to Export





- To view the measurement results, click on the file (not the check box on the right). A window appears showing the PDF for your preview.
- To copy, export or delete files, select the file check boxes, and then click the corresponding button at the bottom.

Export	Creates the PDF report and saves it to the USB stick.
Delete	Permanently deletes the measurement data.
Copy raw data to	Copies the raw measurement data to the USB stick (*.csd).

11 Troubleshooting

This chapter describes how to troubleshoot S120 based on error indications such as LED indicators, relay status, and current output.

11.1 LED indicators

 Power	Indicates the power status.
 Alarm	Indicates the alarm status.
 Service Sensor	Indicates whether the sensor need to be serviced.
 Service Filter	Indicates whether the service filter need to be replaced.

11.2 Errors and actions

LED	Status	Causes	Action
Power (Green)	On	Normal power supply to S120	NA
	Off	Device is off / Power failed	NA
Alarm (Red)	On	Value over threshold (Alarm triggered)	Oil vapor/dew point alarm, take relevant measurements.
		Value over measuring range	
		Filter capacity < 1%	Contact the manufacturer for maintenance/ calibration/ filter replacement service.
		Calibration expired	
		Auto-calibration failed	
		Inner communication failed	
		Sensor real lifetime expired	
	Blinking	Calibration overdue soon (< 30 days)	Pay attention and schedule calibration/ filter replacement services in advance.
		Filter capacity < 10%	
		Sensor real lifetime overdue soon (< 30 days)	
		Temperature too low	Check the environment conditions and improve accordingly.
		Temperature too high	
		Pressure too low	
Pressure too high			
Service Sensor (Yellow)	Blinking	Calibration overdue soon (< 30 days)	Pay attention and schedule calibration/ filter replacement services in advance.
		Sensor real lifetime overdue soon (< 30 days)	
		Inner communication failed	
	On	Calibration expired	Contact the manufacturer for maintenance/ calibration/ filter replacement service.
		Auto-calibration failed	
		Sensor real lifetime expired	
Service Filter (Yellow)	On	Filter capacity < 1%	Contact the manufacturer for maintenance/ calibration/ filter replacement service.
		Auto-calibration failed	
	Blinking	Inner communication failed	Schedule calibration/ filter replacement services.
		Filter capacity < 10%	

Relay/ Current	Status	Causes	Action
Relay	Open	Temperature too low	Check the environment conditions and improve accordingly.
		Temperature too high	
		Pressure too low	
		Pressure too high	
		Value over threshold (Alarm triggered)	Oil vapor/dew point alarm, take relevant measurements.
		Value over measuring range	
		Inner communication failed	Contact the manufacturer for maintenance/ calibration/ filter replacement service.
		Filter capacity < 1%	
		Auto-calibration failed	
		Sensor real lifetime expired	
	Close	Calibration expired	Pay attention and schedule calibration/ filter replacement services in advance.
		Calibration overdue soon (< 30 days)	
Filter capacity < 10%			
Sensor real lifetime overdue soon (< 30 days)			
Current output	Normal	Calibration overdue soon (< 30 days)	Pay attention and schedule calibration/ filter replacement services in advance.
		Filter capacity < 10%	
		Sensor real lifetime overdue soon (< 30 days)	
		Value over threshold (Alarm triggered)	Oil vapor/dew point alarm, take relevant measurements.
		Calibration expired	
	21 mA	Sensor real lifetime expired	Contact the manufacturer for maintenance/ calibration/ filter replacement service.
		Filter capacity < 1%	
		Auto-calibration failed	
		Inner communication failed	
		Value over measuring range	Oil vapor/dew point alarm, take relevant measurements.
		Temperature too high	
	3.5 mA	Pressure too high	Check the environment conditions and improve accordingly.
Temperature too low			
Pressure too low			

Readings	Where	Causes	Action
5.555	On display	Filter capacity < 1%	Contact the manufacturer for maintenance/ calibration/ filter replacement service.
		Auto-calibration failed	
		Inner communication failed	
		Sensor real lifetime expired	
	or via Modbus	Temperature too low	Check the environment conditions and improve accordingly.
		Temperature too high	
		Pressure too low	
		Pressure too high	
		Value over measuring range	Oil vapor/dew point alarm, take relevant measurements.

12 Signal outputs

12.1 Analog output

The S120 has an analog output range of 4 ... 20 mA. This output is scaled to:

- 4 mA = 0.000 mg/m³
- 20 mA = 5.000 mg/m³

12.2 Modbus interface

The default settings of the Modbus interface are as follows:

Communication parameters (Modbus/RTU)

Baud rate	: 19200
Device address	: Last digits of serial number
Framing / parity / stop bit	: 8, N, 1
Response time	: 1 second
Response delay	: 0 ms
Inter-frame spacing	: 7 char

Communication parameters (Modbus/TCP)

DHCP	: Yes
MAC	: Set ex-factory
IP address	: Dynamic or Static
Subnet	: Dynamic or Static
Gateway	: Dynamic or Static
Timeout	: ≥ 200 ms

Response message that the device returns to the master:

- Function code: 03

The information for the byte order

Byte Order	Sequence				Data Type
	1st	2nd	3rd	4th	
1-0-3-2	Byte 1 (MMMMMMMM*)	Byte 0 (MMMMMMMM *)	Byte 3 (SEEEEEEE)	Byte 2 (EMMMMMMM *)	FLOAT
1-0-3-2	Byte 1	Byte 0 LSB	Byte 3 MSB	Byte 2	UINT32 INT32
1-0	Byte 1 MSB	Byte 0 LSB	---	---	UINT16 INT16
1-0	Byte 1 XXX *	Byte 0 DATA	---	---	UINT8 INT8

*S: Sign, E: Exponent, M: Mantissa, XXX: no value

Explanations of MSB and LSB

MSB MSB refers to Most Significant Byte first, which follows the Big-Endian byte order.
 For example, if the main system follows the MSB first order:
 When the 4-byte floating number, in the order of Byte1-Byte0-Byte3-Byte2, is received from the slave (sensor), the master must change the byte order to Byte3-Byte2-Byte1-Byte0 for the correct display of the value.

LSB LSB refers to Least Significant Byte first, which follows the Little-Endian byte order.
 For example, if the main system follows the LSB first order:
 When the 4-byte floating number, in the order of Byte1-Byte0-Byte3-Byte2, is received from the slave (sensor), the master must change the byte order to Byte0-Byte1-Byte2-Byte3 for the correct display of the value.

Modbus holding registers (read-only)

Modbus register address	Data type	Data length	Channel description	Unit	Resolution
0	FLOAT	4-Byte	Gas temperature	°C	0.1
2	FLOAT	4-Byte	Oil vapor content	mg/m ³ ppm	0.001
4	FLOAT	4-Byte	Pressure	bar	0.1
6	FLOAT	4-Byte	Remaining life time	day	1
8	FLOAT	4-Byte	Remaining filter capacity	%	0.1
10	UINT32	4-Byte	System status	-	1
12	FLOAT	4-Byte	Sensor output	mV	0.001
20	FLOAT	4-Byte	Dew point	°C Td F Td mg/m ³	0.1

Interpretation of system status

The device provides the device statuses via Modbus as well. The 32-bit data information is read as single bits. The meanings of these bits are described as follows.

Bit	Description	Bit	Description
0	Alarm triggered at oil vapor channel	8	Pressure too low
1	Oil vapor content over range	9	Pressure too high
2	Calibration will overdue soon	10	Temperature too low
3	Calibration overdue	11	Temperature too high
4	Sensor life time will overdue soon	12	Inner communication failed
5	Sensor overdue	13	Sensor signal is too small
6	Filter will overdue soon	14	Sensor signal is too high
7	Filter overdue		

12.3 Alarm output

The S120 has a relay alarm output. It is possible to monitor such as the oil vapor content and give an alarm at a particular threshold value.

Alarm relay specifications:

Rating: 40 VDC, 0.2 A

Power-off state: NO (normally open)

Default threshold value: 1.0 mg/m³

Please find the different states in the table below.

Situation	Relay state	Alarm LED
S120 is powered off	OPEN	OFF
S120 is powered on / no alarm value is reached	CLOSED	OFF
S120 is powered on / alarm value is reached	OPEN	ON

The advantage of the normally open relay is, that both critical situations can be detected, not only if the alarm value is reached, also if the device has power loss.

To power on an external buzzer or alarm light with the device, you need to invert the signal. For this an external alarm circuit is needed in addition. See the example below.

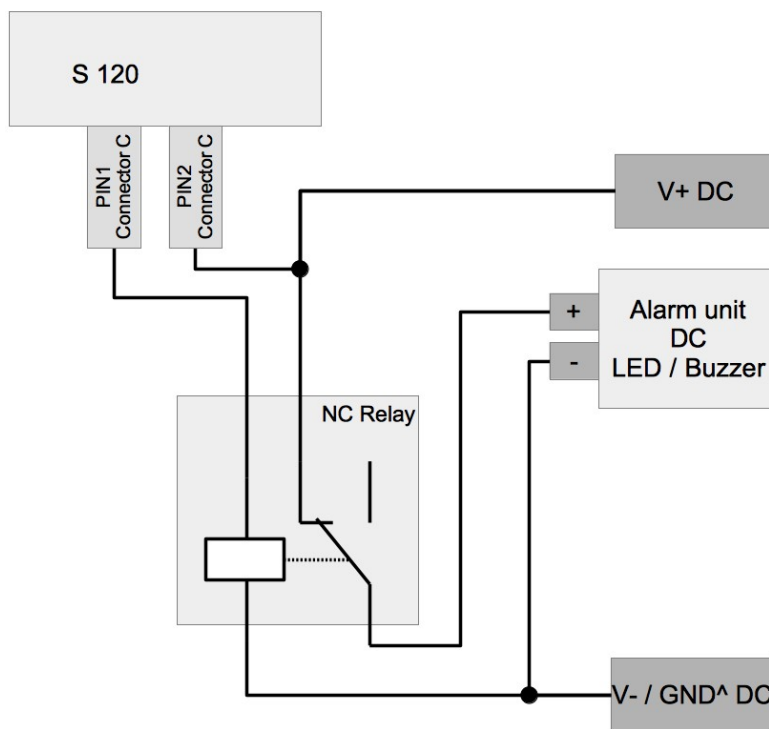

13 Optional accessories

13.1 Sensor display

The sensor display enables you to view the actual values and error messages and change settings.

The sensor display comes with a data logger that can store 100 million measurement values.

13.2 Service kit

The service kit enables you to configure an S120 that is not equipped with the local display. For more information, see section 8.3 [Service kit](#).

14 Calibration

The sensor is calibrated before delivery. The calibration date is printed on the certificate which is supplied together with the sensor.

The sensor's accuracy is affected by environmental factors such as oil, high humidity, or other contaminants, which may influence calibration and overall performance. It is recommended to calibrate the sensor at least once a year. Calibration is not covered under the instrument's warranty. Please contact the manufacturer to request calibration service.

Variations in usage scenarios, operating conditions (for example, high humidity, dust, frequent exposure to oil vapor, or corrosive gases), frequency of use, and maintenance may accelerate sensor aging or affect core components. A regular maintenance plan tailored to the actual working environment should be established. Calibrate the product promptly if accuracy falls below the required standard.



ATTENTION!

Please save all your measurement data on an external device before returning the instrument to calibration and service. It might be necessary to reset the displays storage during calibration and service.

15 Maintenance

To clean the sensor and its accessories, you are recommended to use moist cloth only.



ATTENTION!

Do not use isopropyl alcohol to clean the display!

16 Disposal of waste



Electronic devices are recyclable material and do not belong in the household waste.

The sensor, the accessories and its packings must be disposed according to your local statutory requirements. The dispose can also be carried by the manufacturer of the product, for this please contact the manufacturer.

17 Warranty

Please find the warranty as a separated warranty card included with the instrument delivery.

The warranty does not cover any wear parts or consumables, therefore the UV lamp with limited lifetime as well as the internal filter are not covered by the warranty.

SUTO iTEC GmbH

Grißheimer Weg 21
D-79423 Heitersheim
Germany

Tel: +49 (0) 7634 50488 00
Email: sales@suto-itec.com
Website: www.suto-itec.com

SUTO iTEC (ASIA) Co., Ltd.

Room 10, 6/F, Block B, Cambridge Plaza
188 San Wan Road, Sheung Shui, N.T.
Hong Kong

Tel: +852 2328 9782
Email: sales.asia@suto-itec.com
Website: www.suto-itec.com